

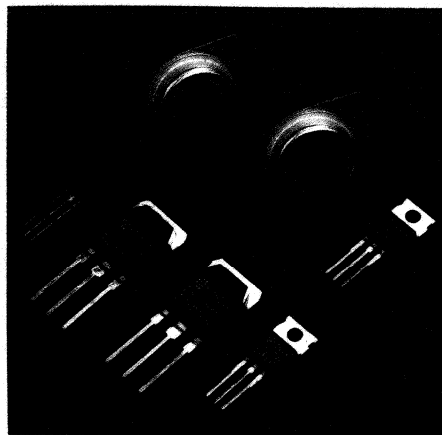

SFET Data Book



1987

PRINTED IN KOREA

Circuit diagrams utilizing SAMSUNG and/or SAMSUNG SEMICONDUCTOR & TELECOMMUNICATIONS CO., LTD., products are included as a means of illustrating typical semiconductor applications; consequently, complete information sufficient for construction purposes is not necessarily given. The information has been carefully checked and is believed to be entirely reliable. However, no responsibility is assumed for inaccuracies. Furthermore, such information does not convey to the purchaser of the semiconductor devices described herein any license under the patent rights of SAMSUNG and/or SAMSUNG SEMICONDUCTOR & TELECOMMUNICATIONS CO., LTD., or others. SAMSUNG and/or SAMSUNG SEMICONDUCTOR & TELECOMMUNICATIONS CO., LTD., reserve the right to change device specifications.

INTRODUCTION

Samsung Semiconductor and Telecommunication (SST) is a broad-line manufacturer of semiconductors that range from VLSI circuits such as memories (DRAM, SRAM, and EEPROM), microprocessors, gate arrays and programmable logic to transistors, linear circuits, CMOS logic and telecommunication products.

The SFET™ Power MOSFET Family extends SAMSUNG'S product line into the area of high current, high voltage MOS transistors.

The SFET Family is designed to offer solutions to many design problems. These products can be used as direct replacements for industry standard power MOSFETs: Improved ruggedness results in components that can also be used in more demanding application such as industrial control and power supply.

™SFET is a trademark of Samsung Semiconductor.

SAMSUNG SEMICONDUCTOR DATA BOOK LIST

- I. Semiconductor Product Guide**
- II. Transistor Data Book**
 - Vol. 1: Small Signal TR
 - Vol. 2: Bipolar Power TR
 - Vol. 3: TR Pellet
- III. Linear IC Data Book**
 - Vol. 1: Audio/Video
 - Vol. 2: Telecom/Industrial/Data Converter IC
- IV. MOS Product Data Book**
- V. High Performance CMOS Logic Data Book**
- VI. MOS Memory Data Book**
- VII. SFET Data Book**
- VIII. MPR Data Book**
- IX. CPL Data Book**
- X. Dot Matrix Data Book**

TABLE OF CONTENTS

1. Introduction	9
2. Quality and Reliability	15
3. Product Guide	43
4. Data Sheets	61
5. Test Circuits	423
6. Package Dimensions	431
7. Samsung Sales Offices and Manufacturer's Representatives	435

Introduction	1
Quality and Reliability	2
Product Guide	3
Data Sheets	4
Test Circuits	5
Package Dimensions	6
Samsung Sales Offices and Manufacturer's Representatives	7

INTRODUCTION 1

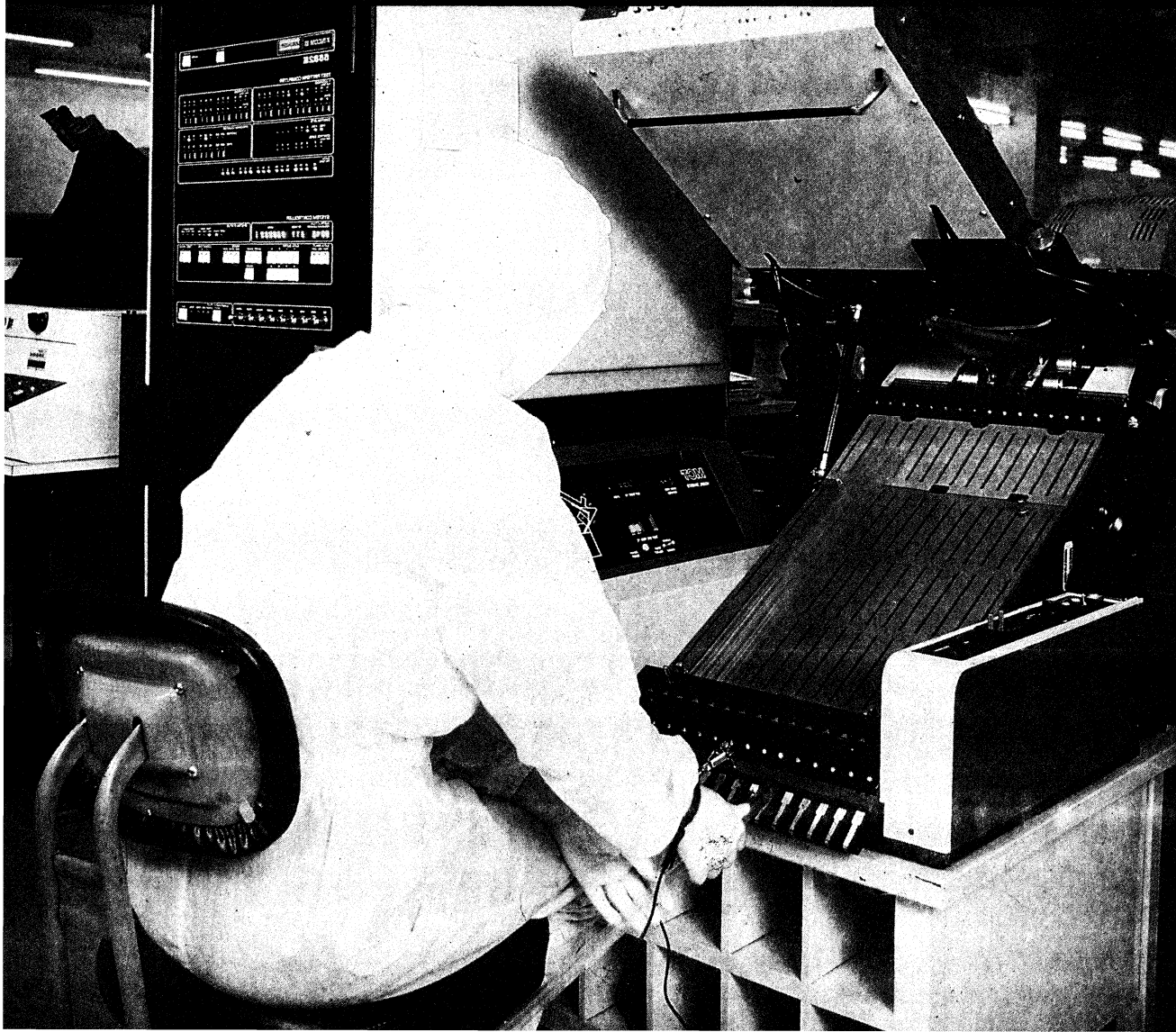
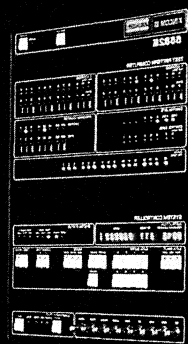

INTRODUCTION TO SAMSUNG'S SFET™ FAMILY

Since the introduction of the first Power MOSFET products in the mid-70's, these devices have emerged as widely accepted components in medium-to-high frequency power control applications. Advances in Doubled Diffused MOS (DMOS) process and circuit design technology, as well as our understanding of how to use these devices in practical applications, have fueled the rapid growth of these products. As MOSFET applications have grown, economies of scale possible with high volume state-of-the-art manufacturing facilities such as Samsung's have reduced the price of these components to the point where many new applications are possible.

Samsung, with the proprietary HDMOS (TM) process technology, has advanced the basic DMOS technology to yet another level of performance, equivalent to the development of 1 Mb DRAM's in memory technology.

HDMOS™ (high-performance DMOS) is a combination of process innovation and design innovation capable of producing devices with very high breakdown voltages (in excess of 1000V), the lowest on-resistance per unit chip area, lowest capacitance, fastest switching time and highest energy absorption capability under unclamped inductive load switching.

This data book describes the complete family of Samsung power MOSFET products. The 328 parts in this family, in both N- and P- channel, have breakdown voltages ranging from 60V up to 700V, with currents as large as 40A. Samsung is continually expanding this family with additional products announced quarterly.

FREEDOM FROM BIPOLAR LIMITATIONS

With this extensive family of power MOSFET products, designers of power conversion systems can finally dispense with traditional bipolar transistors and their associated constraints in terms of drive circuit complexity, reliability and switching speeds. Table 1 summarizes the advantages of MOSFET power transistors over older bipolar products.

Parameter	MOSFET	Bipolar
Input Impedence	High ($>10^9 \Omega$)	Medium ($\sim 10K \Omega$)
Gain	High ($>10^5$)	Medium (10~100)
Switching Frequency	High (>100 kHz)	Low (<10 kHz)
On Resistance ($R_{DS(on)}$)	Low	Lower
Off Resistance	High	High
Voltage Capability	1000V and growing	1200V
Ruggedness	Excellent (2J)	Fair
Cost	Low	Low
Max Operating Temperature	200°C	150°C

Table 1. Bipolar vs. MOSFET Power Transistors

DRIVING THE SFET

Bipolar transistors are current controlled devices, and therefore require large base currents for operation. This large base current produces an even larger current flowing from collector to emitter. Power MOSFETs, on the other hand, are voltage controlled devices. A relatively small voltage applied between gate and source results in a large current flowing from drain to source. The gate oxide electrically isolates the gate, and results in extremely high input impedance and low gate input leakage currents.

The result of these fundamental differences in device operation is that MOSFETS utilize much simpler drive circuits, and hence lower system cost in many applications.

Power MOSFETs are majority carrier devices, and therefore do not suffer from minority carrier storage time limitations as do bipolar transistors. As a result, MOSFETs offer much better switching performance (up to 1 MHz and beyond) than do bipolar transistors (which are limited to 20 KHz and below).

INTRODUCTION TO SAMSUNG'S SFET™ FAMILY

Unlike bipolar transistors, Power MOSFETs do not suffer from secondary breakdown. This is frequently a major limitation in the power handling capability of bipolar power transistors. The insensitivity to second breakdown is due to the negative temperature coefficient for carrier mobility in power MOSFETs. As current increases, the device heats up. However, unlike bipolar transistors, carrier mobility decreases with increasing temperature, acting to reduce any further current increase. This self-limiting mechanism reduces the susceptibility of MOSFETs to localized heating that can lead to device destruction.

CMOS COMPATIBLE PROCESSING

Some key features of HDMOS technology includes the use of CMOS local oxidation techniques for definition of active area, exclusive use of ion implantation to introduce dopants, the use of multiple diffused guard rings and polysilicon plates for breakdown voltage enhancement and built-in redundancy, and a tight geometry octagonal cell design. Figure 1 compares conventional DMOS technology and HDMOS technology with local oxidation.

Conventional approaches for growing field oxide in power MOSFETs result in very thick initial oxide of one micron, causing problems in pattern definition and contact metalization. With HDMOS technology, an alternate approach is used for defining the field oxide that is compatible with high density VLSI CMOS processes. This alternate approach is local oxidation.

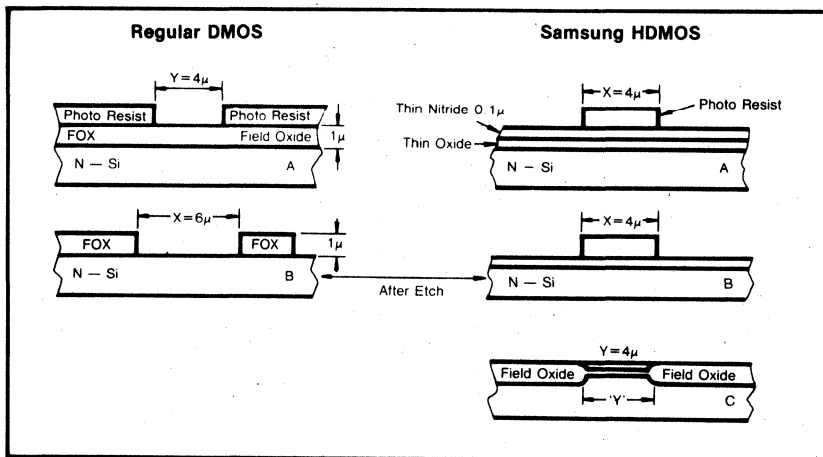

Figure 1: Conventional DMOS vs. HDMOS with Local Oxidation

By depositing and patterning a thin layer of silicon nitride, which selectively masks the silicon during oxide growth, the HDMOS features are more precisely defined. There is no undercutting of thick field oxide, and the resulting structure is more planar. This planar structure improves photolithographic resolution at other points in the process, and also reduces problems with metalization coverage. In addition, since one less etching sequence is required to pattern the thick field oxide, less chance exists of etch-induced pinholes in the field oxide. These pinholes reduce yields and device reliability.

In HDMOS, all impurities are introduced by ion implantation exclusively. This permits precise dopant control, eliminating variation in junction depths of both the main blocking junction and heavily doped source. Moreover, precise junction control allows the use of shallow junctions even in devices with blocking voltages well over 700V.

In N-channel devices, the main p-type junction well is defined by a unique double ion implant which significantly reduces parasitic bipolar transistor action. One implantation defines the p-well; the other is a heavier dose implant to create a central region of p+ in each cell. This reduces the sheet resistance of the well and prevents the parasitic NPN bipolar transistor from turning on.

This important advantage allows cell dimensions to be reduced to less than 12 microns, and cell densities to increase from 1 million to 2 million cells per square inch.

INTRODUCTION TO SAMSUNG'S SFET™ FAMILY

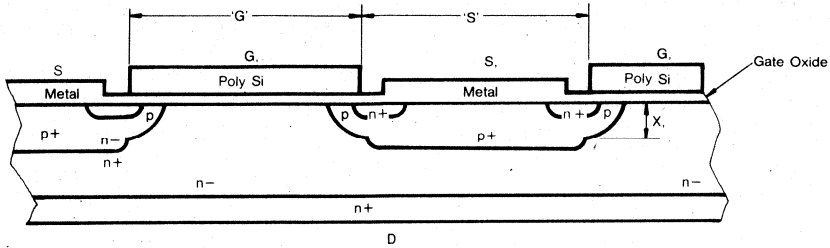

Figure 2: Extensive Use of Ion Implantation

UNIQUE GUARD-RING DESIGN

HDMOS employs a unique guard ring design to achieve high blocking voltages with a planar structure without consuming large amounts of silicon area. A sequence of multiple self-aligned guard rings is used so that if a defect shorts out any pair of rings, the design has sufficient redundancy to ensure the rest of the rings will hold the necessary blocking voltage. Figure 3 shows a cross section of the HDMOS guard ring structure.

In addition, to improve surface stability of the field-oxide surfaces between the rings, a polysilicon layer is deposited at the gate of the HDMOS device. This poly layer is used as a field plate in reducing the electrical field at the edges of the die. A proprietary metal termination design is used to clamp the potential at the edge of the die. This is done so no depletion lines will reach the scribe area and create breakdown voltage variation due to surface effects in the scribe.

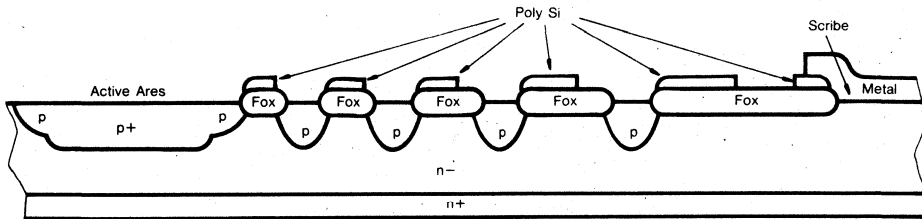

Figure 3: Multiple Self-aligned Guard Ring Structure

UNIQUE CELL DESIGN

Another key feature of HDMOS is an elongated octagonal cell design. This design minimizes parasitic NPN transistor base resistance, resulting in MOSFETs that are capable of withstanding high levels of inductive energy dissipation in inductive load switching without parasitic bipolar transistor turn-on.

HDMOS BENEFITS FOR DESIGNERS

For designers of power systems, HDMOS devices offer high performance under even exceptionally hostile circuit conditions. The exceptionally low input capacitance, as much as 35% lower than that of comparable devices, and low on-resistance are key to these performance advantages.

RUGGEDNESS

Unclamped inductive withstand energies of more than 2 J have been achieved for 700V (6A) devices, and 1.3 J for 500V devices (12A). Typical withstand energy levels for comparable devices is in the millijoule range. In practical terms, the strength of the Samsung devices allow a power control design engineer to be less concerned about stray inductance and voltage transients that can destroy conventional power MOSFETs, even in circuits which use voltage clamping techniques.

INTRODUCTION TO SAMSUNG'S SFET™ FAMILY

The ability of a power MOSFET to withstand high levels of inductive energy is not only a useful performance characteristic, but is also a measure of process quality. Poor process control leads to localized current crowding during inductive turn-off, which can lead to device failure during unclamped inductive load conditions.

Inductive load tests are used as a process control tool during final test. Samsung has found that test yields on conventional parameters such as breakdown voltage and leakage current were directly related to the results from inductive energy tests. Samsung tests 100% of its devices to a minimum inductive energy, and can select values that are specified by the customer.

An example is a two-phase step motor driven in the unipolar mode. The traditional solution is to clamp the peak V_{DS} that the power transistors see to below BV_{DSS} with an active or passive clamp circuit or snubber capable of dissipating 12.5W.

Even with the best motors, however, there is still some leakage reactance that is not coupled. When the transistor is turned off, the energy stored in the leakage inductance must be dissipated by the transistor, resulting in avalanche breakdown. For a typical motor, this leakage reactance might be $50\mu H$, resulting in an inductive energy of $625\mu J$ at 5A. Dissipation of the inductive energy in the MOSFET appears to be a very useful design approach. $625\mu J$ is well below the HDMOS power device's unclamped energy-handling capability and 12.5W of additional dissipation can be handled with proper thermal design.

FASTER SWITCHING SPEED

Lower CISS (Gate Input Capacitance) and CRSS (Miller Effect Capacitance), coupled with improved gate bus layout features, results in a 2-1 decrease in switching time, turn-on and turn-off delay times, as well as current and voltage rise and fall times. This speed improvement means higher frequency and more efficient operation in switching mode. For the designer, it also means reduced gate drive dissipation and reduced drive circuit complexity. The Miller effect interaction CRSS drops by 30%-a major benefit for gate drive circuit designs.

HDMOS boosts dV/dt capability by providing a better base-emitter short and reduced C_{jc} on the parasitic bipolar transistor. As a result, the designer can actually take advantage of the higher speed switching without compromising device reliability due to parasitic dV/dt turn on.

APPLICATION AREAS

With the availability of rugged, reliable HDMOS power MOSFET designers have "bullet proof" solutions for even the most difficult power system applications, including flyback and forward converters, and power factor correction in switch-mode power supplies (SMPS).

HDMOS devices can reliably satisfy the requirements for flyback and one-transistor forward converters operating off 240 Vac lines, and can extend the power handling capability of these designs up to 1000W.

Designers using these devices have no need to resort to exotic schemes such as transformer designs with 2-1 clamp to primary turns ration (and a 340 percent maximum duty cycle) in order to overcome the limitations of lower voltage devices.

The two-transistor forward converter has become a very popular topology for 240 Vac operation, and 500V HDMOS devices provide a reliable solution. However, in most cases, in addition to paying for two devices instead of one, the real issue is driving the upper leg since the gate drive must be at a potential which is close to the high voltage source.

The requirement for this second gate drive operating at several hundred volts above ground potential greatly increases the cost and complexity of the two transistor circuit. The design time and cost of producing an equivalent supply would be considerably lower if it could be done reliably with a one transistor implementation. This is exactly what a HDMOS Power MOSFET provides.

Another area that lends itself well to HDMOS solutions in SMPS is power factor corrections. For some time, this has been an important issue in military applications, and power correction solutions are now trickling down into the commercial arena as systems become more sophisticated and system interaction and power distribution problems become more acute.

A typical architecture for such a system utilizes a boost-converter preprocessor followed by a conventional dc/dc converter. The rectified input voltage is used as a current reference signal to command sinusoidal line current from the preprocessor.

The input bridge rectifier "unfolds" the half-sine pulses to provide very clean (power factor greater than 0.9) sinusoidal input line current. The dc output voltage can simultaneously be regulated, simplifying the remainder of the power-supply design.

This application requires a 450-500 Vdc bus voltage and a 600-800V power MOSFET. Conducted line emissions standards will get only more stringent as time goes on. The higher voltage HDMOS devices will be needed for the new power supply and motor control circuit designs.

QUALITY and RELIABILITY 2



QUALITY and RELIABILITY

INTRODUCTION

Samsung's SFET Power MOSFET products are among the most reliable in the industry. Extensive qualification, monitor, and outgoing product programs are used to scrutinize all areas of product quality and reliability. Additionally, stringent controls and subsequent supporting documentation are applied to every wafer fabrication and assembly lot.

Actual and predicted data are presented, and show the devices as a whole to have an impressive FIT* rate of 2 for standard lifetest stress conditions.

RELIABILITY THEORY

This section is chiefly concerned with reliability. However, quality will be mentioned briefly, as reliability and quality are strongly interrelated.

The first concern of a customer is with the quality of incoming product. For this reason, Samsung utilizes tight outgoing quality procedures to assure all customers receive quality products. Details are outlined in another section. Additionally, lot-by-lot stressing, regular reliability monitors, exhaustive product qualification testing, and rigorous in-line process controls (details in another section) are all utilized to guarantee Samsung products are of the highest grade. Quality is Samsung's number one priority.

2

*NOTE: FIT=Failures In Test, or failures in one billion, or 10^9 , device-hours.

QUALITY and RELIABILITY

QUALITY AND RELIABILITY PROGRAM

Three topics of prime concern regarding Samsung's quality programs are detailed below:

- A. Qualification Program
- B. Monitor Program
- C. Outgoing Quality Program

QUALIFICATION PROGRAM

In order for the SFET family to be qualified for mass production purposes, extensive reliability information has been compiled. The purpose was to simulate all relevant user conditions, via accelerated and standard methods, prior to customer shipments. In this way, the processing and design of SFET devices are "wrung-out", and reliability strongly established, to ensure all product is of the highest quality.

The stresses used for qualification are detailed in another section (Reliability Test Results). Very stringent LTPD levels were applied to the various tests to guarantee a product quality level in the upper tier of the Power FET market.

MONITOR PROGRAM

Twice per year devices duplicate their qualification tests to give long-term reliability data on SFET technology. In this way historical data is collected and analyzed over all part types and thus assures the customer of ongoing device quality. Not only is the product therefore verified at its initial stages, but trends are noted to track continual process stability. These results are summarized in reliability reports issued periodically by Samsung Semiconductor.

OUTGOING QUALITY PROGRAM

All wafer lots are required to pass a "QC-Reliability-Gate" prior to product shipment. The purpose is to track "lot-by-lot" quality and reliability to catch any potential product anomaly at the factory site.

The customer can then expect only quality material to be delivered from Samsung. Any lot that fails the procedure listed below is scrutinized heavily, to make sure that corrective action takes place immediately.

By paying such close attention to every lot, product costs are kept at a minimum. Samsung's customer return rate is extremely low, which is where our tough outgoing policy is most powerful. Such a tight clamp to protect our customers is how we can assure that all Samsung's products are released with the highest confidence level possible

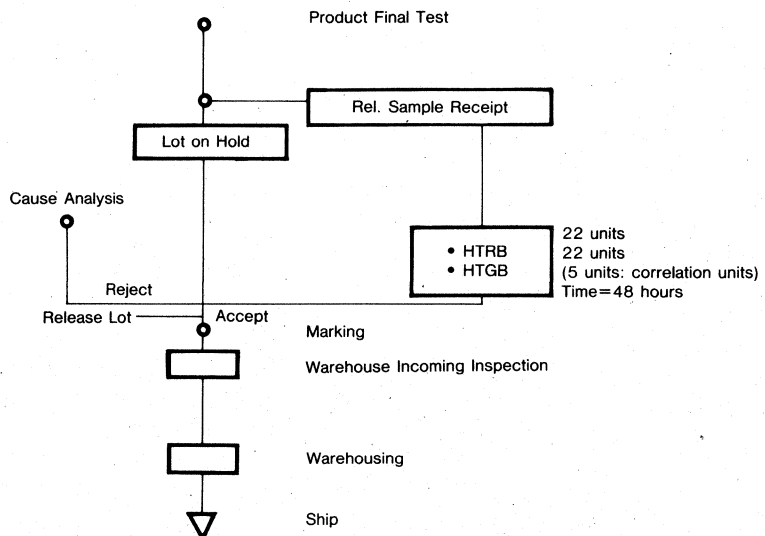

POWER FET OUTGOING FLOW

QUALITY and RELIABILITY

RELIABILITY AND PREDICTOR THEORY

RELIABILITY

Reliability can be loosely characterized as long-term product quality.

There are two types of reliability tests: those performed during design and development, and those carried out in production. The first type is usually performed on a small sample, but for long periods or under very accelerated conditions to investigate wearout failures and to determine tolerances and limits in the design process. The second type of tests is performed periodically during production to check, maintain, and improve the assured quality and reliability levels. All reliability tests performed by Samsung are under conditions more severe than those encountered in the field, and although accelerated, are chosen to simulate stresses that devices will be subjected to in actual operation. Care is taken to ensure that the failure modes and mechanisms are unchanged.

FUNDAMENTALS

A semiconductor device is very dependent on its conditions of use (e.g., junction temperature, ambient temperature, voltage, current, etc.). Therefore, to predict failure rates, accelerated reliability testing is generally used. In accelerated testing, special stress conditions are considered as parametrically related to actual failure modes. Actual operating life time is predicted using this method. Through accelerated stresses, component failure rates are ascertained in terms of how many devices (in percent) are expected to fail for every 1000 hours of operation. A failure rate versus time of activity graph is shown below (the so-called "bath tub curve").

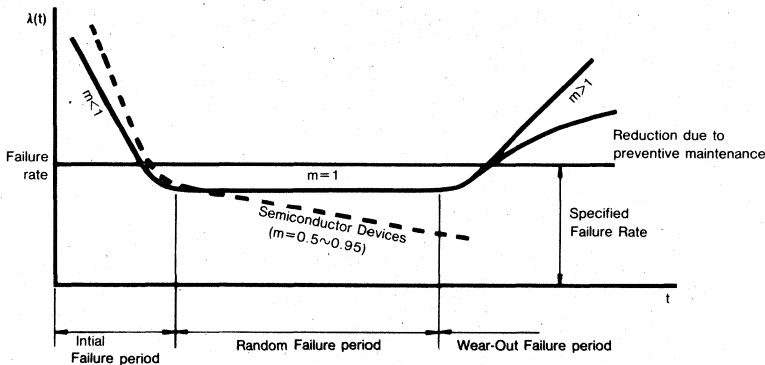

Figure 4: Failure Rate Curve ("Bath Tub Curve")

During the initial time period, products are affected by "infant mortality", intrinsic to all semiconductor technologies. End users are very sensitive to this parameter, which causes early assembly/operation failures of their system. Periodically Samsung reviews and publishes life time results. The goal is a steady shift of the limits as shown below.

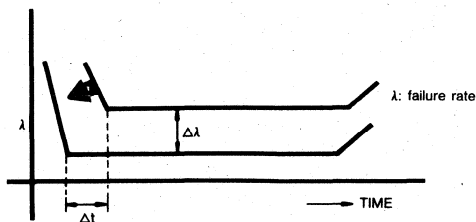

Figure 5: Failure Rate

QUALITY and RELIABILITY

ACCELERATED HUMIDITY TESTS

To evaluate the reliability of products assembled in plastic packages, Samsung performs accelerated humidity stressing, such as the Pressure Cooker Test (PCT) and Wet High Temperature Life Test (WHTL).

Figure 6 shows some results obtained with these tests, which illustrate the improvements in recent years. These improvements result mainly from the introduction of purer molding resins, new process methods, and improved cleanliness

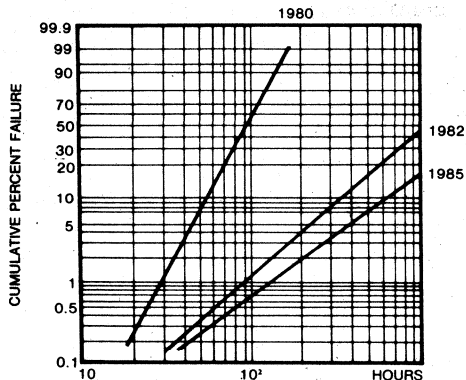

Figure 6: Improvement in Humidity Tests

ACCELERATED TEMPERATURE TESTS

Accelerated temperature tests are carried out at temperatures in a range from 75°C to 200°C for up to 1000 hours. These tests allow Samsung to evaluate reliability rapidly and economically, as failure rates are strongly dependent on temperature.

The validity of these tests is demonstrated by the good correlation between data collected in the field and laboratory results obtained using the Arrhenius model. Figure 7 shows the relationship between failure rates and temperatures obtained with this model.

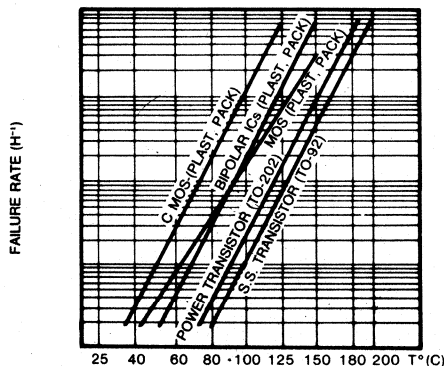

Figure 7: Failure Rate versus Temperature

QUALITY and RELIABILITY

FUNDAMENTAL THEORY FOR ACCELERATED TESTING

The accelerated life test is powerful because of its strong relation to failure physics. Arrhenius model, which is generally used, is explained below.

1. Arrhenius model

This model can be applied to accelerated Operating Life Tests and uses absolute (Kelvin) temperatures.

$$L = A + E_a / K \cdot T_j$$

L : Lifetime

A : Constant

E_a : Activation Energy

T_j : Absolute Junction temperature

K : Boltzman's constant

If life L1 and L2 correspond to T1, T2:

$$L1 = L2 \exp \left\{ \frac{E_a}{K} \left(\frac{1}{T1} - \frac{1}{T2} \right) \right\}$$

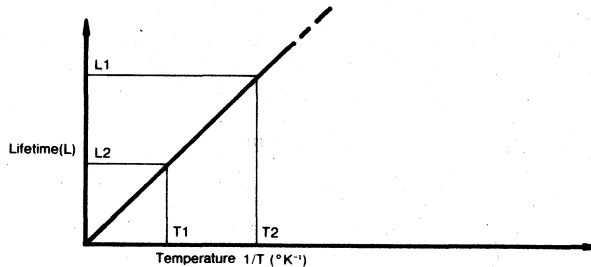

The actual junction temperature should be used and can be computed using the following relationship:

$$T_j = T_a + (P \times \theta_{ja})$$

Where T_j = Junction Temperature

T_a = Ambient temperature

P = Actual power consumption

θ_{ja} = Junction to Ambient thermal resistance (typically 100 degrees celsius/watt for a 16-Pin PDIP).

2. Activation Energy Estimate

Clearly the choice of an appropriate activation energy, E_a, is of paramount importance. The different mechanisms which could lead to circuit failure are characterized by specific activation energies whose values are published in the literature. The Arrhenius equation describes the rate of many processes responsible for the degradation and failure of electronic components. It follows that the transition of an item from an initially stable condition to a defined degraded state occurs by a thermally activated mechanism. The time for this transition is given by an equation of the form:

$$MTBF = B \exp(E_a / KT)$$

MTBF = Mean time between failures

B = Temperature-independent constant

MTBF can be defined as the time to suffer a device degradation. The dramatic effect of the choice of the E_a value can be seen by plotting the MTBF equation. The acceleration effect for a 125°C device junction test with respect to 70°C actual device junction operation is equal to 1000 for E_a = 1eV and 7 for E_a = 0.3eV.

QUALITY and RELIABILITY

Some words of caution are needed about published values of E_a :

- A. They are often related to high-temp tests where a single E_a (with high value) mechanism has become dominant.
- B. They are specifically related to the devices produced by that supplier (and to its technology) for a given period of time.
- C. They could be modified by the mutual action of other stresses (voltage, mechanical, etc.)
- D. Field device-application conditions should be considered.

(Activation energy for each failure mode)

Failure Mechanism	E_a
Contamination	1~1.4 eV
Polarization	1 eV
Aluminum Migration	0.5~1 eV
Trapping	1 eV
Oxide Breakdown	0.3 eV
Silicon Defects	0.3~0.5 eV

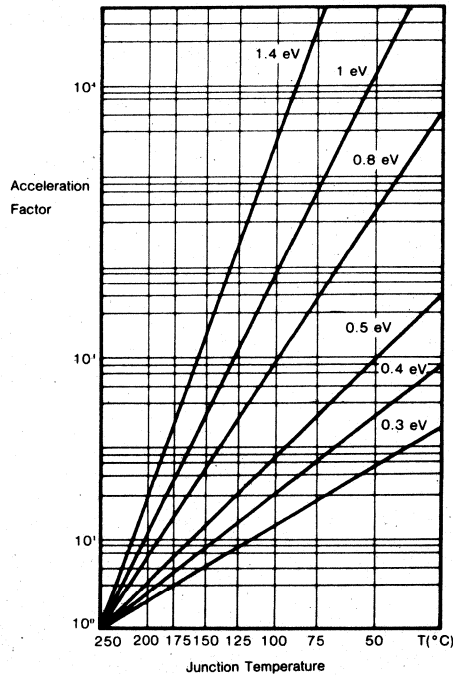
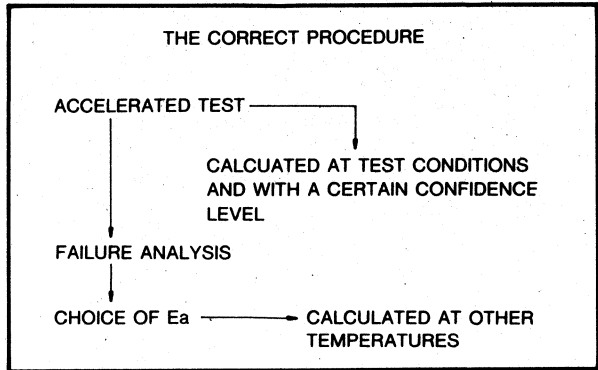

Figure 8: Life Hours

QUALITY and RELIABILITY

Failure Rate Predication

Accelerated testing defines the failure rate of products. By derating the data at different conditions, the life expectancy at actual operating conditions can be predicted. In its simplest form the failure rate (at a given temperature) is:

$$FR = \frac{N}{DH}$$

Where FR=Failure Rate

N =Number of failures

D =Number of components

H =Number of testing hours

If we intend to determine the FR at different temperatures, an acceleration factor must be considered. Some failure modes are accelerated via temperature stressing based upon the accelerations of the Arrhenius Law.

For two different temperatures:

$$F.R (T1)=FR (T2) \exp \left\{ \frac{Ea}{K} \left(\frac{1}{T2} - \frac{1}{T1} \right) \right\}$$

FR (T1) is a point estimate, but to evaluate this data for an interval estimate, we generally use X² (chi square) distribution. An example follows:

Failure Rate Elaluation

Unit: %/1000HR

Dev. x Hours at 125°C	Fail	Failure Rate at 60% Confidence Level			
		Point Estimate	85°C	70°C	55°C
1.7 × 10 ⁶	2	0.18	0.0068	0.0018	0.00036

The activation energy, from analysis, was chosen as 1.0 eV based upon test results. The failure rate at the lower operating temperature can be extrapolated by an Arrhenius plot.

QUALITY and RELIABILITY

RELIABILITY TESTS

Samsung has established a comprehensive reliability program to monitor and ensure the ongoing reliability of the SFET Power MOSFET family. This program involves not only reliability data collection and analysis on existing parts, but also rigorous in-line quality controls for all products.

Listed below are details of tests performed to ensure that manufactured product continues to meet Samsung's stringent quality standards. In-line quality controls are reviewed extensively in later sections.

The tests run by the Quality Department are accelerated tests, serving to model "real world" applications through boosted temperatures, voltages, and/or humidities. Accelerated conditions are used to derive device knowledge through means quicker than that of typical application situations. These accelerated conditions are then used to assess differing failure rate mechanisms that correlate directly with ambient conditions.

Following are summaries of various stresses (and their conditions) run by Samsung on SFET devices.

High Temperature Reverse Bias (80% max V_{DS} , $V_{GS}=0V$, 150°C, static)

For this test, device integrity is checked through stressing of the main blocking junction at an elevated temperature and voltage. Overall product stability is investigated through leakage current monitoring; low leakage indicates good integrity.

High Temperature Gate Bias ($V_{GS}=20V$, $V_{DS}=0V$, 150°C, static)

HTGB is utilized to analyze gate oxide and junction stability over extended periods of accelerated temperatures and voltages. This is crucial as it is used to establish integrity at a point of high device stress.

Intermittent Operating Life (P_{MAX} , 25°C, 2 min on/2 min off)

This test is normally applied to scrutinize die bond thermal fatigue. A stressed device undergoes an "on" cycle, where there is thermal heating due to power dissipation, and an "off" cycle, where there is thermal cooling due to lack of inputted power. Die attach (between die and package) and bond attach (between wire and die) are the critical areas of concern.

Wet High Temperature Reverse Bias (80% max V_{DS} , $V_{GS}=0V$, 85°C, 85% R.H., static)

Wet high temperature reverse bias test is used to accelerate failure mechanisms by applying static bias on alternate pins at high temperature and humidity ambient (85°C/85% R.H.). This test checks for resistance to moisture penetration by using an electrolytic principle to accelerate corrosive mechanisms.

Pressure Cooker Test (Unbiased, 121°C, 15 PSIG, 100% R.H.)

The Pressure Cooker Test checks for resistance to moisture penetration. A highly pressurized vessel is used to force water (thereby promoting corrosion) into packaged devices located within the vessel.

High Temperature Storage (Unbiased, 150°C)

High Temperature Storage is utilized to test for both package and die weaknesses. For example, sensitivities to ionic contamination and bond integrity are closely scrutinized.

Temperature Cycling (Unbiased, -65°C to +150°C, air)

This stress uses a chamber with alternating temperatures of -65°C and +150°C (air ambient) to thermally cycle devices within it. No bias is applied. The cycling checks for mechanical integrity of the packaged device, in particular bond wires and die attach, along with metal/polysilicon microcracks.

Thermal Shock (Unbiased, -65°C to +150°C, liquid)

This stress uses a chamber with alternating temperatures of -65°C to +150°C (liquid ambient) to thermally cycle devices within it. No bias is applied. The cycling is very rapid, and primarily checks for die/package compatibility.



QUALITY and RELIABILITY

RELIABILITY TEST RESULTS

This section is divided into two parts-actual and predicted test results. Actual test results are those derived via accelerated stressing done by the QC Department. Predicated test results are calculated by taking actual test results and de-rating them using statistical and mathematical models to determine device performance in "real-time" user conditions.

ACTUAL TEST RESULTS

Stress	Conditions	Number of Devices	Number of Device Hours/Cycles	Number of Failures	Failure Rate (See Predicted Test Results)	MTBF* [years] (See Predicted Test Results)
HTRB	80% max. V_{DS} , $V_{GS}=0V$, 150°C Static	990	988,668	9	4 FIT	28,617
HTGB	$V_{GS}=20V$, $V_{DS}=0V$, 150°C Static	990	990,000	2	1 FIT	114,469
IOL	P_{max} , 2min on/2 min off 25°C	342	342,000	2	0.91%/1k Hrs	12.6
WHTRB	80% max. V_{DS} , $V_{GS}=85^\circ C$, 85% R.H., Static	342	341,000	2	43 FIT	2,662
PCT	121°C, 15 PSIG, 100% R.H.	240	23,040	0	3.99%/1k Hrs	2.9
HTS	150°C	684	684,000	1	1 FIT	114,469
Temperature Cycle	-65°C to 150°C, air-to-air	456	273,200	1	0.74%/1k Cyc	15.5
Thermal Shock	-65°C to 150°C liquid-to-liquid	228	136,800	0	0.672%/1kCyc	17.0

Note: MTBF is defined as "Mean Time Between Failures", and is the mathematical inverse of FIT.

QUALITY and RELIABILITY

Predicted Test Results

The Arrhenius Equation, which is reviewed in another section of this chapter, can be applied to derive typical "user-condition" device failure rates.

Stress: HTRB

$$\frac{988,668}{9} \text{ device-hours at } 150^{\circ}\text{C}$$

$$\frac{\text{failures}}{\text{failures}}$$

Average activation energy = 1.0 eV

Stress: HTGB

$$\frac{990,000}{2} \text{ device-hours at } 150^{\circ}\text{C}$$

$$\frac{\text{failures}}{\text{failures}}$$

Average activation energy = 1.0 eV

De-rating to user-conditions yields:

55°C Operation

Equivalent Device Hours	% Failures per 1000 Hours (60% UCL)	FITs	MTBF (Years)
2.79×10^9	0.0004	4	28,617

De-rating to user-conditions yields:

55°C Operation

Equivalent Device Hours	% Failures per 1000 Hours (60% UCL)	FITs	MTBF (Years)
2.80×10^9	0.0001	1	114,469

70°C Operation

Equivalent Device Hours	% Failures per 1000 Hours (60% UCL)	FITs	MTBF (Years)
5.94×10^8	0.0017	17	6,733

70°C Operation

Equivalent Device Hours	% Failures per 1000 Hours (60% UCL)	FITs	MTBF (Years)
5.95×10^8	0.0005	5	22,894

90°C Operation

Equivalent Device Hours	% Failures per 1000 Hours (60% UCL)	FITs	MTBF (Years)
9.19×10^7	0.0113	113	1,013

90°C Operation

Equivalent Device Hours	% Failures per 1000 Hours (60% UCL)	FITs	MTBF (Years)
9.21×10^7	0.0034	34	3,367

Stress: IOL

$$\frac{342,000}{2} \text{ device-hours}$$

$$\frac{\text{failures}}{\text{failures}}$$

% Failures per 1000 Hours (60% UCL)	FITs	MTBF (Years)
0.9064	9064	12.6

Stress: WHTRB*

$$\frac{341,000}{2} \text{ device-hours}$$

$$\frac{\text{failures}}{\text{failures}}$$

Equivalent Device Hours	% Failures per 1000 Hours (60% UCL)	FITs	MTBF (Years)
7.20×10^7	0.0043	43	2,662

* Peck and Zierdt's Model is applied for failure rate prediction. Accelerated conditions are de-rated to 55°C and 50% R.H. conditions.

QUALITY and RELIABILITY

Stress: PCT

23,040 device-hours
0 failures

% Failures per per 1000 Cycles (60% UCL)	FITs	MTBF (Years)
3.9905	39,905	2.9

Stress: Temperature Cycle

273:200 device-cycles
1 failures

% Failures per per 1000 Cycles (60% UCL)	FITs	MTBF (Years)
0.7394	7,394	15.5

Stress: Thermal Shock

136,800 device-cycles
0 failures

% Failures per per 1000 Cycles (60% UCL)	FITs	MTBF (Years)
0.6720	6,720	17.0

Shress: HTS

684,000 device-hours at 150°C
1 failures
Activation energy = 1.0eV

55°C Operation

Equivalent Device Hours	% Failures per 1000 Hours (60% UCL)	FITs	MTBF (Years)
1.93×10^9	0.0001	1	114,469

70°C Operation

Equivalent Device Hours	% Failures per 1000 Hours (60% UCL)	FITs	MTBF (Years)
4.11×10^8	0.0005	5	22,894

90°C Operation

Equivalent Device Hours	% Failures per 1000 Hours (60% UCL)	FITs	MTBF (Years)
6.36×10^7	0.0032	32	3,577

QUALITY and RELIABILITY

PROCESS CONTROL

GENERAL PROCESS CONTROL

The general process flow in Samsung is shown in Figure 9. This illustration contains the standard process flow from incoming parts and materials to customer shipment.

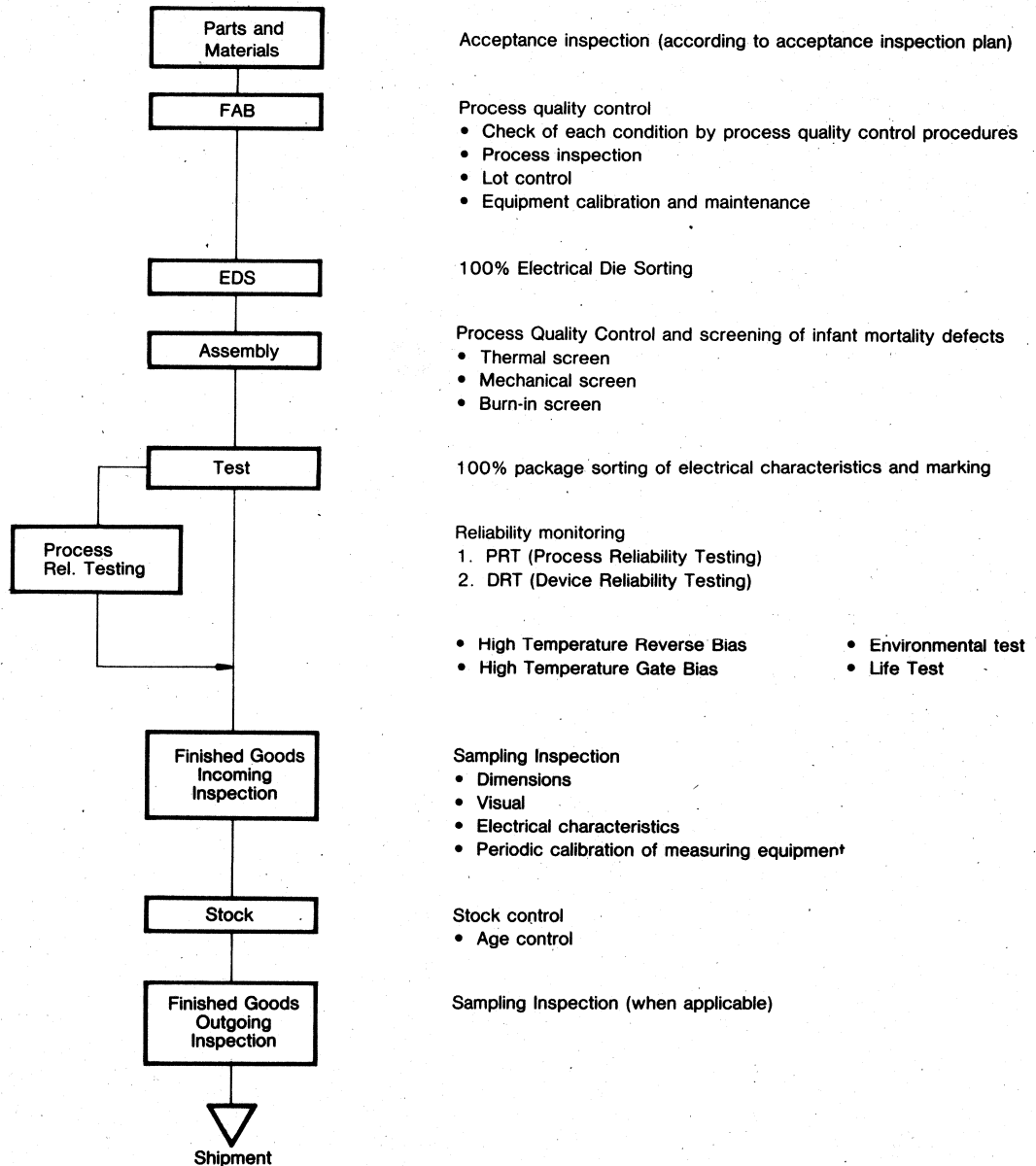

Figure 9: General Process Flow Chart

QUALITY and RELIABILITY

WAFER FABRICATION

Process Controls

The Quality Control program utilizes the following methods of control to achieve its previously stated objectives: process audits, environmental monitors, process monitors, lot acceptance inspections, and process integrity audits.

Definitions

The essential method of the Quality Control Program is defined as follows:

1. Process audit-Performed on all operations critical to product quality and reliability.
2. Environmental monitor-Monitors concerning the process environment; *i.e.*, water purity, temperature, humidity, particle counts.
3. Process monitor-Periodic inspection at designated process steps for verification of manufacturing inspection and maintenance of process average. These inspections provide both attribute and variable data.
4. Lot acceptance-Lot-by-lot sampling. This sampling method is reserved for those operations deemed as critical and require special attention.

Environmental Monitor

Process	Control Item	Spec. Limit	Insp. Frequency
Clean Room	<ul style="list-style-type: none"> • Temperature • Humidity • Particle • Air Velocity 	<ul style="list-style-type: none"> • Individual Spec. • Individual Spec. • Individual Spec. • Individual Spec. 	<ul style="list-style-type: none"> 24 Hrs. 24 Hrs. 24 Hrs. 24 Hrs.
D.I. Water	<ul style="list-style-type: none"> • Particle • Bacteria • Resistivity 	<ul style="list-style-type: none"> • 5 ea/50ml (0.8μ) • 50 colonies/100ml (0.45μ) • Main (Line): More than 16 Mohm-cm • Using point: More than 14 Mohm-cm 	<ul style="list-style-type: none"> 24 Hrs. Weekly 24 Hrs. 24 Hrs.

*Instruments

- FMS (Facility Monitoring System) HIAC/ROYCO
- CPM (Central Particle Monitoring System-Dan Scientific)
- Liquid Dust Counter Etch Rate
- Filtration System for Bacterial check
- Air Particle counter
- Air Velocity meter

Process Monitor

Process	Control Item	Spec. Limit	Insp. Frequency
Photo	<ul style="list-style-type: none"> • Aligner N₂ Flow Rate • Aligner Vacuum • Aligner Air • Aligner Pressure • Aligner Intensity • Coater Soft Bake Temperature Vacuum 	<ul style="list-style-type: none"> • Individual Spec. • Individual Spec. • Individual Spec. • Individual Spec. • Individual Spec. • Individual Spec. • Individual Spec. • Individual Spec. 	<ul style="list-style-type: none"> Once/Shift Once/Shift Once/Shift Once/Shift Once/Shift Once/Shift Once/Shift Once/Shift
Etch	<ul style="list-style-type: none"> • Etchant Temp. • Etch Rate • Spin Dryer N₂ Flow RPM • Hard Bake Temp. N₂ Flow 	<ul style="list-style-type: none"> • Individual Spec. • Individual Spec. • Individual Spec. • Individual Spec. • Individual Spec. • Individual Spec. 	<ul style="list-style-type: none"> Once/Shift Once/Shift Once/Shift Once/Shift Once/Shift Once/Shift

QUALITY and RELIABILITY

Process Monitor (Continued)

Process	Control Item	Spec. Limit	Insp. Frequency
Thin Film	<ul style="list-style-type: none"> Cooling Water Temp. Thickness 	<ul style="list-style-type: none"> 26±3°C Individual Spec. 	<ul style="list-style-type: none"> Once/Shift Once/Shift
CVD	<ul style="list-style-type: none"> Pin Hole Thickness 	<ul style="list-style-type: none"> Individual Spec. Individual Spec. 	<ul style="list-style-type: none"> Once/Shift Once/Shift
Diffusion	<ul style="list-style-type: none"> Tube Temp. C-V Plot Run Tube Sheet Resistance Thickness 	<ul style="list-style-type: none"> Individual Spec. Individual Spec. Individual Spec. Individual Spec. Individual Spec. 	<ul style="list-style-type: none"> Once/Shift Once/Shift Once/10days Once/Shift Once/Shift

Raw Material Incoming Inspection

1. Mask Inspection

Defect Detection	<ul style="list-style-type: none"> Pinhole & Clear-extension Opaque Projections & Spots Scratch/Particle/Stain Substrate Crack/Glass-chip Others 	All Masks	<ul style="list-style-type: none"> Defect Size ≤ 1.5μm Defect Density ≤ 0.124EA/cm²
Registration	<ul style="list-style-type: none"> Run-out (X-Y Coordinate) Orthogonality Drop-in Accuracy Die Fit/Rotation 	20% <ul style="list-style-type: none"> All New Masks 	±0.75μm ±0.75μm ±0.50μm ±0.50μm
Critical Dimension	<ul style="list-style-type: none"> Critical Dimension 	All Masks	Purchasing Spec.

* Instrument

- Auto mask inspection system for defect-detection (NJS 5MD-44)
- Comparator for registration (MVG 7X7)
- Automatic linewidth measuring system for CD (MPV-CD)

2. Wafer Inspection

Purpose	Insp. Items	Sample	Remarks
Structural	<ul style="list-style-type: none"> Crystallographic Defect 	All Lots	<ul style="list-style-type: none"> Sirtl Etch
Electrical	<ul style="list-style-type: none"> Resistivity Conductivity 	All Lots	<ul style="list-style-type: none"> Monitor Water
Dimensional	<ul style="list-style-type: none"> Thickness Diameter Orientation Flatness 	All Lots	TTV, NTV, Epi-thickness TIR (FPD) Local Slope
Visual	<ul style="list-style-type: none"> Surface Quality Cleanliness 	All Lots	Purchasing Spec.

* Instrument

- 4 point probe for resistivity (Kokusai VR-40A, Tencor sonogage, ASM AFPP)
- Flatness measuring system (Siltec)
- Epi. layer thickness gauge (Digilab FTG-12, Qualimatic S-100)
- Automatic Surface Insp. System (Aeronca Wis-150)
- Non-contact thickness gauge (ADE6034)

QUALITY and RELIABILITY

In-Process Quality Inspection (FAB)

1. Manufacturing Section

Process Step	Process Control Insp.	Frequency
Oxidation	Oxide Thickness	All Lots
Diffusion	Oxide Thickness Sheet Resistance Visual	All Lots All Lots All Lots
Photo	Critical Dimension Visual Mask Clean Inspection	All Lots (MOS) All Lots All Masks with Spot Light (MOS) or Microscope (BIP)
Etch	Critical Dimension Visual	All Lots All Wafers
Thin Film	Metal Thickness Visual	All Lots All Lots
Ion Implant	Sheet Resistance	All Lots (Test Wafer)
Low Temp. Oxide	Thickness	All Lots
	Visual	All Lots
E-Test	Electrical Characteristics	All Lots
Fab. Out	Visual	All Wafers

2. FAB, QC Monitor/Gate

Process Step	FAB, QC Insp.	Frequency
Oxidation	Oxide Thickness C-V Test on Tubes Visual	Once/Shift Once/10 Days and After CLN. Once/Shift
Diffusion	Oxide Thickness C-V Test on Tubes Visual	Once/Shift Once/10 Days and After CLN. Once/Shift
Photo	Critical Dimension Visual Mask CLN Inspection	All Lots (MOS) Once/Shift All Masks After 10 Times Use
Etch	Critical Dimension Visual	All Lots (MOS) All Lots
Thin Film	C-V Test on Tubes on Lots Reflectivity	Once/10 Days and After CLN. Once/Shift Once/Shift
Low Temp. Oxide	Refractive Index, Wt% of Phosphorus Visual	1 Test Wafer/Lot 1 Test Wafer/Lot 1 Test Wafer/Lot
E-Test	Measuring Data	All Lots
Calibration	Instrument for Thickness and C.D Measuring	Once/week

QUALITY and RELIABILITY

3. Photo/Etch process quality control

Process Flow	Process Step	MFG. Control Item	QC Monitor/Gate
	Prebake	Oven PM, Temperature Time	Oven-Particle Temp N ₂ Flow Rate
	Photo Resist (PR) —spin	Thickness Machine PM	
	Soft Bake	Oven PM, Temperature Time	Temp. N ₂ Flow Rate
	Align/Expose	Light Uniformity Alignment, Focus Test Mask Clean Inspection Mask Clean Exposure Light Intensity	Light Intensity Mask Clean Insp.
	Develop	Equipment PM Solution Control	Vacuum
	Develop Check	PRC.D.'S Alignment Particles Mask and Resist Defects	
	QC Inspection		Critical Dimension
	Hard Bake	Oven PM, Temperature Time	Temp. N ₂ Flow Rate
	Etch	Etch rate, Equipment PM & Settings, Etch Time to Clear	Etchant Temp. Etch Rate
	Inspection	Over/Under	
	PR Strip	Machine-PM	
	Final Check	C.D.'S Over and under Etch, Particles, PR Residue, Defects, Scratches	
	QC Inspection		Same as Final Check, However, More Intense on limited Sample Basis. (AQL 6.5%)

4. Reliability-related Interlayer Dielectric, Metallization, and Passivation Process Quality Control Monitor

Item	Frequency
Wt% Phosphorus Content of the Dielectric Glass	1/Shift
Metallization Interconnect	1/Month
Al Step Coverage	1/Month
Metallization Reflectivity	1/Shift
Passivation Thickness and Composition	1/Shift
Thin Film Defect Density	1/Shift

QUALITY and RELIABILITY

Figure 10: General Wafer Fabrication Flow

Process Flow	Process Step	Major Control Item
	Wafer and Mask Input	
	Starting Material Incoming Inspection	Mask: (See mask Inspection) Wafer: (See wafer Inspection)
	Wafer Sorting and Labelling	Resistivity
	Initial Oxidation	Oxide Thickness
	Photo	<ul style="list-style-type: none"> • (See manufacturing section) • (See FAB, QC Monitor/gate)
	Inspection	<ul style="list-style-type: none"> • Critical Dimension • Visual/Mech — Major: AQL 1.0% — Minor: AQL 6.5%
	QC Gate	<ul style="list-style-type: none"> • Critical Dimension
	Etch	<ul style="list-style-type: none"> • (See manufacturing section) • (See FAB, QC Monitor/gate)
	Inspection	<ul style="list-style-type: none"> • Critical Dimension • Visual/Mech — Major: AQL 1.0% — Minor: AQL 6.5%
	QC Gate	<ul style="list-style-type: none"> • Critical Dimension • Visual/Mech
	Diffusion Metalization	<ul style="list-style-type: none"> • (See in-process Quality Inspection)
	E-test	<ul style="list-style-type: none"> • Electrical Characteristics

2

QUALITY and RELIABILITY

FIGURE 10. General Wafer Fabrication Flow (Continued)

Process Flow	Process Step	Major Control Item
◊	QC Gate	<ul style="list-style-type: none"> • Electrical Characteristics
○	Back-Lap	<ul style="list-style-type: none"> • Thickness
○	Back Side Evaporation	<ul style="list-style-type: none"> • Thickness, Time Evaporation Rate
□	Final Inspection	<ul style="list-style-type: none"> • All Wafers Screened (Visual/Mech)
◊	QC Fab. Final Gate	<ul style="list-style-type: none"> • Visual/Mech. <ul style="list-style-type: none"> — Major: AQL 1.0% — Minor: AQL 6.5%
○	EDS (Electrical Die Sorting)	
◊	QC Gate	<ul style="list-style-type: none"> • Function Monitor
○	Sawing	
□	Inspection	<ul style="list-style-type: none"> • Chip Screen
◊ ↓ Die Attach	QC Final Inspection	<ul style="list-style-type: none"> • AQL 1.0% <ul style="list-style-type: none"> • Fab. Defect • Test Defect • Sawing Defect

QUALITY and RELIABILITY

ASSEMBLY

The process control and inspection points of the assembly operation are explained and listed below:

1. Die Inspection

Following 100% inspection by manufacturing, in-process Quality Control samples each lot according to internal or customer specifications and standards.

2. Die Attach Inspection:

Visual inspection of samples is done periodically on a machine/operator basis. Die Attach techniques are monitored and temperatures are verified.

3. Die Shear Strength:

Following Die Attach, Die Shear Strength testing is performed periodically on a machine/operator basis. Either manual or automatic die attach is used.

4. Wire Bond Inspection:

Visual inspection of samples is complemented by a wire pull test done periodically during each shift. These checks are also done on a machine/operator basis and \bar{X} R data is maintained.

5. Pre-Seal/Pre-Encapsulation Inspection:

Following 100% inspection of each lot, samples are taken on a lot acceptance basis and are inspected according to internal or customer criteria.

6. Seal Inspection:

Periodic monitoring of the sealing operation checks the critical temperature profile of the sealing oven for both glass and metal seals.

7. Post-Seal Inspection:

Subsequent to a 100% visual inspection, In-Process Quality Control samples each for conformance to visual criteria.

8. General Assembly Flow is shown in Figure 11.

Sampling Plans

1. Sampling plans are based on an AQL (Acceptable Quality Level) concept and are determined by internal or by customer specifications.

2. Raw Material Incoming Inspection.

QUALITY and RELIABILITY

2. Raw Material Incoming Inspection (continued)

Material	Inspection Item	Acceptable Quality Level
Lead Frame	<ol style="list-style-type: none"> 1) Visual Inspection 2) Dimension Inspection 3) Function Test 4) Work Test 	LTPD 10%, C=2 LTPD 20%, C=0 LTPD 20%, C=0 LTPD 20%, C=0
Wafer	<ol style="list-style-type: none"> 1) Visual Inspection 	AQL 0.65%
Au/Al Wire	<ol style="list-style-type: none"> 1) Visual Inspection 2) Bond Pull Strength Test 3) Bondability Test 4) Chemical Composition Analysis 	n:5, C=0 n:13, C=0 Critical Defect: 0.65% Major Defect: 1.0% Minor Defect: 1.5% n:5, C=0
Molding Compound	<ol style="list-style-type: none"> 1) Visual Inspection 2) Moldability Test 3) Chemical Composition Analysis 	n:5, C=0 Critical Defect: 0.15% Major Defect: 1.0% Minor Defect: 1.5% n:5, C=0
Packing Tube & Pin	<ol style="list-style-type: none"> 1) Visual Inspection 2) Dimension Inspection 3) Electro-Static Inspection 4) Hardness Test 	LTPD 15%, C=2 LTPD 15% C=2 n:5, C=0 n:5, C=0
Solder	<ol style="list-style-type: none"> 1) Visual Inspection 2) Weight Inspection 3) Chemical Composition Analysis 	LTPD 20% C=0 LTPD 20% C=0 LTPD 20% C=0
Flux	<ol style="list-style-type: none"> 1) Acidity Test 2) Specific Gravity Test 3) Chemical Composition Analysis 	LTPD 20% C=0 LTPD 20% C=0 LTPD 20% C=0
Solder Preform	<ol style="list-style-type: none"> 1) Visual Inspection 2) Work Test 3) Chemical Composition Analysis 	AQL 1.0% AQL 1.0% AQL 1.0%
Coating Resin	<ol style="list-style-type: none"> 1) Visual Inspection 2) Work Test 3) Chemical Composition Analysis 	AQL 1.0% AQL 1.0% AQL 1.0%
Marking Ink	<ol style="list-style-type: none"> 1) Work Test 2) Mark Permanency Test 	Critical Defect: 0.15% Major Defect: 1.0% Minor Defect: 1.5% n:5, C=0
Chip Carrier	<ol style="list-style-type: none"> 1) Visual Inspection 2) Dimension Inspection 3) Electro-Static Inspection 4) Hardness Test 	LTPD 15% C=2 LTPD 15% C=0 n:5, C=0 n:5, C=0
Vinyl Pack	<ol style="list-style-type: none"> 1) Visual Inspection 2) Work Test 3) Electro-Static Inspection 	LTPD 20% C=0 LTPD 20% C=0 LTPD 15% C=0
Ag Epoxy	<ol style="list-style-type: none"> 1) Work Test 2) Chemical Composition Analysis 	n:8 C=0 n:8 C=0
Letter Marking	<ol style="list-style-type: none"> 1) Visual Inspection 2) Work Test 	
Spare Parts & Others	<ol style="list-style-type: none"> 1) Dimension Inspection 2) Visual Inspection 	n:5, C=0 n:5, C=0

QUALITY and RELIABILITY

3. In Process Quality Inspection

A. Assembly Lot Acceptance Inspection

(1) Acceptance quality level for wire bond gate inspection

Defect Class	Inspection Level	Type of Defect	
Critical Defect	AQL 0.65%	<ul style="list-style-type: none"> — Missing Metal — Chip Crack — No Probe — Epoxy on Die — Mixed Device — Wrong Bond — Missing Bond 	<ul style="list-style-type: none"> — Diffusion Defect — Ink Die — Exposed Contact — Bond Short — Die Lift — Broken Wire
Major Defect	AQL 1.0%	<ul style="list-style-type: none"> — Metal Missing — Metal Adhesion — Pad Metal Discolored — Tilted Die — Die Orientation — Partial Bond 	<ul style="list-style-type: none"> — Oxide Defect — Probe Damage — Metal Corrosion — Incomplete Wetting — Weakened Wire
Minor Defect	AQL 1.5%	<ul style="list-style-type: none"> — Adjacent Die — Passivation Glass — Die Attach Defect — Wire Loop Height — Extra Wire 	<ul style="list-style-type: none"> — Contamination — Ball Size — Wire Clearance — Bond Deformation

(2) Acceptance quality level for Mold/Trim gate inspection

Defect Class	Inspection Level	Kind of Defect	
Critical Defect	AQL 0.15%	<ul style="list-style-type: none"> — Incomplete Mold — Void, Broken Package — Misalignment 	<ul style="list-style-type: none"> — Deformation — No Plating — Broken Lead
Major Defect	AQL 0.4%	<ul style="list-style-type: none"> — Ejector Pin Defect — Package Burr — Flash on Lead 	<ul style="list-style-type: none"> — Crack, Lead Burr — Rough Surface — Squashed Lead
Minor Defect	AQL 0.65%	<ul style="list-style-type: none"> — Lead Contamination — Poor Plating — Package Contamination 	<ul style="list-style-type: none"> — Bent Lead

B. In-process monitor inspection

Inspection Item	Frequency	Reference
<ul style="list-style-type: none"> • Die Shear Test • Bond Strength Test • Solderability Test • Mark Permanency Test • Lead Integrity Test • In-Process Monitor Inspection for Product • X-Ray Monitor Inspection for Molding • Monitor Inspection for Production Equipment 	<ul style="list-style-type: none"> Each Lot Each Lot Weekly Weekly Weekly 4 Times/Shift/Each Process 2 Times/Shift/Mold Press 2 Times/Shift/Each Unit of Equipment 	<ul style="list-style-type: none"> MIL-STD-883C, 2019-2 MIL-STD-883C, 2011-4 MIL-STD-883C, 2003-3 MIL-STD-883C, 2015-4 MIL-STD-883C, 2004-4 Identify for Each Control Limit Identify for Each Control Limit Identify for Each Control Limit

QUALITY and RELIABILITY

4. Outgoing quality inspection plan (LTPD)

Defect Class	Discrete	LSI	Kind of Defect
Critical Defect electrical visual	1%	2%	Open, short Wrong configuration, no marking
Major Defect electrical visual	1.5%	3%	Items which affect reliability most strongly
Minor Defect electrical visual	2%	5%	Items which minimally or do not affect reliability at all (cosmetic, appearance, etc.)

QUALITY and RELIABILITY











FIGURE 11. General Assembly Flow

Process Flow	Process Step	Major Control Item									
	Wafer										
	Wafer Incoming Inspection	Q.C. Wafer Incoming Inspection AQL 4.0%									
	Tape Mount										
	Sawing Q.C. Monitor	Q.C. Monitoring: — Chip-out — Scratch — Crack — Sawing Discoloration — Sawing-speed — Cut Count — D.I. Purity — CO ₂ Bubble Purity									
	Visual Inspection	100% Screen: — FAB Defect — EDS Test Defect — Sawing & Scratch Defect									
	Q.C. Gate	1st AQL 1.0% Reinspection AQL: 0.65%									
	Lead Frame (L/F)										
	Lead Frame Incoming	*Q.C.L/F Incoming Inspection 1. Acceptance Quality Level — Dimension: LTPD 20%, C=0 — Visual & Mechanical: LTPD 10%, C=2 — Functional Work Test: LTPD 10%, C=2									
	Die Attach (D/A)										
	Q.C. Monitor	*Q.C.D/A Monitor Inspection 1. Bond force 2. Frequency: 4 Times/Station/Shift 3. Sample: 24 ea Time 4. Acceptance Criteria <table border="1" style="margin-left: 20px;"> <thead> <tr> <th>Defect</th> <th>Acceptance</th> <th>Reject</th> </tr> </thead> <tbody> <tr> <td>Critical</td> <td>0</td> <td>1</td> </tr> <tr> <td>Major</td> <td>1</td> <td>2</td> </tr> </tbody> </table>	Defect	Acceptance	Reject	Critical	0	1	Major	1	2
	Defect	Acceptance	Reject								
Critical	0	1									
Major	1	2									
Cure											

2

QUALITY and RELIABILITY

FIGURE 11. General Assembly Flow (Continued)

Process Flow	Process Step	Major Control Item
	Q.C. Monitor	* Q.C. Cure Monitor Inspection 1. Control Item — Temperature — In/out Time 2. Frequency — 1 Time/Shift
	Au Wire	
	Bonding Wire Incoming Inspection	* Q.C. Au Wire Incoming Inspection 1. Visual Inspection: N=5, C=0 2. Bond Pull Test Strength Test: N=13, C=0 3. Bond Ability Test — Critical Defect: AQL 0.65% — Major Defect: AQL 1.0% — Minor Defect: AQL 1.5%
	Wire Bonding (W/B)	
	100% Visual Inspection	
	Q.C. Monitor	* Q.C. W/B Monitor Inspection 1. Frequency: 6 Times/Mach/Shift
	Q.C. Gate	1. Q.C. Acceptance Quality Level — Critical Defect: AQL 0.65% — Major Defect: AQL 1.0% — Minor Defect: AQL 1.5%
	Mold Compound	
	Incoming Inspection Mold	* Moldability Test — Critical Defect: AQL 0.15% — Major Defect: AQL 1.0% — Minor Defect: AQL 1.5%
	Mold	
	Q.C. Monitor	* Q.C. Mold Monitor Inspection 1. In-Process Monitor Inspection — Frequency: 4 Times/Station/Shift — Sample: 200 Units/Time 2. Acceptance Quality Level — Critical Defect: AQL 0.25% — Major Defect: AQL 0.4%

QUALITY and RELIABILITY

FIGURE 11. General Assembly Flow (Continued)

Process Flow	Process Step	Major Control Item
	Cure	
	Q.C. Monitor	* Q.C. Cure Monitor Inspection 1. Control Item — Temperature — In/out Time 2. Frequency — 1 Time/shift
	Deflash	
	Q.C. Monitor	* Q.C. Deflash Monitor Inspection 1. Control Item — Pressure — Belt Speed — Visual/Mechanical Inspection 2. Frequency: 4 Times/Mach/Shift 3. Identify each Defect Control Limit
	TRIM/BEND	
	Q.C. Monitor	* Q.C. Trim/Bend Monitor Inspection 1. Visual Inspection 2. Frequency: 4 times/Station/Shift
	Solder	100% Visual Inspection
	Q.C. Monitor	* Q.C. Solder Monitor Inspection 1. Frequency: 4 Times/Mach/Shift 2. Criteria — Critical Defect: AQL 0.65% — Major Defect: AQL 1.0%
	Q.C. Gate	* Q.C. Mold Gate — Acceptance Criteria Critical Defect: AQL 0.15% Major Defect: AQL 0.4% Minor Defect: AQL 0.65%
	Test	100% Electrical Test
	Q.C. Monitor	Correlation Sample Reading for Initial Device Test
	Mark	100% Visual Inspection

2

QUALITY and RELIABILITY

FIGURE 11. General Assembly Flow (Continued)

Process Flow	Process Step	Major Control Item									
	PRT Monitoring (Process Reliability Testing)	<ol style="list-style-type: none"> PRT for SFET <ul style="list-style-type: none"> HTRB (48 Hrs) HTGB (48 Hrs) other (when applicable) Acceptance Criteria: LTPD 10% 									
	Q.C. Monitor	<ul style="list-style-type: none"> * Q.C. Marking Monitor Inspection <ul style="list-style-type: none"> Frequency: 4 Times/Station/Shift Sample: 24 Units/Time Identify for Each C.L. Acceptance Criteria <table border="1"> <thead> <tr> <th>Defect</th> <th>Acceptance</th> <th>Reject</th> </tr> </thead> <tbody> <tr> <td>Critical</td> <td>0</td> <td>1</td> </tr> <tr> <td>Major</td> <td>1</td> <td>2</td> </tr> </tbody> </table>	Defect	Acceptance	Reject	Critical	0	1	Major	1	2
	Defect	Acceptance	Reject								
	Critical	0	1								
	Major	1	2								
	Q.C. Gate	<ul style="list-style-type: none"> * Q.C. Final Acceptance Level <ul style="list-style-type: none"> Critical Defect: AQL 0.15% Major Defect: AQL 0.4% Minor Defect: AQL 0.65% 									
	Q.A. Gate	<ul style="list-style-type: none"> * Q.A. Incoming inspection for SFET <ol style="list-style-type: none"> Critical Defect: <ul style="list-style-type: none"> Electrical Test: LTPD 2% (N=116, C=0) Visual Test: LTPD 2% (N=116, C=0) Major Defect: <ul style="list-style-type: none"> Electrical Test: LTPD 3% (N=116, C=1) Visual Test: LTPD 3% (N=116, C=1) Minor Defect: <ul style="list-style-type: none"> Electrical Test: LTPD 5% (N=116, C=2) Visual Test: LTPD 5% (N=116, C=2) 									
	Stock	<ul style="list-style-type: none"> * Age Control 									
Q.A. Gate	<ul style="list-style-type: none"> * Q.A. Outgoing Inspection <ol style="list-style-type: none"> Quantity Customer Packing Sampling Inspection (when applicable) <ul style="list-style-type: none"> Sampling plan is same as incoming Inspection 										
Shipment											



PRODUCT GUIDE 3

PRODUCT GUIDE

1. SELECTION GUIDE

N-CHANNEL

BV _{DSS} (V)	I _D (A)	R _{DS(on)} (Ω)	Package	Part Number	Page	
50.00	10.00	0.28	TO-3	SSM10N05	—	
	10.00	0.28	TO-3P	SSH10N05	—	
	10.00	0.28	TO-220	SSP10N05	—	
	12.00	0.20	TO-3	SSM12N05	—	
	12.00	0.20	TO-3P	SSH12N05	—	
	12.00	0.20	TO-220	SSP12N05	—	
60.00	0.40	3.20	TO-126	IRFA1Z3	63	
	3.50	0.80	TO-220	IRF513	228	
	4.00	0.60	TO-220	IRF511	228	
	7.00	0.40	TO-3	IRF123	68	
	7.00	0.40	TO-220	IRF523	233	
	8.00	0.30	TO-3	IRF121	68	
	8.00	0.30	TO-220	IRF521	233	
	10.00	0.28	TO-3	SSM10N06	—	
	10.00	0.28	TO-3P	SSH10N06	—	
	10.00	0.28	TO-220	SSP10N06	—	
	12.00	0.25	TO-3	IRF133	73	
	12.00	0.25	TO-3P	IRFP133	153	
	12.00	0.25	TO-220	IRF533	238	
	12.00	0.20	TO-3	SSM12N06	—	
	12.00	0.20	TO-3P	SSH12N06	—	
	12.00	0.20	TO-220	SSP12N06	—	
	14.00	0.18	TO-3	IRF131	73	
	14.00	0.18	TO-3P	IRFP131	153	
	14.00	0.18	TO-220	IRF531	238	
	24.00	0.11	TO-3	IRF143	78	
	24.00	0.11	TO-3P	IRFP143	158	
	24.00	0.11	TO-220	IRF543	243	
	27.00	0.085	TO-3	IRF141	78	
	27.00	0.085	TO-3P	IRFP141	158	
	27.00	0.085	TO-220	IRF541	243	
	33.00	0.08	TO-3	IRF153	83	
	33.00	0.08	TO-3P	IRFP153	163	
	40.00	0.055	TO-3	IRF151	83	
	40.00	0.055	TO-3P	IRFP151	163	
	80.00	10.00	0.33	TO-3	SSM10N08	—
		10.00	0.33	TO-3P	SSH10N08	—
10.00		0.33	TO-220	SSP10N08	—	
12.00		0.18	TO-3	SSM12N08	—	
12.00		0.18	TO-3P	SSH12N08	—	
12.00		0.18	TO-220	SSP12N08	—	
100.00	0.50	2.40	TO-126	IRFA1Z0	63	
	3.50	0.80	TO-220	IRF512	228	
	4.00	0.60	TO-220	IRF510	228	
	7.00	0.40	TO-3	IRF122	68	
	7.00	0.40	TO-220	IRF522	233	
	8.00	0.30	TO-3	IRF120	68	
	8.00	0.30	TO-220	IRF520	233	
	10.00	0.33	TO-3	SSM10N10	—	
	10.00	0.33	TO-3P	SSH10N10	—	
	10.00	0.33	TO-220	SSP10N10	—	

PRODUCT GUIDE

SELECTION GUIDE (continued)

BV _{DSS} (V)	I _D (A)	R _{DS(on)} (Ω)	Package	Part Number	Page
100.00	12.00	0.18	TO-3	SSM12N10	—
	12.00	0.18	TO-3P	SSH12N10	—
	12.00	0.18	TO-220	SSP12N10	—
	12.00	0.25	TO-3	IRF132	73
	12.00	0.25	TO-3P	IRFP132	153
	12.00	0.25	TO-220	IRF532	238
	14.00	0.18	TO-3	IRF130	73
	14.00	0.18	TO-3P	IRFP130	153
	14.00	0.18	TO-220	IRF530	238
	24.00	0.11	TO-3	IRF142	78
	24.00	0.11	TO-3P	IRFP142	158
	24.00	0.11	TO-220	IRF542	243
	27.00	0.085	TO-3	IRF140	78
	27.00	0.085	TO-3P	IRFP140	158
	27.00	0.085	TO-220	IRF540	243
	33.00	0.08	TO-3	IRF152	83
	33.00	0.08	TO-3P	IRFP152	163
	40.00	0.055	TO-3	IRF150	83
	40.00	0.055	TO-3P	IRFP150	163
	120.00	7.00	0.70	TO-3	SSM7N12
7.00		0.70	TO-3P	SSH7N12	—
7.00		0.70	TO-220	SSP7N12	—
8.00		0.50	TO-3	SSM8N12	—
8.00		0.50	TO-3P	SSH8N12	—
8.00		0.50	TO-220	SSP8N12	—
150.00	2.00	2.40	TO-220	IRF613	248
	2.50	1.50	TO-220	IRF611	248
	4.00	1.20	TO-3	IRF223	88
	4.00	1.20	TO-220	IRF623	253
	5.00	0.80	TO-3	IRF221	88
	5.00	0.80	TO-220	IRF621	253
	7.00	0.70	TO-3	SSM7N15	—
	7.00	0.70	TO-3P	SSH7N15	—
	7.00	0.70	TO-220	SSP7N15	—
	8.00	0.60	TO-3	IRF233	93
	8.00	0.60	TO-3P	IRFP233	173
	8.00	0.60	TO-220	IRF633	258
	8.00	0.50	TO-3	SSM8N15	—
	8.00	0.50	TO-3P	SSH8N15	—
	8.00	0.50	TO-220	SSP8N15	—
	9.00	0.40	TO-3	IRF231	93
	9.00	0.40	TO-3P	IRFP231	173
	9.00	0.40	TO-220	IRF631	258
	16.00	0.22	TO-3	IRF243	98
	16.00	0.22	TO-3P	IRFP243	178
	16.00	0.22	TO-220	IRF643	263
	18.00	0.18	TO-3	IRF241	98
	18.00	0.18	TO-3P	IRFP241	178
	18.00	0.18	TO-220	IRF641	263
	25.00	0.12	TO-3	IRF253	103
	25.00	0.12	TO-3P	IRFP253	183

PRODUCT GUIDE

SELECTION GUIDE (continued)

$BV_{DSS}(V)$	$I_D(A)$	$R_{DS(on)}(\Omega)$	Package	Part Number	Page	
150.00	30.00	0.085	TO-3	IRF251	103	
	30.00	0.085	TO-3P	IRFP251	183	
	40.00	0.05	TO-3	SSM40N15	383	
	40.00	0.05	TO-3P	SSH40N15	383	
180.00	7.00	0.70	TO-3	SSM7N18	—	
	7.00	0.70	TO-3P	SSH7N18	—	
	7.00	0.70	TO-220	SSP7N18	—	
	8.00	0.50	TO-3	SSM8N18	—	
	8.00	0.50	TO-3P	SSH8N18	—	
	8.00	0.50	TO-220	SSP8N18	—	
200.00	2.00	2.40	TO-220	IRF612	248	
	2.50	1.50	TO-220	IRF610	248	
	4.00	1.20	TO-3	IRF222	88	
	4.00	1.20	TO-220	IRF622	253	
	5.00	0.80	TO-3	IRF220	88	
	5.00	0.80	TO-220	IRF620	253	
	7.00	0.70	TO-3	SSM7N20	—	
	7.00	0.70	TO-3P	SSH7N20	—	
	7.00	0.70	TO-220	SSP7N20	—	
	8.00	0.60	TO-3	IRF232	93	
	8.00	0.60	TO-3P	IRFP232	173	
	8.00	0.60	TO-220	IRF632	258	
	8.00	0.50	TO-3	SSM8N20	—	
	8.00	0.50	TO-3P	SSH8N20	—	
	8.00	0.50	TO-220	SSP8N20	—	
	9.00	0.40	TO-3	IRF230	93	
	9.00	0.40	TO-3P	IRFP230	173	
	9.00	0.40	TO-220	IRF630	258	
	16.00	0.22	TO-3	IRF242	98	
	16.00	0.22	TO-3P	IRFP242	178	
	16.00	0.22	TO-220	IRF642	263	
	18.00	0.18	TO-3	IRF240	98	
	18.00	0.18	TO-3P	IRFP240	178	
	18.00	0.18	TO-220	IRF640	263	
	25.00	0.12	TO-3	IRF252	103	
	25.00	0.12	TO-3P	IRFP252	183	
	30.00	0.085	TO-3	IRF250	103	
	30.00	0.085	TO-3P	IRFP250	183	
	40.00	0.05	TO-3P	SSM40N20	383	
	40.00	0.05	TO-3	SSH40N20	383	
	350.00	1.30	5.00	TO-220	IRF713	268
		1.50	3.60	TO-220	IRF711	268
2.50		2.50	TO-3	IRF323	108	
2.50		2.50	TO-220	IRF723	273	
3.00		1.80	TO-3	IRF321	108	
3.00		1.80	TO-220	IRF721	273	
5.00		1.50	TO-3	IRF333	113	
5.00		1.50	TO-3P	IRFP333	193	
5.00		1.50	TO-220	IRF733	278	
5.00		1.00	TO-3	SSM5N35	—	

PRODUCT GUIDE

SELECTION GUIDE (continued)

$BV_{DSS}(V)$	$I_D(A)$	$R_{DS(on)}(\Omega)$	Package	Part Number	Page
350.00	5.00	1.00	TO-3P	SSH5N35	—
	5.00	1.00	TO-220	SSP5N35	—
	5.50	1.00	TO-3	IRF331	113
	5.50	1.00	TO-3P	IRFP331	193
	5.50	1.00	TO-220	IRF731	278
	8.00	0.80	TO-3	IRF343	118
	8.00	0.80	TO-3P	IRFP343	198
	8.00	0.80	TO-220	IRF743	283
	10.00	0.55	TO-3	IRF341	118
	10.00	0.55	TO-3P	IRFP341	198
	10.00	0.55	TO-220	IRF741	283
	13.00	0.40	TO-3	IRF353	123
	13.00	0.40	TO-3P	IRFP353	203
	15.00	0.30	TO-3	IRF351	123
	15.00	0.30	TO-3P	IRFP351	203
	25.00	0.20	TO-3	SSM25N35	392
	25.00	0.20	TO-3P	SSH25N35	392
400.00	1.30	5.00	TO-220	IRF712	268
	1.50	3.60	TO-220	IRF710	268
	2.50	2.50	TO-3	IRF322	108
	2.50	2.50	TO-220	IRF722	273
	3.00	1.80	TO-3	IRF320	108
	3.00	1.80	TO-220	IRF720	273
	5.00	1.50	TO-3	IRF332	113
	5.00	1.50	TO-3P	IRFP332	193
	5.00	1.50	TO-220	IRF732	278
	5.00	1.00	TO-3	SSM5N40	—
	5.00	1.00	TO-3P	SSH5N40	—
	5.00	1.00	TO-220	SSP5N40	—
	5.50	1.00	TO-3	IRF330	113
	5.50	1.00	TO-3P	IRFP330	193
	5.50	1.00	TO-220	IRF730	278
	8.00	0.80	TO-3	IRF342	118
	8.00	0.80	TO-3P	IRFP342	198
	8.00	0.80	TO-220	IRF742	283
	10.00	0.55	TO-3	IRF340	118
	10.00	0.55	TO-3P	IRFP340	198
	10.00	0.55	TO-220	IRF740	283
	13.00	0.40	TO-3	IRF352	123
	13.00	0.40	TO-3P	IRFP352	203
	15.00	0.30	TO-3	IRF350	123
	15.00	0.30	TO-3P	IRFP350	203
	25.00	0.20	TO-3	SSM25N40	392
	25.00	0.20	TO-3P	SSH25N40	392
450.00	2.00	4.00	TO-3	IRF423	128
	2.00	4.00	TO-220	IRF823	288
	2.50	3.00	TO-3	IRF421	128
	2.50	3.00	TO-220	IRF821	288
	4.00	2.00	TO-3	IRF433	133
	4.00	2.00	TO-3P	IRFP433	213
	4.00	2.00	TO-220	IRF833	293

PRODUCT GUIDE

SELECTION GUIDE (continued)

$V_{DSS}(V)$	$I_D(A)$	$R_{DS(on)}(\Omega)$	Package	Part Number	Page	
450.00	4.00	1.50	TO-3	SSM4N45	—	
	4.00	1.50	TO-3P	SSH4N45	—	
	4.00	1.50	TO-220	SSP4N45	—	
	4.50	1.50	TO-3	IRF431	133	
	4.50	1.50	TO-3P	IRFP431	213	
	4.50	1.50	TO-220	IRF831	293	
	7.00	1.10	TO-3	IRF443	138	
	7.00	1.10	TO-3P	IRFP443	218	
	7.00	1.10	TO-220	IRF843	298	
	8.00	0.85	TO-3	IRF441	138	
	8.00	0.85	TO-3P	IRFP441	218	
	8.00	0.85	TO-220	IRF841	298	
	12.00	0.50	TO-3	IRF453	143	
	12.00	0.50	TO-3P	IRFP453	223	
	13.00	0.40	TO-3	IRF451	143	
	13.00	0.40	TO-3P	IRFP451	223	
	20.00	0.30	TO-3	SSM20N45	386	
	20.00	0.30	TO-3P	SSH20N45	386	
	500.00	2.00	4.00	TO-3	IRF422	128
		2.00	4.00	TO-220	IRF822	288
2.50		3.00	TO-3	IRF420	128	
2.50		3.00	TO-220	IRF820	288	
4.00		2.00	TO-3	IRF432	133	
4.00		2.00	TO-3P	IRFP432	213	
4.00		2.00	TO-220	IRF832	293	
4.00		1.50	TO-3	SSM4N50	—	
4.00		1.50	TO-3P	SSH4N50	—	
4.00		1.50	TO-220	SSP4N50	—	
4.50		1.50	TO-3	IRF430	133	
4.50		1.50	TO-3P	IRFP430	213	
4.50		1.50	TO-220	IRF830	293	
7.00		1.10	TO-3	IRF442	138	
7.00		1.10	TO-3P	IRFP442	218	
7.00		1.10	TO-220	IRF842	298	
8.00		0.85	TO-3	IRF440	138	
8.00		0.85	TO-3P	IRFP440	218	
8.00		0.85	TO-220	IRF840	298	
12.00		0.50	TO-3	IRF452	143	
12.00		0.50	TO-3P	IRFP452	223	
13.00		0.40	TO-3	IRF450	143	
13.00		0.40	TO-3P	IRFP450	223	
20.00		0.30	TO-3	SSM20N50	386	
20.00		0.30	TO-3P	SSH20N50	386	
550.00		4.00	3.00	TO-3	SSM4N55	308
		4.00	3.00	TO-3P	SSH4N55	338
		4.00	3.00	TO-220	SSP4N55	368
	6.00	1.80	TO-3	SSM6N55	318	
	6.00	1.80	TO-3P	SSH6N55	348	
	6.00	1.80	TO-220	SSP6N55	378	
	8.00	1.00	TO-3	SSM8N55	328	
	8.00	1.00	TO-3P	SSH8N55	358	



3

PRODUCT GUIDE

SELECTION GUIDE (continued)

BV _{DSS} (V)	I _D (A)	R _{DSON} (Ω)	Package	Part Number	Page
550.00	15.00	0.50	TO-3	SSM15N55	389
	15.00	0.50	TO-3P	SSH15N55	389
600.00	4.00	3.00	TO-3	SSM4N60	308
	4.00	3.00	TO-3P	SSH4N60	338
	4.00	3.00	TO-220	SSP4N60	368
	6.00	1.80	TO-3	SSM6N60	318
	6.00	1.80	TO-3P	SSH6N60	348
	6.00	1.80	TO-220	SSP6N60	378
	8.00	1.00	TO-3	SSM8N60	328
	8.00	1.00	TO-3P	SSH8N60	358
	15.00	0.50	TO-3	SSM15N60	389
	15.00	0.50	TO-3P	SSH15N60	389
700.00	3.00	6.00	TO-3	SSM3N70	303
	3.00	6.00	TO-3P	SSH3N70	333
	3.00	6.00	TO-220	SSP3N70	363
	4.00	3.30	TO-3	SSM4N70	313
	4.00	3.30	TO-3P	SSH4N70	343
	4.00	3.30	TO-220	SSP4N70	373
	6.00	1.90	TO-3	SSM6N70	323
	6.00	1.90	TO-3P	SSH6N70	353
	10.00	0.80	TO-3	SSM10N70	395
	10.00	0.80	TO-220	SSH10N70	395

P-CHANNEL

BV _{DSS} (V)	I _D (A)	R _{DSON} (Ω)	Package	Part Number	Page
-60.00	-2.50	1.60	TO-220	IRF9513	398
	-3.00	1.20	TO-220	IRF9511	398
	-5.00	0.80	TO-220	IRF9523	401
	-6.00	0.60	TO-220	IRF9521	401
	-10.00	0.40	TO-3	IRF9133	404
	-10.00	0.40	TO-3P	IRFP9133	404
	-10.00	0.40	TO-220	IRF9533	404
	-12.00	0.30	TO-3	IRF9131	404
	-12.00	0.30	TO-3P	IRFP9131	404
	-12.00	0.30	TO-220	IRF9531	404
	-15.00	0.30	TO-3	IRF9143	407
	-15.00	0.30	TO-3P	IRFP9143	407
	-15.00	0.30	TO-220	IRF9543	407
	-19.00	0.20	TO-3	IRF9141	407
	-19.00	0.20	TO-3P	IRFP9141	407
	-19.00	0.20	TO-220	IRF9541	407
-100.00	-2.50	1.60	TO-220	IRF9512	398
	-3.00	1.20	TO-220	IRF9510	398
	-5.00	0.80	TO-220	IRF9522	401
	-6.00	0.60	TO-220	IRF9520	401

PRODUCT GUIDE

P-CHANNEL (continued)

BV _{DSS} (V)	I _D (A)	R _{DS(on)} (Ω)	Package	Part Number	Page	
-100.00	-10.00	0.40	TO-3	IRF9132	404	
	-10.00	0.40	TO-3P	IRFP9132	404	
	-10.00	0.40	TO-220	IRF9632	416	
	-12.00	0.30	TO-3	IRF9130	404	
	-12.00	0.30	TO-3P	IRFP9130	404	
	-12.00	0.30	TO-220	IRF9630	416	
	-15.00	0.30	TO-3	IRF9142	407	
	-15.00	0.30	TO-3P	IRFP9142	407	
	-15.00	0.30	TO-220	IRF9542	407	
	-19.00	0.20	TO-3	IRF9140	407	
	-19.00	0.20	TO-3P	IRFP9140	407	
	-19.00	0.20	TO-220	IRF9540	407	
	-150.00	-1.50	4.50	TO-220	IRF9613	410
		-1.75	3.00	TO-220	IRF9611	410
-3.00		2.40	TO-220	IRF9623	413	
-3.50		1.50	TO-220	IRF9621	413	
-5.50		1.20	TO-3	IRF9233	416	
-5.50		1.20	TO-3P	IRFP9233	416	
-5.50		1.20	TO-220	IRF9633	416	
-6.50		0.80	TO-3	IRF9231	416	
-6.50		0.80	TO-3P	IRFP9231	416	
-6.50		0.80	TO-220	IRF9631	416	
-9.00		0.70	TO-3	IRF9243	419	
-9.00		0.70	TO-3P	IRFP9243	419	
-9.00		0.70	TO-220	IRF9643	419	
-11.00		0.50	TO-3	IRF9241	419	
-11.00		0.50	TO-3P	IRFP9241	419	
-11.00		0.50	TO-220	IRF9641	419	
-250.00		-1.50	4.50	TO-220	IRF9612	410
		-1.75	3.00	TO-220	IRF9610	410
	-3.00	2.40	TO-220	IRF9622	413	
	-3.50	1.50	TO-220	IRF9620	413	
	-5.50	1.20	TO-3	IRF9232	416	
	-5.50	1.20	TO-3P	IRFP9232	416	
	-5.50	1.20	TO-220	IRF9632	416	
	-6.50	0.80	TO-3	IRF9230	416	
	-6.50	0.80	TO-3P	IRFP9230	416	
	-6.50	0.80	TO-220	IRF9630	416	
	-9.00	0.70	TO-3	IRF9242	419	
	-9.00	0.70	TO-3P	IRFP9242	419	
	-9.00	0.70	TO-220	IRF9642	419	
	-11.00	0.50	TO-3	IRF9240	419	
	-11.00	0.50	TO-3P	IRFP9240	419	
	-11.00	0.50	TO-220	IRF9640	419	

PRODUCT GUIDE

2. ALPHA NUMERIC INDEX

Part Number	Page Number	Part Number	Page Number	Part Number	Page Number
IRF120	68	IRF422	128	IRFP322	188
IRF121	68	IRF423	128	IRFP323	188
IRF122	68	IRF430	133	IRFP330	193
IRF123	68	IRF431	133	IRFP331	193
IRF130	73	IRF432	133	IRFP332	193
IRF131	73	IRF433	133	IRFP333	193
IRF132	73	IRF440	138	IRFP340	198
IRF133	73	IRF441	138	IRFP341	198
IRF140	78	IRF442	138	IRFP342	198
IRF141	78	IRF443	138	IRFP343	198
IRF142	78	IRF450	143	IRFP350	203
IRF143	78	IRF451	143	IRFP351	203
IRF150	83	IRF452	143	IRFP352	203
IRF151	83	IRF453	143	IRFP353	203
IRF152	83	IRFA1Z0	63	IRF420	208
IRF153	83	IRFA1Z3	63	IRF421	208
IRF220	88	IRFP120	148	IRF422	208
IRF221	88	IRFP121	148	IRF423	208
IRF222	88	IRFP122	148	IRFP430	213
IRF223	88	IRFP123	148	IRFP431	213
IRF230	93	IRFP130	153	IRFP432	213
IRF231	93	IRFP131	153	IRFP433	213
IRF232	93	IRFP132	153	IRFP440	218
IRF233	93	IRFP133	153	IRFP441	218
IRF240	98	IRFP140	158	IRFP442	218
IRF241	98	IRFP141	158	IRFP443	218
IRF242	98	IRFP142	158	IRFP450	223
IRF243	98	IRFP143	158	IRFP451	223
IRF250	103	IRFP150	163	IRFP452	223
IRF251	103	IRFP151	163	IRFP453	223
IRF252	103	IRFP152	163	IRF510	228
IRF253	103	IRFP153	163	IRF511	228
IRF320	108	IRFP220	168	IRF512	228
IRF321	108	IRFP221	168	IRF513	228
IRF322	108	IRFP222	168	IRF520	233
IRF323	108	IRFP223	168	IRF521	233
IRF330	113	IRFP230	173	IRF522	233
IRF331	113	IRFP231	173	IRF523	233
IRF332	113	IRFP232	173	IRF530	238
IRF333	113	IRFP233	173	IRF531	238
IRF340	118	IRFP240	178	IRF532	238
IRF341	118	IRFP241	178	IRF533	238
IRF342	118	IRFP242	178	IRF540	243
IRF343	118	IRFP243	178	IRF541	243
IRF350	123	IRFP250	183	IRF542	243
IRF351	123	IRFP251	183	IRF543	243
IRF352	123	IRFP252	183	IRF610	248
IRF353	123	IRFP253	183	IRF611	248
IRF420	128	IRFP320	188	IRF612	248
IRF421	128	IRFP321	188	IRF613	248

PRODUCT GUIDE

ALPHA NUMERIC INDEX (continued)

Part Number	Page Number	Part Number	Page Number	Part Number	Page Number
IRF620	253	SSM6N55	318	SSH8N60	358
IRF621	253	SSM6N60	318	SSH10N05	—
IRF622	253	SSM6N70	323	SSH10N06	—
IRF623	253	SSM7N12	—	SSH10N08	—
IRF630	258	SSM7N15	—	SSH10N10	—
IRF631	258	SSM7N18	—	SSH10N70	395
IRF632	258	SSM7N20	—	SSH12N05	—
IRF633	258	SSM8N12	—	SSH12N06	—
IRF640	263	SSM8N15	—	SSH12N08	—
IRF641	263	SSM8N18	—	SSH12N10	—
IRF642	263	SSM8N20	—	SSH15N55	389
IRF643	263	SSM8N55	328	SSH15N60	389
IRF710	268	SSM8N60	328	SSH20N45	386
IRF711	268	SSM10N05	—	SSH20N50	386
IRF712	268	SSM10N06	—	SSH25N35	392
IRF713	268	SSM10N08	—	SSH25N40	392
IRF720	273	SSM10N10	—	SSP3N70	363
IRF721	273	SSM10N70	395	SSP4N45	—
IRF722	273	SSM12N05	—	SSP4N50	—
IRF723	273	SSM12N06	—	SSP4N55	368
IRF730	278	SSM12N08	—	SSP4N60	368
IRF731	278	SSM12N10	—	SSP4N70	373
IRF732	278	SSM15N55	389	SSP5N35	—
IRF733	278	SSM15N60	389	SSP5N40	—
IRF740	283	SSM20N45	386	SSP6N55	378
IRF741	283	SSM20N50	386	SSP6N60	378
IRF742	283	SSM25N35	392	SSP7N12	—
IRF743	283	SSM25N40	392	SSP7N15	—
IRF820	288	SSH3N70	333	SSP7N18	—
IRF821	288	SSH4N45	—	SSP7N20	—
IRF822	288	SSH4N50	—	SSP8N12	—
IRF823	288	SSH4N55	338	SSP8N15	—
IRF830	293	SSH4N60	338	SSP8N18	—
IRF831	293	SSH4N70	343	SSP8N20	—
IRF832	293	SSH40N15	283	SSP10N05	—
IRF833	293	SSH40N20	283	SSP10N06	—
IRF840	298	SSH5N35	—	SSP10N08	—
IRF841	298	SSH5N40	—	SSP10N10	—
IRF842	298	SSH6N55	348	SSP12N05	—
IRF843	298	SSH6N60	348	SSP12N06	—
SSM3N70	303	SSH6N70	353	SSP12N08	—
SSM4N45	—	SSH7N12	—	SSP12N10	—
SSM4N50	—	SSH7N15	—	IRF9120	401
SSM4N55	308	SSH7N18	—	IRF9121	401
SSM4N60	308	SSH7N20	—	IRF9122	401
SSM4N70	313	SSH8N12	—	IRF9123	401
SSM40N15	383	SSH8N15	—	IRF9130	404
SSM40N20	383	SSH8N18	—	IRF9131	404
SSM5N35	—	SSH8N20	—	IRF9132	404
SSM5N40	—	SSH8N55	358	IRF9133	404

PRODUCT GUIDE

ALPHA NUMERIC INDEX (continued)

Part Number	Page Number	Part Number	Page Number	Part Number	Page Number
IRF9140	407	IRFP9140	407	IRF9530	404
IRF9141	407	IRFP9141	407	IRF9531	404
IRF9142	407	IRFP9142	407	IRF9532	404
IRF9143	407	IRFP9143	407	IRF9533	404
IRF9220	413	IRFP9220	413	IRF9540	407
IRF9221	413	IRFP9221	413	IRF9541	407
IRF9222	413	IRFP9222	413	IRF9542	407
IRF9223	413	IRFP9223	413	IRF9543	407
IRF9230	416	IRFP9230	416	IRF9610	410
IRF9231	416	IRFP9231	416	IRF9611	410
IRF9232	416	IRFP9232	416	IRF9612	410
IRF9233	416	IRFP9233	416	IRF9613	410
IRF9240	419	IRFP9240	419	IRF9620	413
IRF9241	419	IRFP9241	419	IRF9621	413
IRF9242	419	IRFP9242	419	IRF9622	413
IRF9243	419	IRFP9243	419	IRF9623	413
IRFP9120	401	IRF9510	398	IRF9630	416
IRFP9121	401	IRF9511	398	IRF9631	416
IRFP9122	401	IRF9512	398	IRF9632	416
IRFP9123	401	IRF9513	398	IRF9633	416
IRFP9130	404	IRF9520	401	IRF9640	416
IRFP9131	404	IRF9521	401	IRF9641	416
IRFP9132	404	IRF9522	401	IRF9642	416
IRFP9133	404	IRF9523	410	IRF9643	416

PRODUCT GUIDE

3. CROSS REFERENCE GUIDE

The following table represents a cross reference for POWER MOSFETS.

The Samsung devices are a replacement for the indicated industry part numbers.

Inter-national Rectifier	SAMSUNG Direct Replacement	Inter-national Rectifier	SAMSUNG Direct Replacement	Inter-national Rectifier	SAMSUNG Direct Replacement	Inter-national Rectifier	SAMSUNG Direct Replacement
IRF120	IRF120	IRF352	IRF352	IRF713	IRF713	IRF9620	IRF9620
IRF121	IRF121	IRF353	IRF353	IRF720	IRF720	IRF9621	IRF9621
IRF122	IRF122	IRF420	IRF420	IRF721	IRF721	IRF9622	IRF9622
IRF123	IRF123	IRF421	IRF421	IRF722	IRF722	IRF9623	IRF9623
IRF130	IRF130	IRF422	IRF422	IRF723	IRF723	IRF9630	IRF9630
IRF131	IRF131	IRF423	IRF423	IRF730	IRF730	IRF9631	IRF9631
IRF132	IRF132	IRF430	IRF430	IRF731	IRF731	IRF9632	IRF9632
IRF133	IRF133	IRF431	IRF431	IRF732	IRF732	IRF9633	IRF9633
IRF140	IRF140	IRF432	IRF432	IRF733	IRF733	IRF9640	IRF9640
IRF141	IRF141	IRF433	IRF433	IRF740	IRF740	IRF9641	IRF9641
IRF142	IRF142	IRF440	IRF440	IRF741	IRF741	IRF9642	IRF9642
IRF143	IRF143	IRF441	IRF441	IRF742	IRF742	IRF9643	IRF9643
IRF150	IRF150	IRF442	IRF442	IRF743	IRF743	IRFD1Z0	(IRFA1Z0)
IRF151	IRF151	IRF443	IRF443	IRF820	IRF820	IRFD1Z3	(IRFA1Z3)
IRF152	IRF152	IRF450	IRF450	IRF821	IRF821		
IRF153	IRF153	IRF451	IRF451	IRF822	IRF822	IRFP131	IRFP131
IRF220	IRF220	IRF452	IRF452	IRF823	IRF823	IRFP132	IRFP132
IRF221	IRF221	IRF453	IRF453	IRF830	IRF830	IRFP133	IRFP133
IRF222	IRF222	IRF510	IRF510	IRF831	IRF831	IRFP140	IRFP140
IRF223	IRF223	IRF511	IRF511	IRF832	IRF832	IRFP141	IRFP141
IRF231	IRF231	IRF512	IRF512	IRF833	IRF833	IRFP142	IRFP142
IRF232	IRF232	IRF513	IRF513	IRF840	IRF840	IRFP143	IRFP143
IRF233	IRF233	IRF520	IRF520	IRF841	IRF841	IRFP150	IRFP150
IRF240	IRF240	IRF521	IRF521	IRF842	IRF842	IRFP151	IRFP151
IRF241	IRF241	IRF522	IRF522	IRF843	IRF843	IRFP152	IRFP152
IRF242	IRF242	IRF523	IRF523	IRF9510	IRF9510	IRFP153	IRFP153
IRF243	IRF243	IRF610	IRF610	IRF9511	IRF9511	IRFP230	IRFP230
IRF250	IRF250	IRF611	IRF611	IRF9512	IRF9512	IRFP231	IRFP231
IRF251	IRF251	IRF612	IRF612	IRF9513	IRF9513	IRFP232	IRFP232
IRF252	IRF252	IRF613	IRF613	IRF9520	IRF9520	IRFP233	IRFP233
IRF253	IRF253	IRF620	IRF620	IRF9521	IRF9521	IRFP240	IRFP240
IRF320	IRF320	IRF621	IRF621	IRF9522	IRF9522	IRFP241	IRFP241
IRF321	IRF321	IRF622	IRF622	IRF9523	IRF9523	IRFP242	IRFP242
IRF322	IRF322	IRF623	IRF623	IRF9530	IRF9530	IRFP243	IRFP243
IRF323	IRF323	IRF630	IRF630	IRF9531	IRF9531	IRFP250	IRFP250
IRF330	IRF330	IRF631	IRF631	IRF9532	IRF9532	IRFP251	IRFP251
IRF331	IRF331	IRF632	IRF632	IRF9533	IRF9533	IRFP252	IRFP252
IRF332	IRF332	IRF633	IRF633	IRF9540	IRF9540	IRFP253	IRFP253
IRF333	IRF333	IRF640	IRF640	IRF9541	IRF9541	IRFP330	IRFP330
IRF340	IRF340	IRF641	IRF641	IRF9542	IRF9542	IRFP331	IRFP331
IRF341	IRF341	IRF642	IRF642	IRF9543	IRF9543	IRFP332	IRFP332
IRF342	IRF342	IRF643	IRF643	IRF9610	IRF9610	IRFP333	IRFP333
IRF343	IRF343	IRF710	IRF710	IRF9611	IRF9611	IRFP340	IRFP340
IRF350	IRF350	IRF711	IRF711	IRF9612	IRF9612	IRFP341	IRFP341
IRF351	IRF351	IRF712	IRF712	IRF9613	IRF9613	IRFP342	IRFP342

() Samsung number in Parentheses : Package alter native on possible substitution

PRODUCT GUIDE

CROSS REFERENCES GUIDE (continued)

International Rectifier	SAMSUNG Direct Replacement	International Rectifier	SAMSUNG Direct Replacement	International Rectifier	SAMSUNG Direct Replacement	International Rectifier	SAMSUNG Direct Replacement
IRFP343	IRFP343	IRFP441	IRFP441	IRFP9133	IRFP9133	IRFP9241	IRFP9241
IRFP350	IRFP350	IRFP442	IRFP442	IRFP9140	IRFP9140	IRFP9242	IRFP9242
IRFP351	IRFP351	IRFP443	IRFP443	IRFP9141	IRFP9141	IRFP9243	IRFP9243
IRFP352	IRFP352	IRFP450	IRFP450	IRFP9142	IRFP9142		
IRFP353	IRFP353	IRFP451	IRFP451	IRFP9143	IRFP9143		
IRFP430	IRFP430	IRFP452	IRFP452	IRFP9230	IRFP9230		
IRFP431	IRFP431	IRFP453	IRFP453	IRFP9231	IRFP9231		
IRFP432	IRFP432	IRFP9130	IRFP9130	IRFP9232	IRFP9232		
IRFP433	IRFP433	IRFP9131	IRFP9131	IRFP9233	IRFP9233		
IRFP440	IRFP440	IRFP9132	IRFP9132	IRFP9240	IRFP9240		

MOTOROLA	SAMSUNG Direct Replacement	MOTOROLA	SAMSUNG Direct Replacement	MOTOROLA	SAMSUNG Direct Replacement	MOTOROLA	SAMSUNG Direct Replacement
MTH6N55	SSH6N55	MTM7N12	IRF233	MTM12N20	IRF242	MTP2N35	IRF723
MTH6N60	SSH6N60	MTM7N15	IRF233	MTM15N05	IRF143	MTP2N40	IRF722
MTH8N55	SSH8N55	MTM1N18	IRF232	MTM15N06	IRF143	MTP2N45	IRF823
MTH8N60	SSH8N60	MTM7N20	IRF232	MTM15N12	IRF243	MTP2N50	IRF822
MTH7N35	IRFP343	MTM7N45	IRF441	MTM15N15	IRF243	MTP2N55	
MTH7N40	IRFP342	MTM7N50	IRF442	MTM15N18	IRF242	MTP2N60	
MTH8N35	IRFP343	MTM8N08	IRF120	MTM15N20	IRF242	MTP3N12	IRF623
MTH8N40	IRFP342	MTM8N10	IRF120	MTM15N35	IRF351	MTP3N15	IRF623
MTH15N18	IRFP242	MTM8N12	IRF233	MTM15N40	IRF350	MTP3N18	IRF622
MTH15N20	IRFP242	MTM8N15	IRF233	MTM15N45	SSM20N45	MTP3N20	IRF620
MTH20N12	IRFP253	MTM8N18	IRF232	MTM15N50	SSM20N50	MTP3N35	IRF721
MTH20N15	IRFP253	MTM8N20	IRF232	MTM20N08	IRF142	MTP3N40	IRF720
MTH25N08	IRFP140	MTM8N35	IRF343	MTM20N10	IRF142	MTP3N55	SSP4N55
MTH25N10	IRFP140	MTM8N40	IRF342	MTM20N12	IRF253	MTP3N60	SSP4N60
MTH35N05	IRFP151	MTM8P08	IRF9132	MTM20N15	IRF253	MTP4N08	IRF510
MTH35N06	IRFP151	MTM8P10	IRF9132	MTM25N05	IRF141	MTP4N10	IRF510
MTM2N45	IRF421	MTM10N05	IRF133	MTM25N06	IRF141	MTP4N12	IRF623
MTM2N50	IRF422	MTM10N06	IRF133	MTM25N08	IRF140	MTP4N15	IRF623
MTM3N35	IRF321	MTM10N08	IRF132	MTM25N10	IRF140	MTP4N45	IRF833
MTM3N40	IRF320	MTM10N10	IRF132	MTM35N05	IRF151	MTP4N50	IRF832
MTM3N55	SSM4N55	MTM10N12	IRF243	MTM35N06	IRF151	MTP5N05	IRF523
MTM3N60	SSM4N60	MTM10N15	IRF243	MTM40N18	SSM40N20	MTP5N06	IRF523
MTM4N45	IRF433	MTM10N25	IRF353	MTM40N20	SSM40N20	MTP5N18	IRF620
MTM4N50	IRF432	MTM12N05	IRF133	MTP1N45	IRF823	MTP5N20	IRF620
MTM5N18	IRF220	MTM12N06	IRF133	MTP1N50	IRF822	MTP5N35	IRF731
MTM5N20	IRF220	MTM12N08	IRF132	MTP1N55		MTP5N40	IRF730
MTM5N35	IRF333	MTM12N10	IRF132	MTP1N60		MTP7N12	IRF633
MTM5N40	IRF330	MTM12N12	IRF243	MTP2N18	IRF612	MTP7N15	IRF633
MTM6N55	SSM6N55	MTM12N15	IRF243	MTP2N20	IRF612	MTP7N18	IRF632
MTM6N60	SSM6N60	MTM12N18	IRF242	MTP2N25	IRF723	MTP7N20	IRF632



PRODUCT GUIDE

CROSS REFERENCES GUIDE (continued)

MOTOROLA	SAMSUNG Direct Replacement	MOTOROLA	SAMSUNG Direct Replacement	MOTOROLA	SAMSUNG Direct Replacement	MOTOROLA	SAMSUNG Direct Replacement
MTP8N08	IRF520	MTP10N05	IRF533	MTP12N06	IRF533	MTP15N15	IRF643
MTP8N10	IRF520	MTP10N06	IRF533	MTP12N08	IRF532	MTP20N08	IRF542
MTP8N12	IRF633	MTP10N08	IRF532	MTP12N10	IRF532	MTP20N20	IRF542
MTP8N15	IRF633	MTP10N10	IRF532	MTP12N18	IRF642	MTP25N05	IRF541
MTP8N18	IRF632	MTP10N12	IRF643	MTP12N20	IRF642	MTP25N06	IRF541
MTP8N20	IRF632	MTP10N15	IRF643	MTP15N05	IRF543		
MTP8P08	IRF9532	MTP10N25	IRF743	MTP15N06	IRF543		
MTP8P10	IRF9532	MTP12N05	IRF533	MTP15N12	IRF643		

Siliconix	SAMSUNG Direct Replacement	Siliconix	SAMSUNG Direct Replacement	Siliconix	SAMSUNG Direct Replacement	Siliconix	SAMSUNG Direct Replacement
VN30AA	IRF123	VN0109N5	IRF512	VN0300D	IRF513	VN0801D	IRF532
VN33AJ	IRF123	VN0110N1	IRF122	VN0330N1	IRF323	VN1000A	IRF130
VN35AA	IRF123	VN0110N5	IRF512	VN0330N5	IRF723	VN1000D	IRF530
VN35AJ	IRF123	VN0114N1	IRF223	VN0335N1	IRF323	VN1001A	IRF132
VN40AD	IRF513	VN0114N5	IRF613	VN0335N5	IRF723	VN1001D	IRF532
VN46AD	IRF513	VN0116N1	IRF222	VN0340N1	IRF322	VN1102N1	IRF123
VN64AG	IRF123	VN0116N5	IRF612	VN0340N5	IRF722	VN1102N5	IRF523
VN66AD	IRF513	VN0120N1	IRF222	VN0345A1	IRF441	VN1103N1	IRF123
VN66AJ	IRF123	VN0120N5	IRF612	VN0345N1	IRF421	VN1103N5	IRF523
VN67AA	IRF123	VN0202N1	IRF123	VN0345N5	IRF821	VN1104N1	IRF123
VN67AD	IRF513	VN0202N5	IRF513	VN0350A1	IRF440	VN1104N5	IRF523
VN67AJ	IRF123	VN0203N1	IRF123	VN0350N1	IRF422	VN1106N1	IRF123
VN88AD	IRF512	VN0203N5	IRF513	VN0355N1	SSM4N55	VN1106N5	IRF523
VN89AA	IRF122	VN0204N1	IRF123	VN0360N1	SSM4N60	VN1109N1	IRF122
VN89AD	IRF512	VN0204N5	IRF513	VN0400A	IRF143	VN1109N5	IRF522
VN90AA	IRF122	VN0206N1	IRF123	VN0400D	IRF543	VN1110N1	IRF122
VN98AJ	IRF122	VN0206N5	IRF513	VN0401A	IRF143	VN1110N5	IRF522
VN99AA	IRF122	VN0208N1	IRF122	VN0401D	IRF543	VN1114N1	IRF223
VN99AJ	IRF122	VN0208N5	IRF512	VN0430N1	IRF341	VN1114N5	IRF611
VN0102N1	IRF123	VN0209N1	IRF122	VN0435N1	IRF341	VN1115N1	IRF223
VN0102N5	IRF513	VN0209N5	IRF512	VN0440N1	IRF340	VN1115N5	IRF611
VN0103N1	IRF123	VN0210N1	IRF122	VN0445N1	IRF453	VN1116N1	IRF222
VN0103N5	IRF513	VN0210N5	IRF512	VN0450N1	IRF440	VN1116N5	IRF612
VN0104N1	IRF123	VN0214N1	IRF223	VN0600A	IRF143	VN1120N1	IRF222
VN0104N5	IRF513	VN0214N5	IRF613	VN0600D	IRF543	VN1120N5	IRF612
VN0106N1	IRF123	VN0215N5	IRF613	VN0601A	IRF143	VN1200A	IRF241
VN0106N5	IRF513	VN0216N1	IRF222	VN0601D	IRF543	VN1200D	IRF641
VN0108N1	IRF122	VN0216N5	IRF612	VN0800A	IRF130	VN1201A	IRF243
VN0108N5	IRF512	VN0220N1	IRF222	VN0800D	IRF530	VN1201D	IRF643
VN0109N1	IRF122	VN0220N5	IRF612	VN0801A	IRF132	VN1202N1	IRF133

3

PRODUCT GUIDE

CROSS REFERENCES GUIDE (continued)

Siliconix	SAMSUNG Direct Replacement	Siliconix	SAMSUNG Direct Replacement	Siliconix	SAMSUNG Direct Replacement	Siliconix	SAMSUNG Direct Replacement
VN1202N5	IRF533	VN2406D	IRF713	VP0109N5	IRF9512	VP1109N1	IRF9132
VN1203N1	IRF133	VN3500A	IRF331	VP0110N5	IRF9512	VP1109N5	IRF9512
VN1203N5	IRF533	VN3500D	IRF731	VP0114N5	IRF9613	VP1110N1	IRF9132
VN1204N1	IRF123	VN3501A	IRF333	VP0202N1	IRF9133	VP1110N5	IRF9512
VN1204N5	IRF523	VN3501D	IRF733	VP0202N5	IRF9513	VP1114N1	IRF9233
VN1206D	IRF613	VN3502A	IRF321	VP0203N1	IRF9133	VP1114N5	IRF9611
VN1206N1	IRF123	VN4000A	IRF330	VP0203N5	IRF9513	VP1115N1	IRF9233
VN1206N5	IRF523	VN4000D	IRF730	VP0204N1	IRF9133	VP1115N5	IRF9611
VN1208N1	IRF122	VN4001A	IRF332	VP0204N5	IRF9513	VP1116N1	IRF9232
VN1208N5	IRF522	VN4001D	IRF732	VP0206N1	IRF9133	VP1116N5	IRF9612
VN1209N1	IRF122	VN4002A	IRF320	VP0206N5	IRF9513	VP1120N1	IRF9232
VN1209N5	IRF522	VN4501A	IRF431	VP0208N1	IRF9132	VP1120N5	IRF9612
VN1210N1	IRF122	VN4501D	IRF831	VP0208N5	IRF9512	VP1202N1	IRF9133
VN1210N5	IRF522	VN4502A	IRF433	VP0209N1	IRF9132	VP1202N5	IRF9533
VN1215N1	IRF233	VN4502D	IRF833	VP0209N5	IRF9512	VP1203N1	IRF9133
VN1215N5	IRF633	VN5001A	IRF430	VP0210N1	IRF9132	VP1203N5	IRF9533
VN1216N1	IRF222	VN5001D	IRF830	VP0210N5	IRF9512	VP1204N1	IRF9133
VN1216N5	IRF610	VN5002A	IRF432	VP0214N1	IRF9233	VP1204N5	IRF9523
VN1220N1	IRF222	VN5002D	IRF832	VP0214N5	IRF9613	VP1206N1	IRF9133
VN1220N5	IRF610	VN5001A	IRF331	VP0215N5	IRF9613	VP1206N5	IRF9523
VN1706D	IRF612	VNM001A	IRF330	VP0216N1	IRF9232	VP1208N1	IRF9132
VN2306N1	IRF141	VNM002A	IRF431	VP0216N5	IRF9612	VP1208N5	IRF9522
VN2306N5	IRF541	VNP002A	IRF430	VP0220N1	IRF9232	VP1209N1	IRF9132
VN2310N1	IRF140	VNS008A	SSM6N60	VP0220N5	IRF9612	VP1209N5	IRF9522
VN2310N5	IRF540	VNS008D	SSP6N60	VP0335N1	(IRF9232)	VP1210N1	IRF9132
VN2315N1	IRF241	VNS009A	SSM5N60	VP0335N5	(IRF9612)	VP1210N5	IRF9522
VN2315N5	IRF641	VNS009D	SSP5N60	VP0340N1	(IRF9232)	VP1215N1	IRF9233
VN2320N1	IRF242	VNT008A	SSM6N70	VP0340N5	(IRF9612)	VP1215N5	IRF9621
VN2320N5	IRF642	VNT008D	SSP6N70	VP0345N1	(IRF9232)	VP1216N1	IRF9232
VN2330N1	IRF341	VNT009A	SSM6N70	VP0345N5	(IRF9612)	VP1216N5	IRF9610
VN2330N5	IRF741	VNT009D	SSP6N70	VP1102N1	IRF9133	VP1220N1	IRF9232
VN2335N1	IRF341	VP0102N5	IRF9513	VP1102N5	IRF9523	VP1220N5	IRF9610
VN2335N5	IRF741	VP0103N5	IRF9513	VP1103N1	IRF9133	ZVN0102L	IRF513
VN2340N1	IRF340	VP0104N5	IRF9513	VP1103N5	IRF9523	ZNV0106L	IRF513
VN2340N5	IRF740	VP0106N5	IRF9513	VP1104N1	IRF9133	ZNV0108L	IRF512
VN2345N1	IRF453	VP0108N1	IRF9132	VP1104N5	IRF9513		
VN2350N1	IRF442	VP0108N5	IRF9512	VP1106N1	IRF9133		
VN2350N5	IRF842	VP0109N1	IRF9132	VP1106N5	IRF9513		

() Samsung number in parentheses : Package alter native on possible substitution

PRODUCT GUIDE

CROSS REFERENCES GUIDE (continued)

GE	SAMSUNG Direct Replacement	GE	SAMSUNG Direct Replacement	GE	SAMSUNG Direct Replacement	GE	SAMSUNG Direct Replacement
D84BK1 D84BK2 D84BK4 D84BL1 D84BL2	IRF523 IRF523 IRF511 IRF510 IRF510	D84DL2 D84DL3 D84DL4 D84DM1 D84DM2	IRF530 IRF532 IRF532 IRF631 IRF631	D84CL2 D86CL4 D86CM2 D86CM4 D86CN2	IRF120 IRF122 IRF221 IRF221 IRF220	D86EK4 D86EL4 D86EM1 D86EM2 D86EM4	IRF151 IRF142 IRF253 IRF253 IRF241
D84BL3 D84BL4 D84BM1 D84BM2 D84BM3	IRF512 IRF512 IRF611 IRF611 IRF611	D84DM4 D84DN1 D84DN2 D84DN3 D84DN4	IRF631 IRF630 IRF630 IRF632 IRF632	D86CN3 D86CN4 D86CQ1 D86CQ2 D86CQ3	IRF222 IRF222 IRF321 IRF320 IRF323	D86EN2 D86EN3 D86EN4 D86EQ1 D86EQ2	IRF240 IRF242 IRF242 IRF341 IRF340
D84BM4 D84BN1 D84BN2 D84BN3 D84BN4	IRF613 IRF610 IRF610 IRF612 IRF612	D84DQ1 D84DQ2 D84DQ3 D84DQ4 D84DR1	IRF731 IRF730 IRF733 IRF732 IRF831	D86CQ4 D86CR1 D86CR2 D86CR3 D86CR4	IRF322 IRF421 IRF420 IRF423 IRF422	D86EQ3 D86EQ4 D86ER1 D86ER2 D86ER3	IRF343 IRF342 IRF441 IRF440 IRF443
D84BQ1 D84BQ2 D84BQ3 D84BQ4 D84CK3	IRF711 IRF710 IRF713 IRF712 IRF521	D84DR2 D84DR3 D84DR4 D84DS1 D84DS2	IRF830 IRF833 IRF832 (IRF832) (IRF832)	D86DK1 D86DK2 D86DK3 D86DK4 D86DL1	IRF131 IRF131 IRF133 IRF133 IRF130	D86ER4 D86ES1 D86ES2 D86EU2 D86EV1	IRF442 (IRF430) (IRF430) (IRF420) (IRF422)
D84CK4 D84CL2 D84CL4 D84CM2 D84CM4	IRF521 IRF520 IRF522 IRF621 IRF623	D84EL2 D84EL4 D84EM2 D84EM4 D84EN2	IRF540 IRF542 IRF641 IRF643 IRF640	D86DL2 D86DL3 D86DL4 D86DM1 D86DM2	IRF130 IRF132 IRF132 IRF231 IRF231	D86EV2 D86EW1 D86EW2 D86FL2 D86FL4	(IRF422) (IRF422) (IRF422) IRF150 IRF152
D84CN1 D84CN2 D84CN3 D84CN4 D84CQ1	IRF620 IRF620 IRF622 IRF622 IRF721	D84EN4 D84EQ1 D84EQ2 D84EQ3 D84DQ4	IRF642 IRF741 IRF740 IRF743 IRF742	D86DM3 D86DM4 D86DN1 D86DN2 D86DN3	IRF231 IRF231 IRF230 IRF230 IRF230	D86FM2 D86FN2 D86FN4 D86FQ1 D86FQ2	IRF251 IRF250 IRF252 IRF351 IRF350
D84CQ2 D84CQ3 D84CQ4 D84CR1 D84CR2	IRF720 IRF723 IRF722 IRF821 IRF820	D84ER1 D84ER2 D84ER3 D84ER4 D84EU2	IRF841 IRF840 IRF843 IRF842 (IRF820)	D86DN4 D86DQ1 D86DQ2 D86DQ3 D86DQ4	IRF230 IRF331 IRF330 IRF333 IRF332	D86FQ3 D86FQ4 D86FR1 D86FR2 D86FR3	IRF353 IRF352 IRF451 IRF450 IRF453
D84CR3 D84CR4 D84DK1 D84DK2 D83DK3	IRF823 IRF822 IRF531 IRF531 IRF533	D84EV1 D84EV2 D84EW1 D84EW2 D86CK2	(IRF822) (IRF822) (IRF822) (IRF822) IRF131	D86DR1 D86DR2 D86DR3 D86DR4 D86DS1	IRF431 IRF430 IRF433 IRF432 IRF432	D86FR4 D86FU2	IRF452 (IRF432)
D84DK4 D84DL1	IRF533 IRF530	D86CK3 D84CK4	IRF121 IRF121	D86DS2 D86EK3	(IRF432) (IRF432)		

() Samsung number in parentheses : Package alter native on possible substitution

PRODUCT GUIDE

CROSS REFERENCES GUIDE (continued)

RCA	SAMSUNG Direct Replacement	RCA	SAMSUNG Direct Replacement	RCA	SAMSUNG Direct Replacement	RCA	SAMSUNG Direct Replacement
RCA9192A RCA9192B RCA9195A RCA9195B RCA9212A	IRF120 IRF243 IRF142 IRF253 IRF520	RFM3N45 RFM3N50 RFM4N35 RFM4N40 RFM5P12	IRF421 IRF420 IRF321 IRF320 IRF9231	RFM15N12 RFM15N15 RFM18N08 RFM18N10 RFM25N05	IRF253 IRF253 IRF142 IRF142 IRF141	RFP5P12 RFP5P15 RFP6P08 RFP6P10 RFP7N45	IRF9631 IRF9631 IRF9520 IRF9520 IRF831
RCA9212B RCA9213A RCA9213B RCA9230A	IRF643 IRF512 IRF613 IRF542	RFM5P15 RFM6P08 RFM6P10 RFM7N45 RFM7N50	IRF9231 IRF9132 IRF9232 IRF431 IRF430	RFM25N06 RFP1N35 RFP1N40 RFP2N08 RFP2N10	IRF141 IRF713 IRF712 IRF512 IRF512	RFP7N50 RFP8N18 RFP8N20 RFP8N08 RFP8N10	IRF830 IRF630 IRF630 IRF9532 IRF9532
RFK15N35 RFK15N40 RFK15N45 RFK15N50 RFK20P08	IRF353 IRF352 IRF441 IRF440 IRF9140	RFM8N18 RFM8N20 RFM8P08 RFM8P10 RFM10N12	IRF230 IRF230 IRF9132 IRF9132 IRF243	RFP2N12 RFP2N15 RFP2N18 RFP2N20 RFP2P08	IRF611 IRF611 IRF612 IRF612 IRF9512	RFP10N12 RFP10N15 RFP10P12 RFP12N08 RFP12N10	IRF643 IRF643 (IRF9532) IRF530 IRF530
RFK20P10 RFK25N18 RFK25N20 RFK30N12 RFK30N15	IRF9140 IRF252 IRF252 IRF251 IRF251	RFM10N15 RFM10P12 RFM10P15 RFM12N18 RFM12N20	IRF243 IRF9241 IRF9241 IRF242 IRF242	RFP2P10 RFP3N45 RFP3N50 RFP4N05 RFP4N06	IRF9512 IRF821 IRF820 IRF513 IRF513	RFP12N20 RFP15N05 RFP15N06 RFP15N12 RFP18N10	IRF642 IRF543 IRF543 (IRF643) IRF542
RFK35N08 RFK35N10	IRF150 IRF150	RFM15N05 RFM15N06	IRF143 IRF143	RFP4N35 RFP4N40	IRF721 IRF720	RFP25N05	IRF541

Siemens	SAMSUNG Direct Replacement	Siemens	SAMSUNG Direct Replacement	Siemens	SAMSUNG Direct Replacement	Siemens	SAMSUNG Direct Replacement
BUZ10 BUZ10A BUZ10B BUZ11A BUZ14A	IRF541 IRF543 IRF533 IRF543 IRF151	BUZ25 BUZ27 BUZ28 BUZ31 BUZ32	IRF140 IRFP140 IRFP141 IRF640 IRF630	BUZ41A BUZ41B BUZ42 BUZ42A BUZ42B	IRF830 IRF831 IRF832 IRF833 IRF820	BUZ60B BUZ60C BUZ60D BUZ63 BUZ63A	IRF732 IRF733 IRF720 IRF330 IRF331
BUZ14B BUZ17 BUZ18 BUZ20 BUZ20A	IRF153 IRF153 IRF151 IRF530 IRF532	BUZ32A BUZ32B BUZ32C BUZ34 BUZ35	IRF631 IRF632 IRF633 IRF240 IRF230	BUZ42C BUZ44 BUZ44A BUZ44B BUZ45	IRF821 IRF422 IRF430 IRF431 IRF452	BUZ63B BUZ63C BUZ63D BUZ64 BUZ64A	IRF332 IRF333 IRF320 IRF352 IRF353
BUZ20B BUZ201 BUZ21 BUZ211 BUZ23	IRF520 IRF353 IRF540 IRF452 IRF130	BUZ35A BUZ351 BUZ353 BUZ354 BUZ36	IRF231 IRFP353 IRFP453 IRFP453 IRF252	BUZ45A BUZ45B BUZ45C BUZ46 BUZ46A	IRF452 IRF452 IRF453 IRF432 IRF433	BUZ67 BUZ71 BUZ71A BUZ72A BUZ73A	IRFP340 IRF541 IRF543 IRF532 IRF632
BUZ23A BUZ23B BUZ24 BUZ24A BUZ24B	IRF130 IRF120 IRF150 IRF150 IRF152	BUZ237 BUZ38 BUZ382 BUZ385 BUZ41	IRFP242 IRFP240 IRFP353 IRFP440 IRF840	BUZ46B BUZ48 BUZ48A BUZ60 BUZ60A	IRF420 IRFP450 IRFP452 IRF730 IRF730	BUZ74 BUZ74A BUZ76 BUZ76A	IRF820 IRF822 IRF720 IRF722

() Samsung number in Parentheses : Package alter native on possible substitution

DATA SHEETS 4



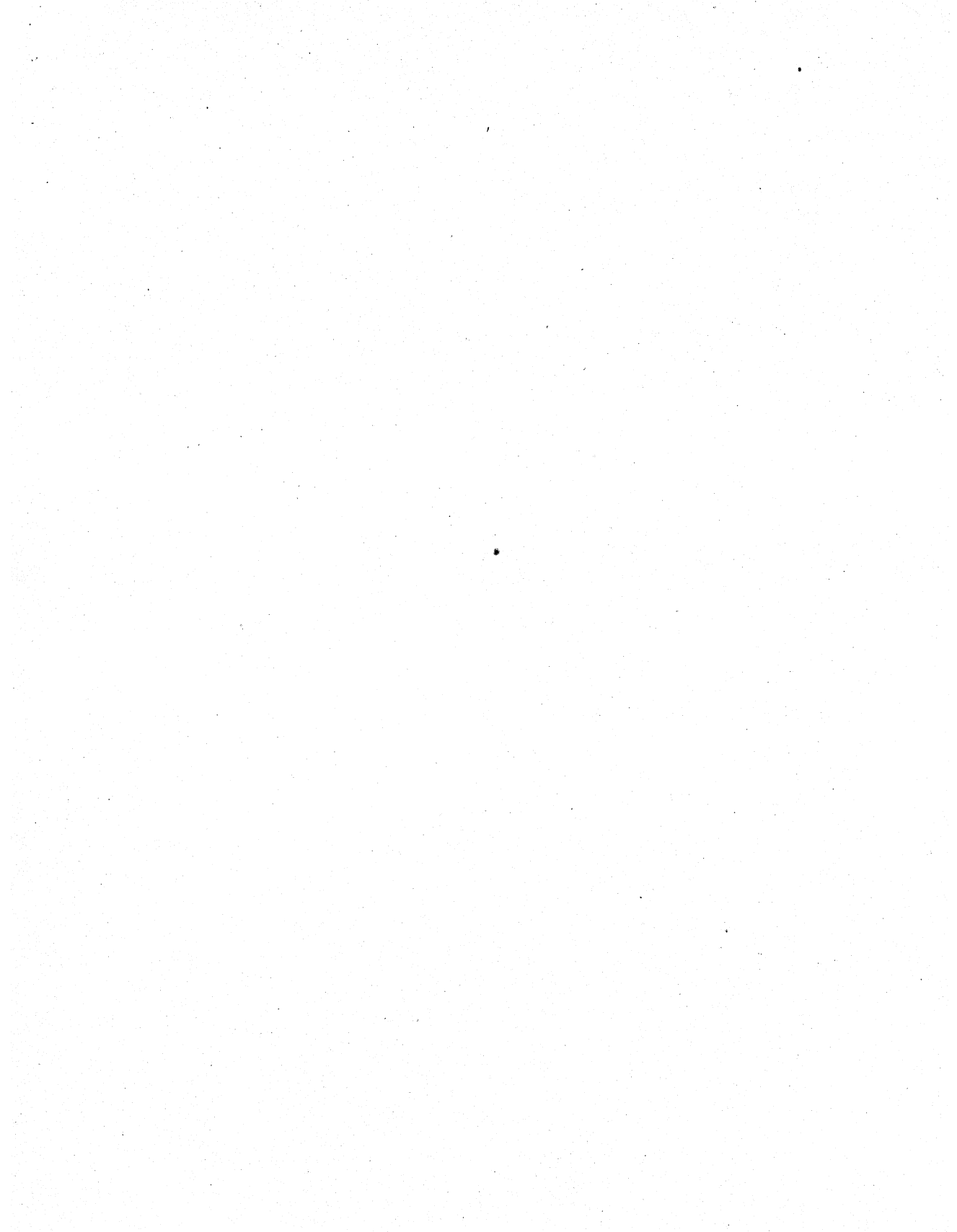

FEATURES

- Low $R_{DS(on)}$
- Improved inductive ruggedness
- Fast switching times
- Rugged polysilicon gate cell structure
- Low input capacitance
- Extended safe operating area
- Improved high temperature reliability
- TO-126 package

PRODUCT SUMMARY

Part Number	V_{DS}	$R_{DS(on)}$	I_D
IRFA1Z0	100V	2.4 Ω	0.5A
IRFA1Z3	60V	3.2 Ω	0.4A

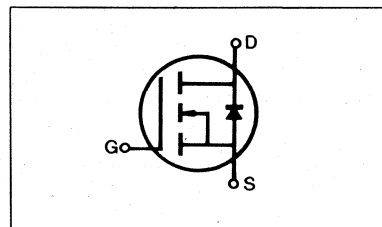
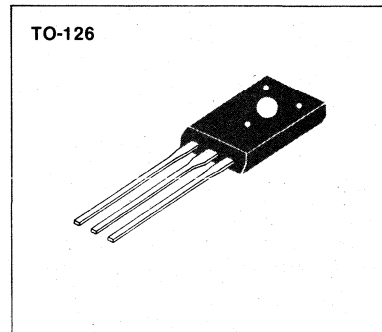

MAXIMUM RATINGS

Characteristic	Symbol	IRFA1Z0	IRFA1Z3	Unit
Drain-Source Voltage (1)	V_{DSS}	100	60	Vdc
Drain-Gate Voltage ($R_{GS}=1.0M\Omega$)(1)	V_{DGR}	100	60	Vdc
Gate-Source Voltage	V_{GS}	± 20		Vdc
Continuous Drain Current $T_C=25^\circ C$	I_D	0.5	0.4	Adc
Continuous Drain Current $T_C=100^\circ C$	I_D	0.3	0.25	Adc
Drain Current—Pulsed (3)	I_{DM}	4.0	3.2	Adc
Total Power Dissipation @ $T_C=25^\circ C$ Derate above $25^\circ C$.	P_D	1.0 0.008		Watts W/ $^\circ C$
Operating and Storage Junction Temperature Range	T_J, T_{stg}	-55 to 150		$^\circ C$
Maximum Lead Temp. for Soldering Purposes, 1/8" from case for 5 seconds	T_L	300		$^\circ C$

- NOTES:** (1) $T_J=25^\circ C$ to $150^\circ C$
 (2) Pulse test: Pulse width $\leq 300\mu s$, Duty Cycle $\leq 2\%$
 (3) Repetitive rating: Pulse width limited by max. junction temperature

ELECTRICAL CHARACTERISTICS (T_C=25°C unless otherwise specified)

Characteristic	Symbol	Type	Min	Typ	Max	Units	Test Conditions
Drain-Source Breakdown Voltage	BV _{DSS}	IRFA1Z0	100	—	—	V	V _{GS} =0V
		IRFA1Z3	60	—	—	V	I _D =250μA
Gate Threshold Voltage	V _{GS(th)}	ALL	2.0	—	4.0	V	V _{DS} =V _{GS} , I _D =250μA
Gate-Source Leakage Forward	I _{GSS}	ALL	—	—	100	nA	V _{GS} =20V
Gate-Source Leakage Reverse	I _{GSS}	ALL	—	—	-100	nA	V _{GS} =-20V
Zero Gate Voltage Drain Current	I _{DSS}	ALL	—	—	250	μA	V _{DS} =Max. Rating, V _{GS} =0V
			—	—	1000	μA	V _{DS} =Max. Rating×0.8, V _{GS} =0V, T _C =125°C
On-State Drain-Source Current (2)	I _{D(on)}	IRFA1Z0	0.5	—	—	A	V _{DS} >I _{D(on)} ×R _{DS(on)} max, V _{GS} =10V
		IRFA1Z3	0.4	—	—	A	
Static Drain-Source On-State Resistance (2)	R _{DS(on)}	IRFA1Z0	—	1.5	2.4	Ω	V _{GS} =10V, I _D =0.25A
		IRFA1Z3	—	2	3.2	Ω	
Forward Transconductance (2)	g _{fs}	ALL	0.25	0.35	—	Ω	V _{DS} >I _{D(on)} ×R _{DS(on)} max, I _D =0.25A
Input Capacitance	C _{iss}	ALL	—	65	70	pF	V _{GS} =0V, V _{DS} =25V, f=1.0MHz
Output Capacitance	C _{oss}	ALL	—	24	30	pF	
Reverse Transfer Capacitance	C _{rss}	ALL	—	9	100	pF	
Turn-On Delay Time	t _{d(on)}	ALL	—	10	20	ns	V _{DD} =0.5BV _{DSS} , I _D =0.25A, Z _O =50Ω (MOSFET switching times are essentially independent of operating temperature.)
Rise Time	t _r	ALL	15	25	ns		
Turn-Off Delay Time	t _{d(off)}	ALL	—	15	25	ns	
Fall Time	t _f	ALL	—	10	20	ns	
Total Gate Charge (Gate-Source Plus Gate-Drain)	Q _g	ALL	—	2.0	3.0	nC	V _{GS} =10V, I _D =1.2A, V _{DS} =0.8 Max. Rating (Gate charge is essentially independent of operating temperature.)
Gate-Source Charge	Q _{gs}	ALL	—	0.6	—	nC	
Gate-Drain ("Miller") Charge	Q _{gd}	ALL	—	1.4	—	nC	

THERMAL RESISTANCE

Junction-to-Ambient	R _{thJC}	ALL	—	—	120	K/W	Free Air Operation
---------------------	-------------------	-----	---	---	-----	-----	--------------------

SOURCE-DRAIN DIODE RATINGS AND CHARACTERISTICS

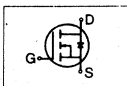
Characteristic	Symbol	Type	Min	Typ	Max	Units	Test Conditions
Continuous Source Current (Body Diode)	I _S	IRFA1Z0	—	—	0.5	A	Modified MOSFET symbol showing the integral reverse P-N junction rectifier
		IRFA1Z3	—	—	0.4	A	
Pulse Source Current (Body Diode) (3)	I _{SM}	IRFA1Z0	—	—	4.0	A	
		IRFA1Z3	—	—	3.2	A	
Diode Forward Voltage (2)	V _{SD}	IRFA1Z0	—	—	1.4	V	T _C =25°C, I _S =0.5A, V _{GS} =0V
		IRFA1Z3	—	—	1.3	V	T _C =25°C, I _S =0.4A, V _{GS} =0V
Reverse Recovery Time	t _{rr}	ALL	—	100	—	ns	T _J =150°C, I _F =0.5A, di _F /dt=100A/μs

- Notes:** (1) T_J=25°C to 150°C
 (2) Pulse test: Pulse width≤300μs, Duty Cycle≤2%
 (3) Repetitive rating: Pulse width limited by max. junction temperature

IRFA1Z0/1Z3

N-CHANNEL POWER MOSFETS

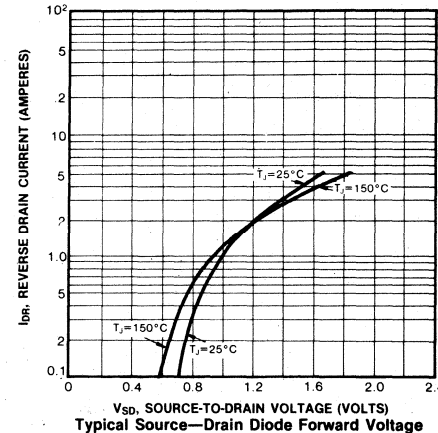
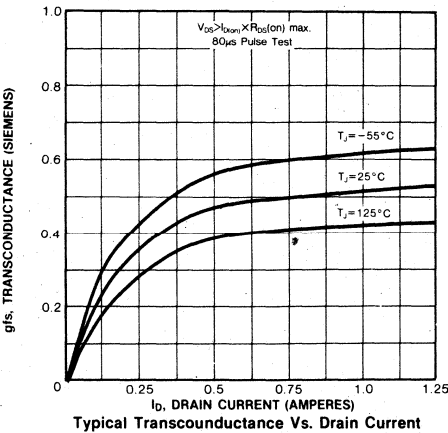
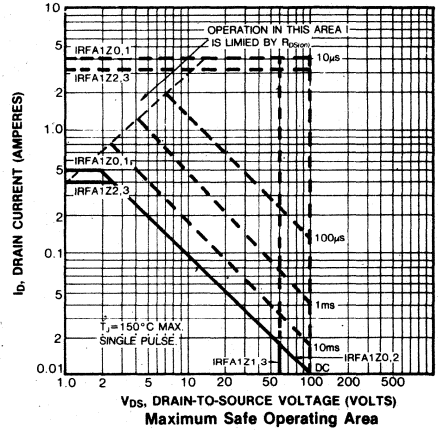
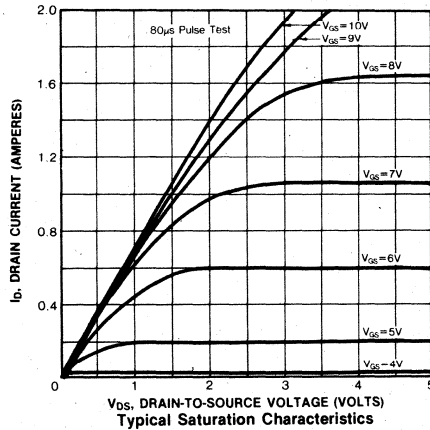
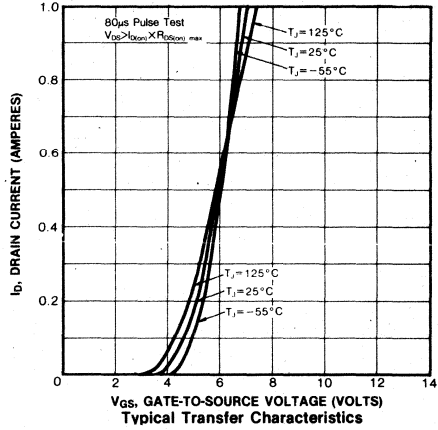
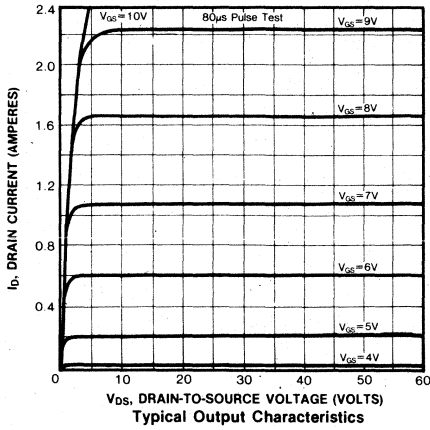

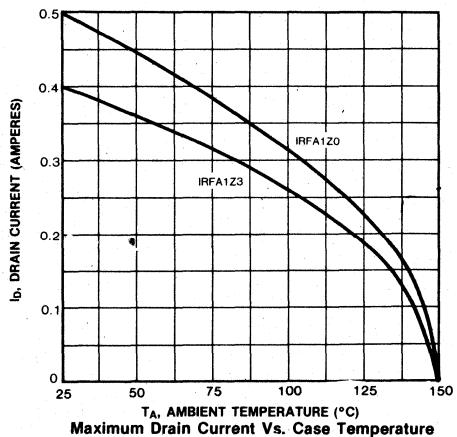
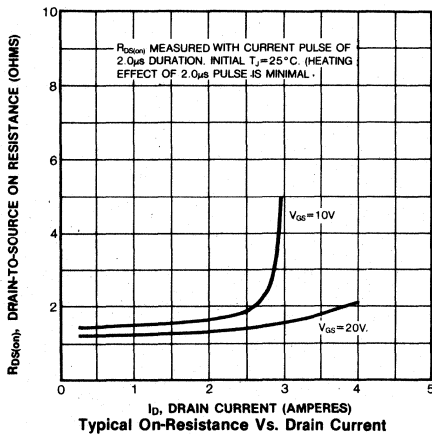
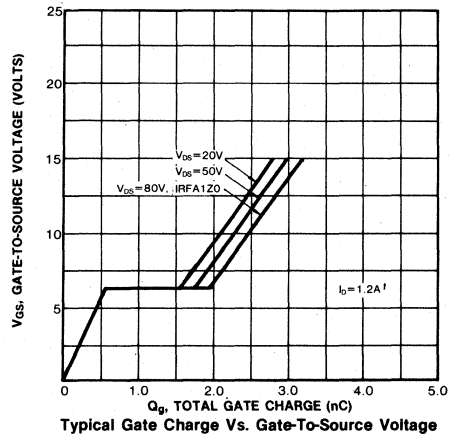
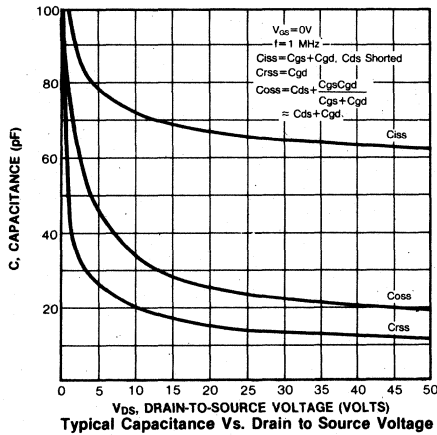
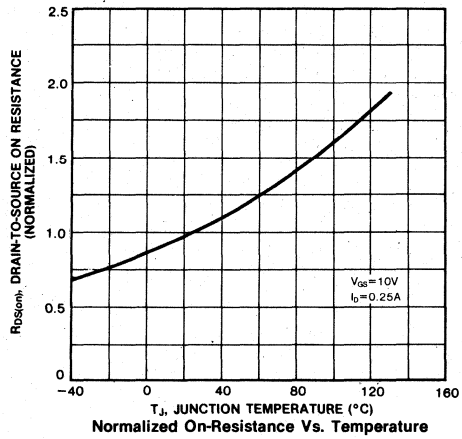
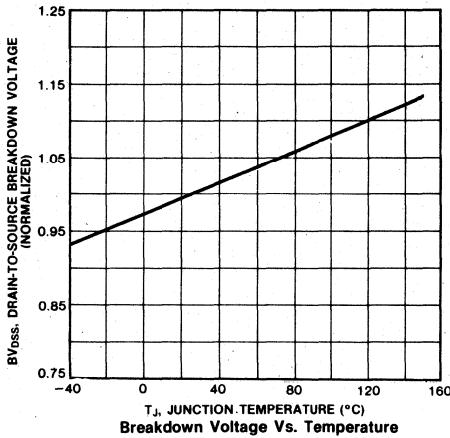

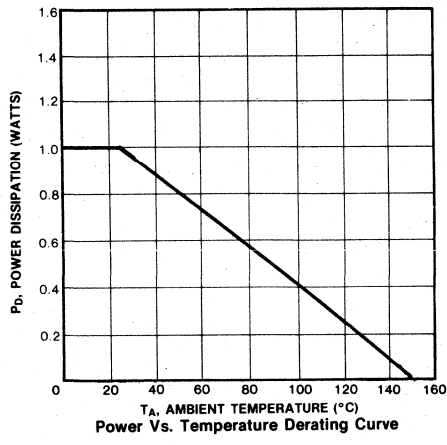

Power Vs. Temperature Derating Curve

4

FEATURES

- Low $R_{DS(on)}$
- Improved inductive ruggedness
- Fast switching times
- Rugged polysilicon gate cell structure
- Low input capacitance
- Extended safe operating area
- Improved high temperature reliability
- TO-3 package (Standard)

PRODUCT SUMMARY

Part Number	V_{DS}	$R_{DS(on)}$	I_D
IRF120	100V	0.30 Ω	8.0A
IRF121	60V	0.30 Ω	8.0A
IRF122	100V	0.40 Ω	7.0A
IRF123	60V	0.40 Ω	7.0A

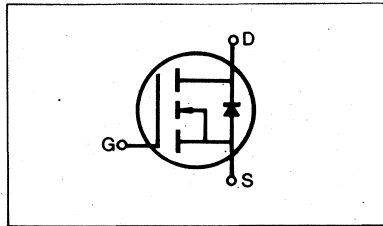
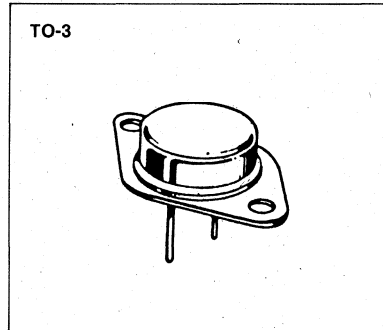

MAXIMUM RATINGS

Characteristic	Symbol	IRF120	IRF121	IRF122	IRF123	Unit
Drain-Source Voltage (1)	V_{DSS}	100	60	100	60	Vdc
Drain-Gate Voltage ($R_{GS}=1.0M\Omega$)(1)	V_{DGR}	100	60	100	60	Vdc
Gate-Source Voltage	V_{GS}	± 20				Vdc
Continuous Drain Current $T_C=25^\circ C$	I_D	8.0	8.0	7.0	7.0	Adc
Continuous Drain Current $T_C=100^\circ C$	I_D	5.0	5.0	4.0	4.0	Adc
Drain Current—Pulsed (3)	I_{DM}	32	32	28	28	Adc
Gate Current—Pulsed	I_{GM}	± 1.5				Adc
Total Power Dissipation @ $T_C=25^\circ C$ Derate above $25^\circ C$	P_D	40 0.32				Watts W/ $^\circ C$
Operating and Storage Junction Temperature Range	T_J, T_{stg}	-55 to 150				$^\circ C$
Maximum Lead Temp. for Soldering Purposes, 1/8" from case for 5 seconds	T_L	300				$^\circ C$

- Notes:** (1) $T_J=25^\circ C$ to $150^\circ C$
 (2) Pulse test: Pulse width $\leq 300\mu s$, Duty Cycle $\leq 2\%$
 (3) Repetitive rating: Pulse width limited by max. junction temperature

ELECTRICAL CHARACTERISTICS (T_C=25°C unless otherwise specified)

Characteristic	Symbol	Type	Min	Typ	Max	Units	Test Conditions
Drain-Source Breakdown Voltage	BV _{DSS}	IRF120 IRF122	100	—	—	V	V _{GS} =0V
		IRF121 IRF123	60	—	—	V	I _D =250μA
Gate Threshold Voltage	V _{GS(th)}	ALL	2.0	—	4.0	V	V _{DS} =V _{GS} , I _D =250μA
Gate-Source Leakage Forward	I _{GSS}	ALL	—	—	100	nA	V _{GS} =20V
Gate-Source Leakage Reverse	I _{GSS}	ALL	—	—	-100	nA	V _{GS} =-20V
Zero Gate Voltage Drain Current	I _{DSS}	ALL	—	—	250	μA	V _{DS} =Max. Rating, V _{GS} =0V
			—	—	1000	μA	V _{DS} =Max. Rating×0.8, V _{GS} =0V, T _C =125°C
On-State Drain-Source Current (2)	I _{D(on)}	IRF120 IRF121	8.0	—	—	A	V _{DS} >I _{D(on)} ×R _{DS(on) max.} , V _{GS} =10V
		IRF122 IRF123	7.0	—	—	A	
Static Drain-Source On-State Resistance (2)	R _{DS(on)}	IRF120 IRF121	—	0.23	0.30	Ω	V _{GS} =10V, I _D =4.0A
		IRF122 IRF123	—	0.30	0.40	Ω	
Forward Transconductance (2)	g _{fs}	ALL	1.5	3.1	—	∅	V _{DS} >I _{D(on)} ×R _{DS(on) max.} , I _D =4.0A
Input Capacitance	C _{iss}	ALL	—	460	600	pF	V _{GS} =0V, V _{DS} =25V, f=1.0MHz
Output Capacitance	C _{oss}	ALL	—	220	400	pF	
Reverse Transfer Capacitance	C _{rss}	ALL	—	70	100	pF	
Turn-On Delay Time	t _{d(on)}	ALL	—	—	40	ns	V _{DD} =0.5BV _{DSS} , I _D =4.0A, Z _O =50Ω (MOSFET switching times are essentially independent of operating temperature.)
Rise Time	t _r	ALL	—	—	70	ns	
Turn-Off Delay Time	t _{d(off)}	ALL	—	—	100	ns	
Fall Time	t _f	ALL	—	—	70	ns	
Total Gate Charge (Gate-Source Plus Gate-Drain)	Q _g	ALL	—	9.8	15	nC	V _{GS} =10V, I _D =10A, V _{DS} =0.8 Max. Rating (Gate charge is essentially independent of operating temperature.)
Gate-Source Charge	Q _{gs}	ALL	—	3.5	—	nC	
Gate-Drain ("Miller") Charge	Q _{gd}	ALL	—	6.3	—	nC	

THERMAL RESISTANCE

Junction-to-Case	R _{thJC}	ALL	—	—	3.12	K/W	
Case-to-Sink	R _{thCS}	ALL	—	0.1	—	K/W	Mounting surface flat, smooth, and greased
Junction-to-Ambient	R _{thJA}	ALL	—	—	30	K/W	Free Air Operation

- Notes:** (1) T_J=25°C to 150°C
 (2) Pulse test: Pulse width≤300μs, Duty Cycle≤2%
 (3) Repetitive rating: Pulse width limited by max. junction temperature

SOURCE-DRAIN DIODE RATINGS AND CHARACTERISTICS

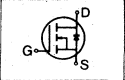
Characteristic	Symbol	Type	Min	Typ	Max	Units	Test Conditions
Continuous Source Current (Body Diode)	I _S	IRF120	—	—	8.0	A	Modified MOSFET symbol showing the integral reverse P-N junction rectifier 
		IRF121	—	—	8.0	A	
		IRF122	—	—	7.0	A	
		IRF123	—	—	7.0	A	
Pulse Source Current (Body Diode) (3)	I _{SM}	IRF120	—	—	32	A	
		IRF121	—	—	32	A	
		IRF122	—	—	28	A	
		IRF123	—	—	28	A	
Diode Forward Voltage (2)	V _{SD}	IRF120	—	—	2.5	V	T _C =25°C, I _S =8.0A, V _{GS} =0V
		IRF121	—	—	2.5	V	T _C =25°C, I _S =8.0A, V _{GS} =0V
		IRF122	—	—	2.3	V	T _C =25°C, I _S =7.0A, V _{GS} =0V
		IRF123	—	—	2.3	V	T _C =25°C, I _S =7.0A, V _{GS} =0V
Reverse Recovery Time	t _{rr}	ALL	—	280	—	ns	T _J =150°C, I _F =8.0A, dI _F /dt=100A/μs

Notes: (1) T_J=25°C to 150°C (2) Pulse test: Pulse width ≤ 300μs, Duty Cycle ≤ 2%
(3) Repetitive rating: Pulse width limited by max. junction temperature

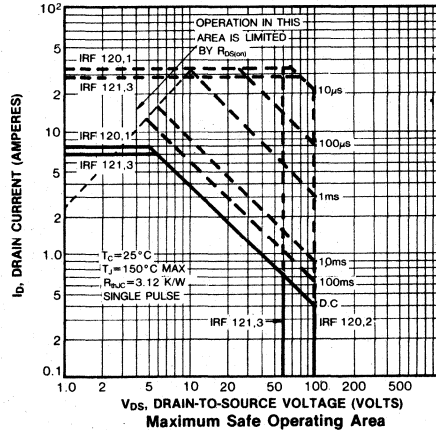
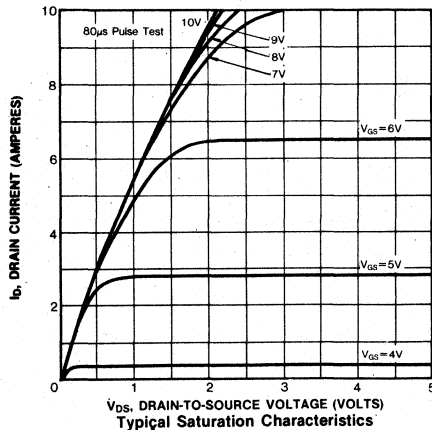
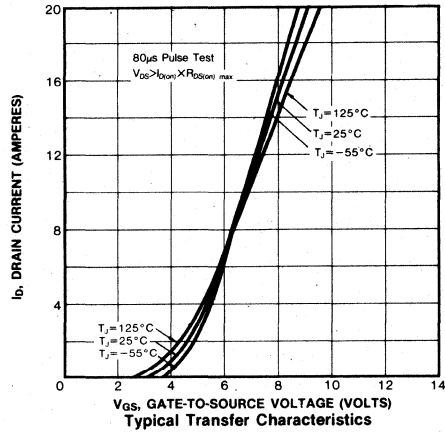
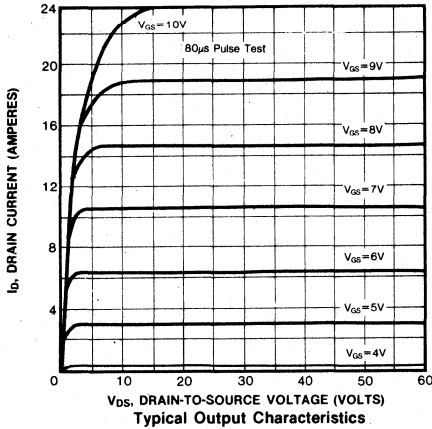

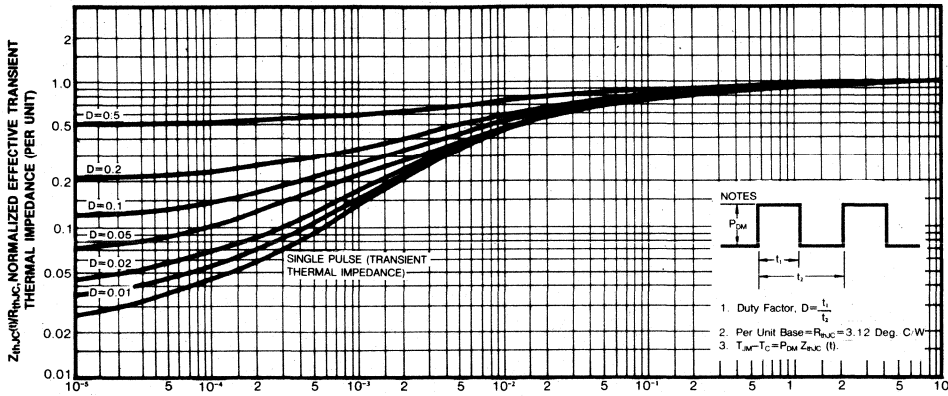

t1. SQUARE WAVE PULSE DURATION (SECONDS)
Maximum Effective Transient Thermal Impedance Junction-to-Case Vs. Pulse Duration

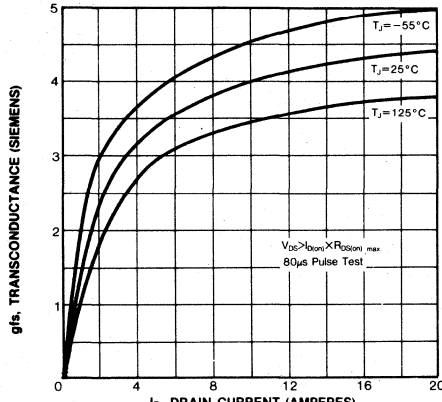

Typical Transconductance Vs. Drain Current

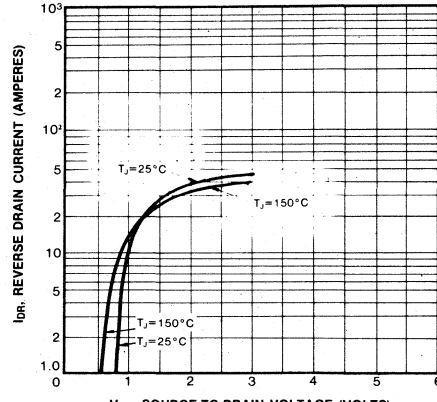

Typical Source-Drain Diode Forward Voltage

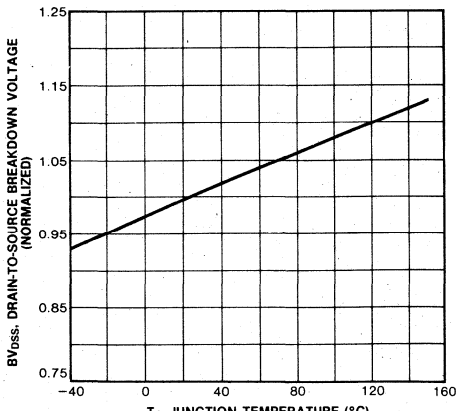

Breakdown Voltage Vs. Temperature

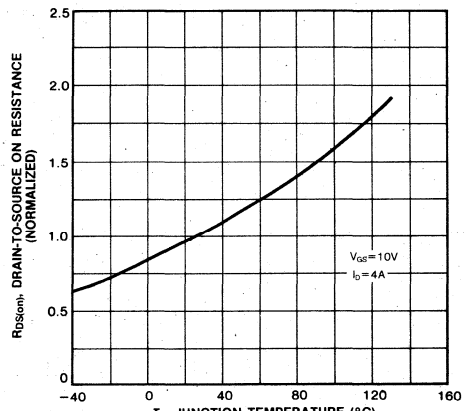

Normalized On-Resistance Vs. Temperature

IRF120/121/122/123

N-CHANNEL POWER MOSFETS

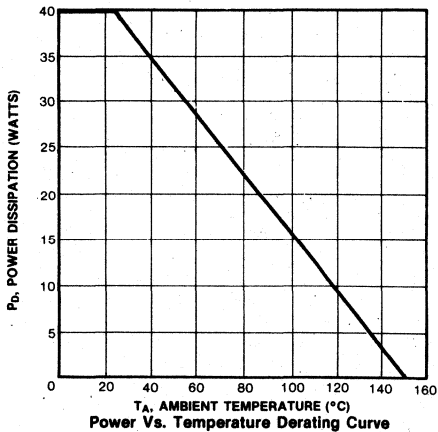
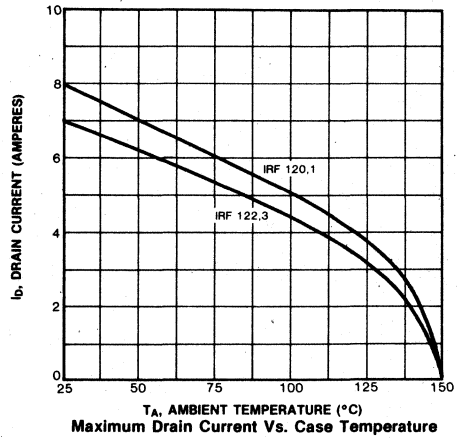
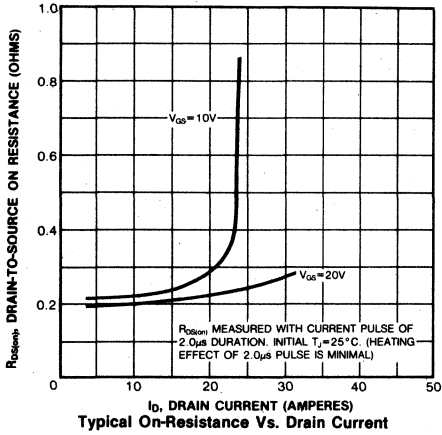
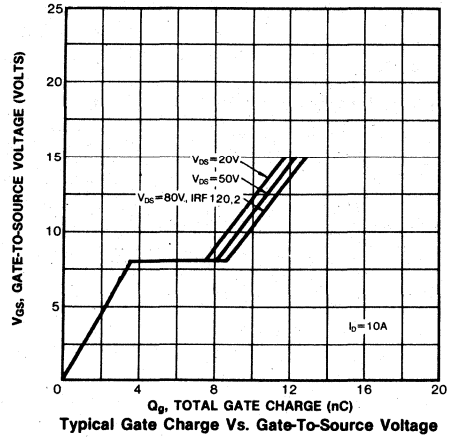
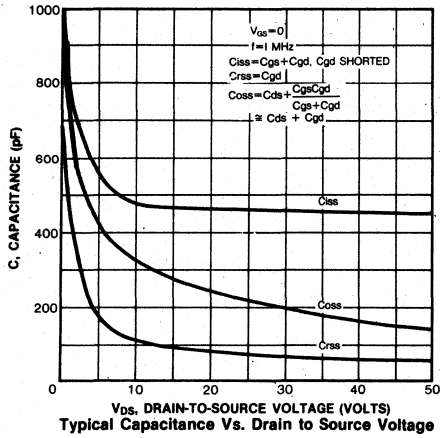

FEATURES

- Low $R_{DS(on)}$
- Improved inductive ruggedness
- Fast switching times
- Rugged polysilicon gate cell structure
- Low input capacitance
- Extended safe operating area
- Improved high temperature reliability
- TO-3 package (Standard)

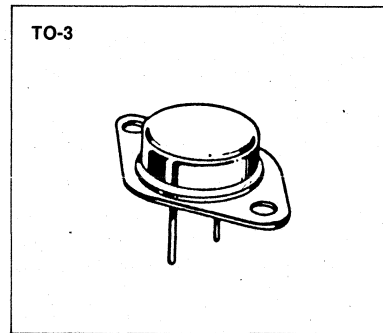

PRODUCT SUMMARY

Part Number	V_{DS}	$R_{DS(on)}$	I_D
IRF130	100V	0.18 Ω	14A
IRF131	60V	0.18 Ω	14A
IRF132	100V	0.25 Ω	12A
IRF133	60V	0.25 Ω	12A

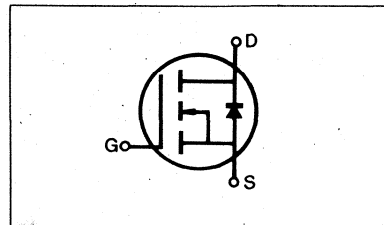

MAXIMUM RATINGS

Characteristic	Symbol	IRF130	IRF131	IRF132	IRF133	Unit
Drain-Source Voltage (1)	V_{DSS}	100	60	100	60	Vdc
Drain-Gate Voltage ($R_{GS}=1.0M\Omega$) (1)	V_{DGR}	100	60	100	60	Vdc
Gate-Source Voltage	V_{GS}	± 20				Vdc
Continuous Drain Current $T_C=25^\circ C$	I_D	14	14	12	12	Adc
Continuous Drain Current $T_C=100^\circ C$	I_D^*	9.0	9.0	8.0	8.0	Adc
Drain Current—Pulsed (3)	I_{DM}	56	56	48	48	Adc
Gate Current—Pulsed	I_{GM}	± 1.5				Adc
Total Power Dissipation @ $T_C=25^\circ C$ Derate above $25^\circ C$	P_D	75 0.6				Watts W/ $^\circ C$
Operating and Storage Junction Temperature Range	T_J, T_{stg}	-55 to 150				$^\circ C$
Maximum Lead Temp. for Soldering Purposes, 1/8" from case for 5 seconds	T_L	300				$^\circ C$

- Notes:** (1) $T_J=25^\circ C$ to $150^\circ C$
 (2) Pulse test: Pulse width $\leq 300\mu s$, Duty Cycle $\leq 2\%$
 (3) Repetitive rating: Pulse width limited by max. junction temperature

ELECTRICAL CHARACTERISTICS (T_C=25°C unless otherwise specified)

Characteristic	Symbol	Type	Min	Typ	Max	Units	Test Conditions
Drain-Source Breakdown Voltage	BV _{DSS}	IRF130 IRF132	100	—	—	V	V _{GS} =0V
		IRF131 IRF133	60	—	—	V	I _D =250μA
		ALL	2.0	—	4.0	V	V _{DS} =V _{GS} , I _D =250μA
Gate Threshold Voltage	V _{GS(th)}	ALL	2.0	—	4.0	V	V _{DS} =V _{GS} , I _D =250μA
Gate-Source Leakage Forward	I _{GSS}	ALL	—	—	100	nA	V _{GS} =20V
Gate-Source Leakage Reverse	I _{GSS}	ALL	—	—	-100	nA	V _{GS} =-20V
Zero Gate Voltage Drain Current	I _{DSS}	ALL	—	—	250	μA	V _{DS} =Max. Rating, V _{GS} =0V
		ALL	—	—	1000	μA	V _{DS} =Max. Rating×0.8, V _{GS} =0V, T _C =125°C
On-State Drain-Source Current (2)	I _{D(on)}	IRF130 IRF131	14	—	—	A	V _{DS} >I _{D(on)} ×R _{DS(on) max.} , V _{GS} =10V
		IRF132 IRF133	12	—	—	A	
Static Drain-Source On-State Resistance (2)	R _{DS(on)}	IRF130 IRF131	—	0.10	0.18	Ω	V _{GS} =10V, I _D =8.0A
		IRF132 IRF133	—	0.20	0.25	Ω	
Forward Transconductance (2)	g _{fs}	ALL	4.0	5.5	—	Ω	V _{DS} >I _{D(on)} ×R _{DS(on) max.} , I _D =8.0A
Input Capacitance	C _{iss}	ALL	—	680	800	pF	V _{GS} =0V, V _{DS} =25V, f=1.0MHz
Output Capacitance	C _{oss}	ALL	—	300	500	pF	
Reverse Transfer Capacitance	C _{rss}	ALL	—	100	150	pF	
Turn-On Delay Time	t _{d(on)}	ALL	—	—	30	ns	
Rise Time	t _r	ALL	—	—	75	ns	V _{DD} =0.5BV _{DSS} , I _D =8.0A, Z _O =15 Ω (MOSFET switching times are essentially independent of operating temperature.)
Turn-Off Delay Time	t _{d(off)}	ALL	—	—	40	ns	
Fall Time	t _f	ALL	—	—	45	ns	
Total Gate Charge (Gate-Source Plus Gate-Drain)	Q _g	ALL	—	18	30	nC	V _{GS} =10V, I _D =18A, V _{DS} =0.8 Max. Rating (Gate charge is essentially independent of operating temperature.)
Gate-Source Charge	Q _{gs}	ALL	—	6.0	—	nC	
Gate-Drain ("Miller") Charge	Q _{gd}	ALL	—	12.0	—	nC	

THERMAL RESISTANCE

Junction-to-Case	R _{thJC}	ALL	—	—	1.67	K/W	
Case-to-Sink	R _{thCS}	ALL	—	0.1	—	K/W	Mounting surface flat, smooth, and greased
Junction-to-Ambient	R _{thJA}	ALL	—	—	30	K/W	Free Air Operation

- Notes:** (1) T_J=25°C to 150°C
 (2) Pulse test: Pulse width≤300μs, Duty Cycle≤2%
 (3) Repetitive rating: Pulse width limited by max. junction temperature

SOURCE-DRAIN DIODE RATINGS AND CHARACTERISTICS

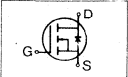
Characteristic	Symbol	Type	Min	Typ	Max	Units	Test Conditions
Continuous Source Current (Body Diode)	I_S	IRF130	—	—	14	A	Modified MOSFET symbol showing the integral reverse P-N junction rectifier 
		IRF131	—	—	14	A	
Pulse Source Current (Body Diode) (3)	I_{SM}	IRF130	—	—	56	A	
		IRF131	—	—	56	A	
Diode Forward Voltage (2)	V_{SD}	IRF130	—	—	2.5	V	$T_C=25^\circ\text{C}$, $I_S=14\text{A}$, $V_{GS}=0\text{V}$
		IRF131	—	—	2.5	V	$T_C=25^\circ\text{C}$, $I_S=12\text{A}$, $V_{GS}=0\text{V}$
Reverse Recovery Time	t_{rr}	ALL	—	360	—	ns	$T_J=150^\circ\text{C}$, $I_F=14\text{A}$, $dI_F/dt=100\text{A}/\mu\text{s}$

Notes: (1) $T_J=25^\circ\text{C}$ to 150°C (2) Pulse test: Pulse width $\leq 300\mu\text{s}$, Duty Cycle $\leq 2\%$
 (3) Repetitive rating: Pulse width limited by max. junction temperature

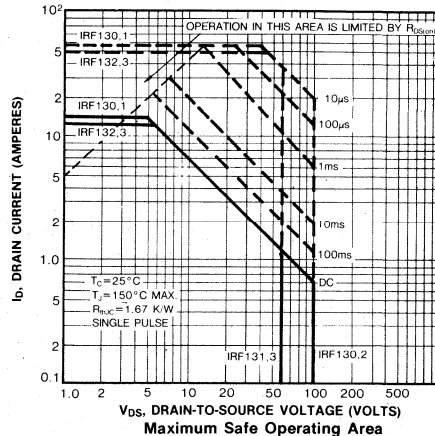
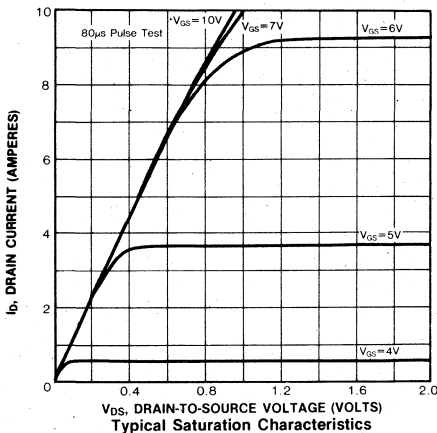
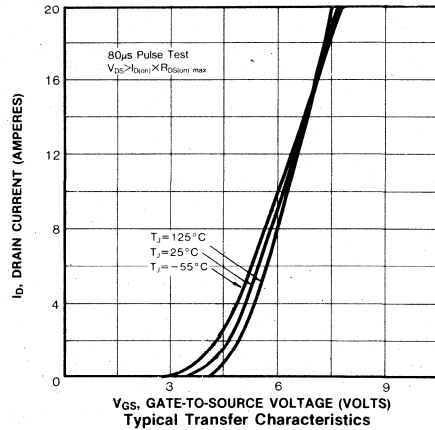
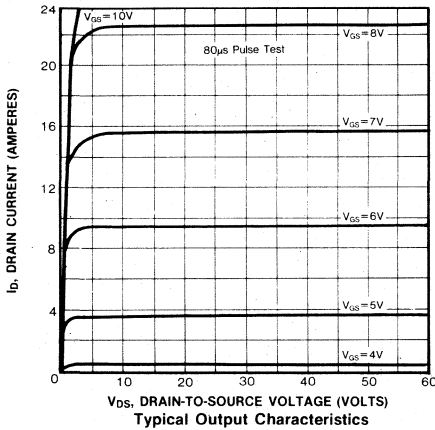

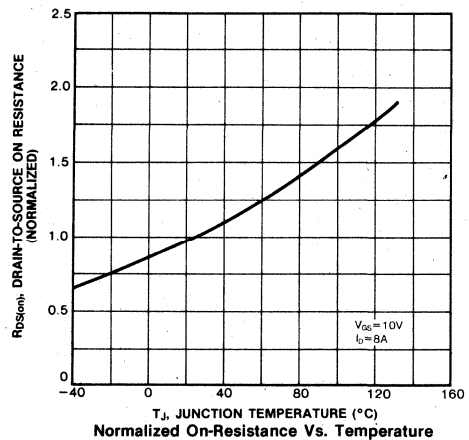
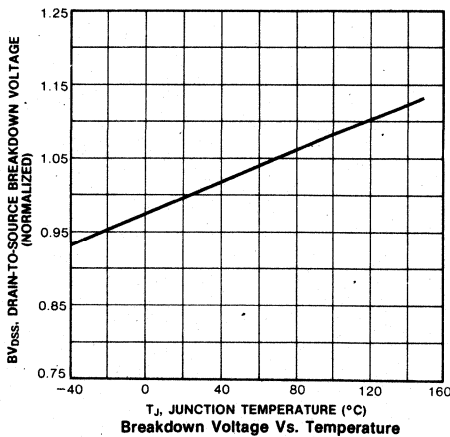
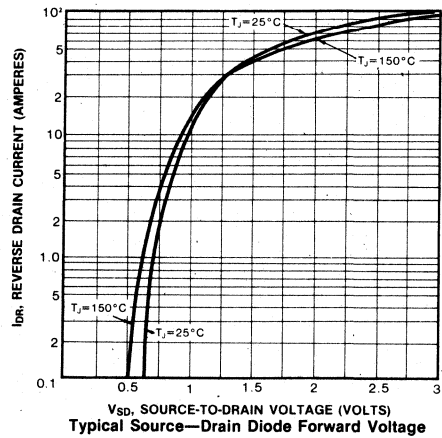
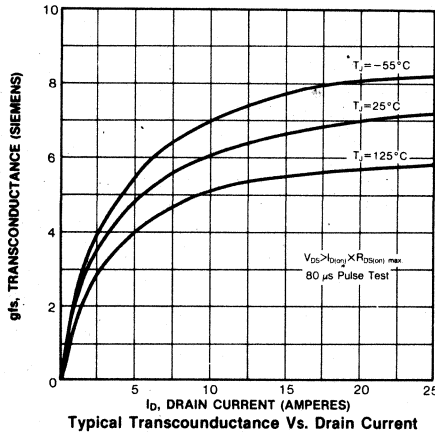
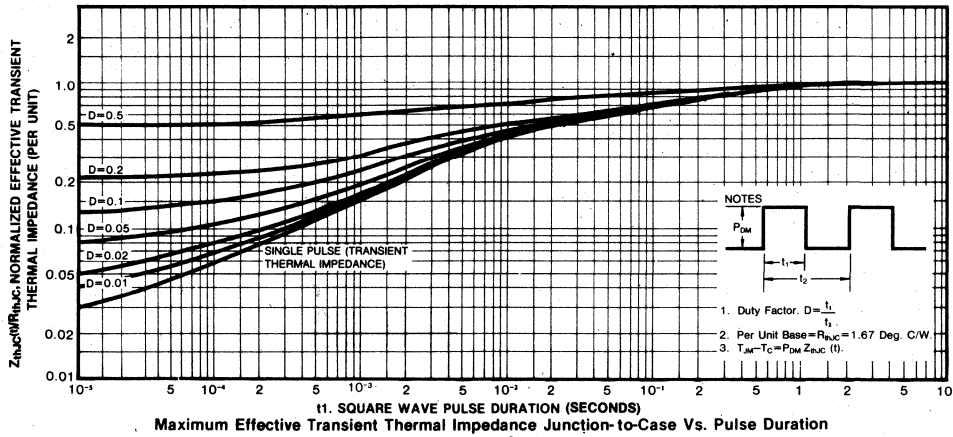

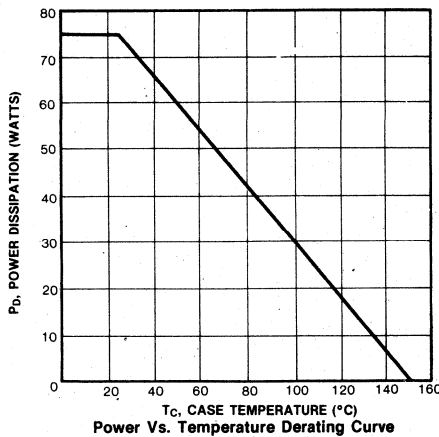
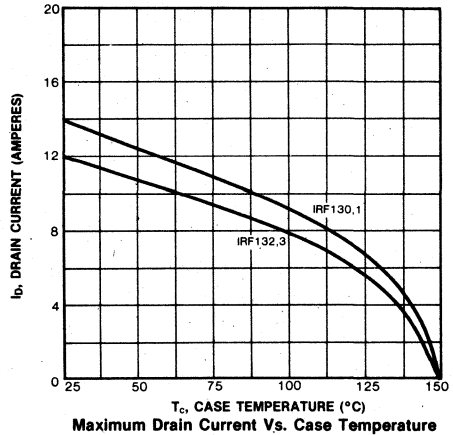
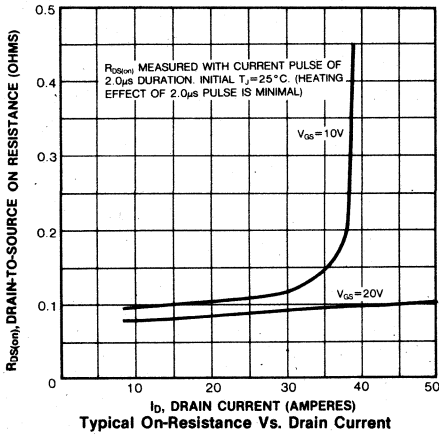
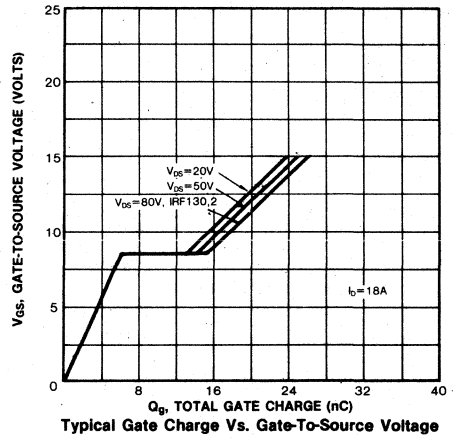
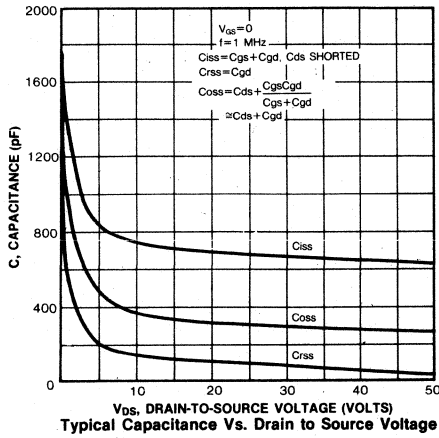

4

FEATURES

- Low $R_{DS(on)}$
- Improved inductive ruggedness
- Fast switching times
- Rugged polysilicon gate cell structure
- Low input capacitance
- Extended safe operating area
- Improved high temperature reliability
- TO-3 package (High current)

PRODUCT SUMMARY

Part Number	V_{DS}	$R_{DS(on)}$	I_D
IRF140	100V	0.085 Ω	27A
IRF141	60V	0.085 Ω	27A
IRF142	100V	0.11 Ω	24A
IRF143	60V	0.11 Ω	24A

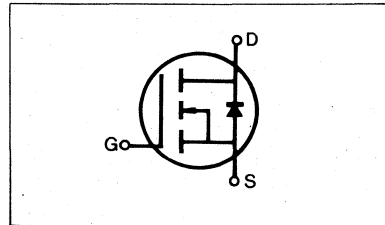
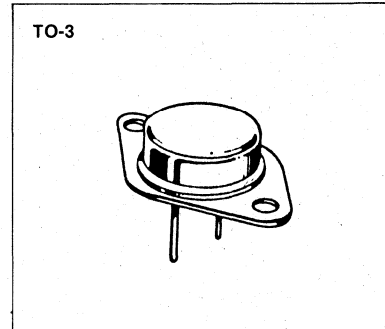

MAXIMUM RATINGS

Characteristic	Symbol	IRF140	IRF141	IRF142	IRF143	Unit
Drain-Source Voltage (1)	V_{DSS}	100	60	100	60	Vdc
Drain-Gate Voltage ($R_{GS}=1.0M\Omega$) (1)	V_{DGR}	100	60	100	60	Vdc
Gate-Source Voltage	V_{GS}	± 20				Vdc
Continuous Drain Current $T_C=25^\circ C$	I_D	27	27	24	24	Adc
Continuous Drain Current $T_C=100^\circ C$	I_D	17	17	15	15	Adc
Drain Current—Pulsed (3)	I_{DM}	108	108	96	96	Adc
Gate Current—Pulsed	I_{GM}	± 1.5				Adc
Total Power Dissipation @ $T_C=25^\circ C$ Derate above $25^\circ C$	P_D	125 1.0				Watts W/ $^\circ C$
Operating and Storage Junction Temperature Range	T_J, T_{stg}	-55 to 150				$^\circ C$
Maximum Lead Temp. for Soldering Purposes, 1/8" from case for 5 seconds	T_L	300				$^\circ C$

- Notes:** (1) $T_J=25^\circ C$ to $150^\circ C$
 (2) Pulse test: Pulse width $\leq 300\mu s$, Duty Cycle $\leq 2\%$
 (3) Repetitive rating: Pulse width limited by max. junction temperature

ELECTRICAL CHARACTERISTICS (T_C=25°C unless otherwise specified)

Characteristic	Symbol	Type	Min	Typ	Max	Units	Test Conditions
Drain-Source Breakdown Voltage	BV _{DSS}	IRF140 IRF142	100	—	—	V	V _{GS} =0V
		IRF141 IRF143	60	—	—	V	I _D =250μA
Gate Threshold Voltage	V _{GS(th)}	ALL	2.0	—	4.0	V	V _{DS} =V _{GS} , I _D =250μA
Gate-Source Leakage Forward	I _{GSS}	ALL	—	—	100	nA	V _{GS} =20V
Gate-Source Leakage Reverse	I _{GSS}	ALL	—	—	-100	nA	V _{GS} =-20V
Zero Gate Voltage Drain Current	I _{DSS}	ALL	—	—	250	μA	V _{DS} =Max. Rating, V _{GS} =0V
			—	—	1000	μA	V _{DS} =Max. Rating×0.8, V _{GS} =0V, T _C =125°C
On-State Drain-Source Current (2)	I _{D(on)}	IRF140 IRF141	27	—	—	A	V _{DS} >I _{D(on)} ×R _{DS(on) max.} , V _{GS} =10V
		IRF142 IRF143	24	—	—	A	
Static Drain-Source On-State Resistance (2)	R _{DS(on)}	IRF140 IRF141	—	0.06	0.085	Ω	V _{GS} =10V, I _D =15A
		IRF142 IRF143	—	0.09	0.11	Ω	
Forward Transconductance (2)	g _{fs}	ALL	6.0	10.5	—	S	V _{DS} >I _{D(on)} ×R _{DS(on) max.} , I _D =15A
Input Capacitance	C _{iss}	ALL	—	1320	1600	pF	V _{GS} =0V, V _{DS} =25V, f=1.0MHz
Output Capacitance	C _{oss}	ALL	—	600	800	pF	
Reverse Transfer Capacitance	C _{rss}	ALL	—	250	300	pF	V _{DD} =0.5BV _{DSS} , I _D =15A, Z ₀ =4.7 Ω (MOSFET switching times are essentially independent of operating temperature.)
Turn-On Delay Time	t _{d(on)}	ALL	—	—	30	ns	
Rise Time	t _r	ALL	—	—	60	ns	
Turn-Off Delay Time	t _{d(off)}	ALL	—	—	80	ns	
Fall Time	t _f	ALL	—	—	30	ns	V _{GS} =10V, I _D =34A, V _{DS} =0.8 Max. Rating (Gate charge is essentially independent of operating temperature.)
Total Gate Charge (Gate-Source Plus Gate-Drain)	Q _g	ALL	—	39	60	nC	
Gate-Source Charge	Q _{gs}	ALL	—	12	—	nC	
Gate-Drain ("Miller") Charge	Q _{gd}	ALL	—	27	—	nC	

THERMAL RESISTANCE

Junction-to-Case	R _{thJC}	ALL	—	—	1.0	K/W	
Case-to-Sink	R _{thCS}	ALL	—	0.1	—	K/W	Mounting surface flat, smooth, and greased
Junction-to-Ambient	R _{thJA}	ALL	—	—	30	K/W	Free Air Operation

- Notes:** (1) T_J=25°C to 150°C
 (2) Pulse test: Pulse width≤300μs, Duty Cycle≤2%
 (3) Repetitive rating: Pulse width limited by max. junction temperature

SOURCE-DRAIN DIODE RATINGS AND CHARACTERISTICS

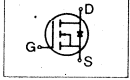
Characteristic	Symbol	Type	Min	Typ	Max	Units	Test Conditions
Continuous Source Current (Body Diode)	I_S	IRF140	—	—	27	A	Modified MOSFET symbol showing the integral reverse P-N junction rectifier 
		IRF141	—	—	27	A	
		IRF142	—	—	24	A	
		IRF143	—	—	24	A	
Pulse Source Current (Body Diode) (3)	I_{SM}	IRF140	—	—	108	A	
		IRF141	—	—	108	A	
		IRF142	—	—	96	A	
		IRF143	—	—	96	A	
Diode Forward Voltage (2)	V_{SD}	IRF140	—	—	2.5	V	$T_C=25^\circ\text{C}$, $I_S=27\text{A}$, $V_{GS}=0\text{V}$
		IRF141	—	—	2.5	V	$T_C=25^\circ\text{C}$, $I_S=27\text{A}$, $V_{GS}=0\text{V}$
		IRF142	—	—	2.3	V	$T_C=25^\circ\text{C}$, $I_S=24\text{A}$, $V_{GS}=0\text{V}$
		IRF143	—	—	2.3	V	$T_C=25^\circ\text{C}$, $I_S=24\text{A}$, $V_{GS}=0\text{V}$
Reverse Recovery Time	t_{rr}	ALL	—	500	—	ns	$T_J=150^\circ\text{C}$, $I_F=27\text{A}$, $di/dt=100\text{A}/\mu\text{s}$

Notes: (1) $T_J=25^\circ\text{C}$ to 150°C (2) Pulse test: Pulse width $\leq 300\mu\text{s}$, Duty Cycle $\leq 2\%$
 (3) Repetitive rating: Pulse width limited by max. junction temperature

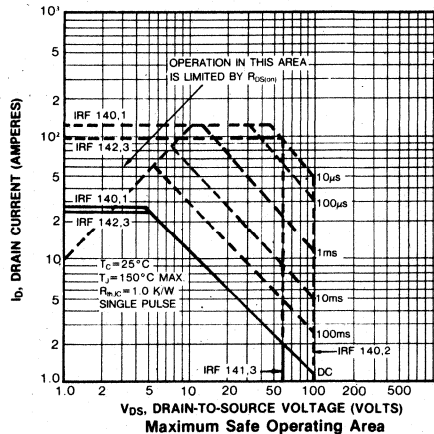
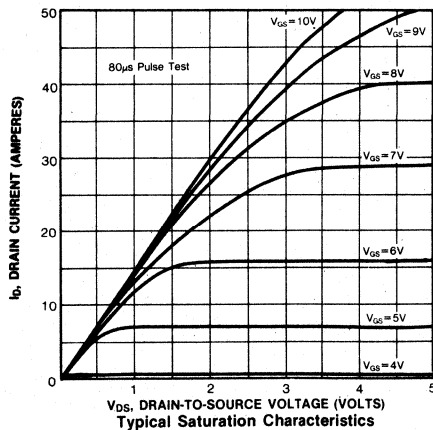
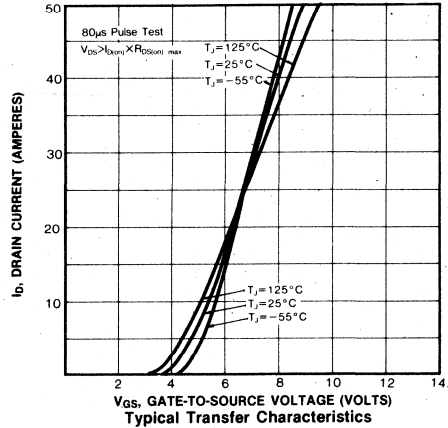
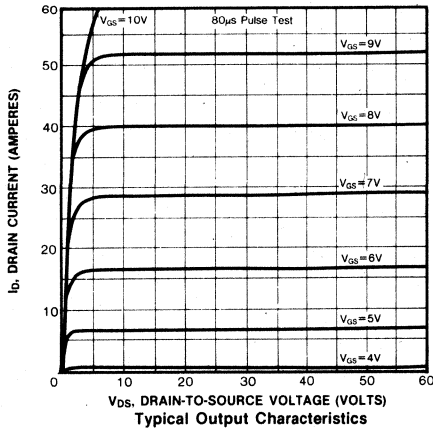

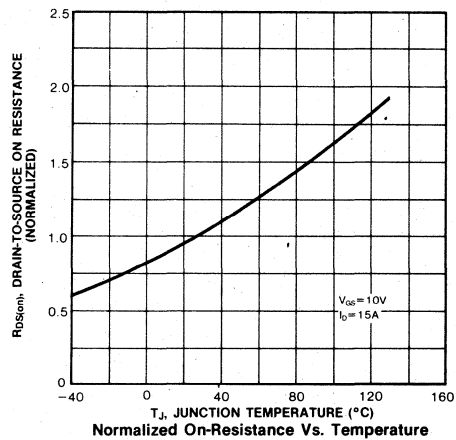
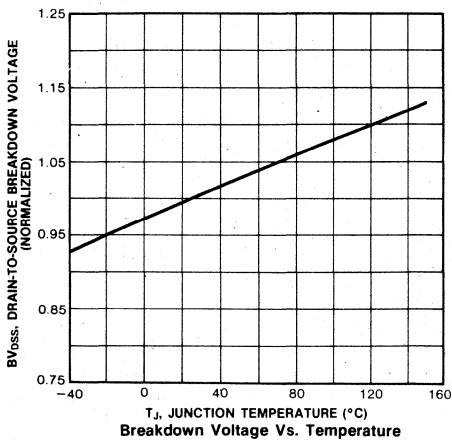
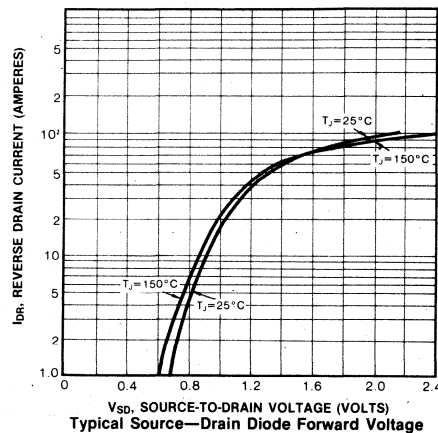
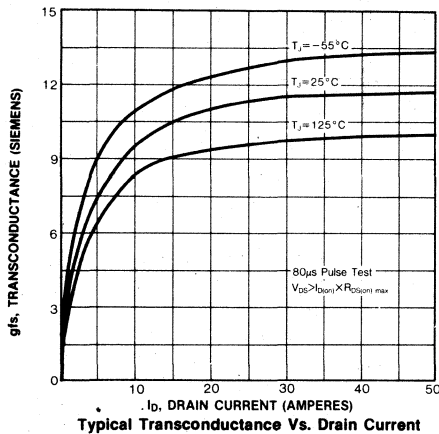
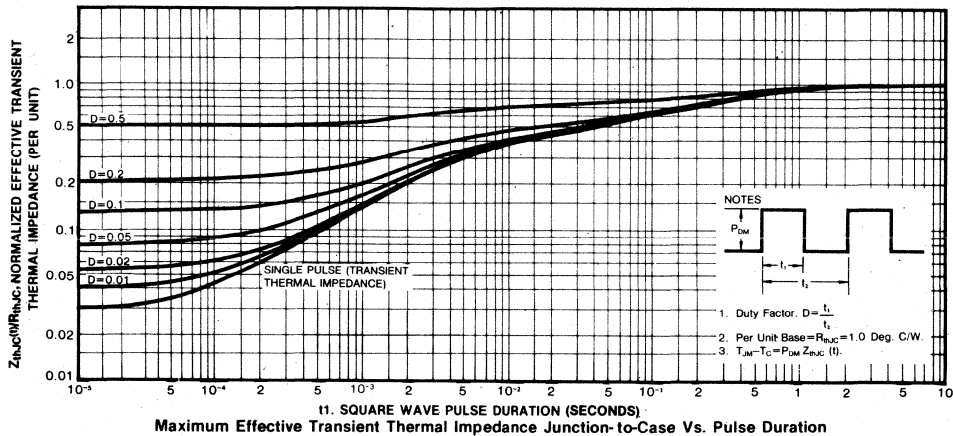

IRF140/141/142/143

N-CHANNEL POWER MOSFETS

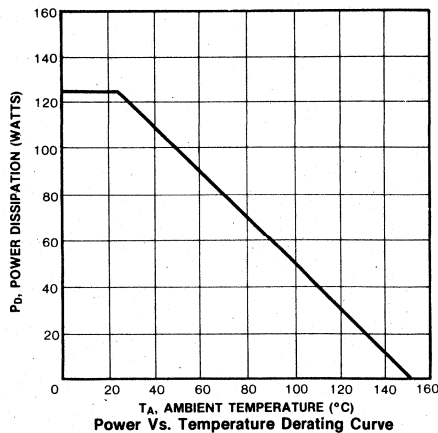
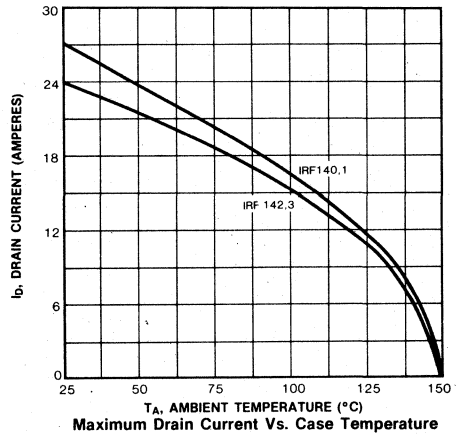
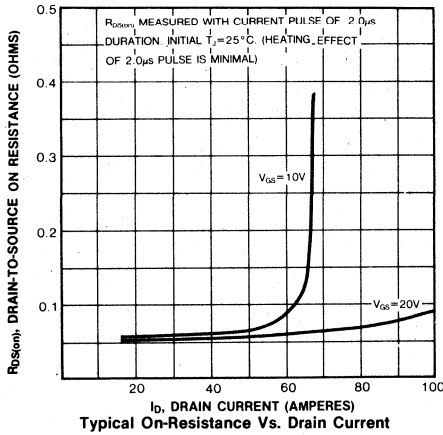
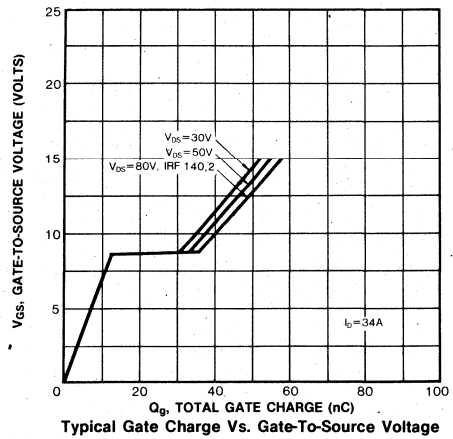
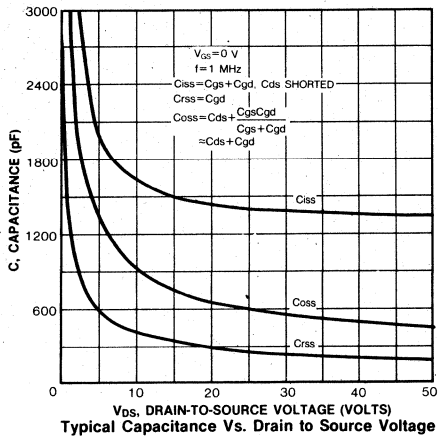

FEATURES

- Low $R_{DS(on)}$
- Improved inductive ruggedness
- Fast switching times
- Rugged polysilicon gate cell structure
- Low input capacitance
- Extended safe operating area
- Improved high temperature reliability
- TO-3 package (High current)

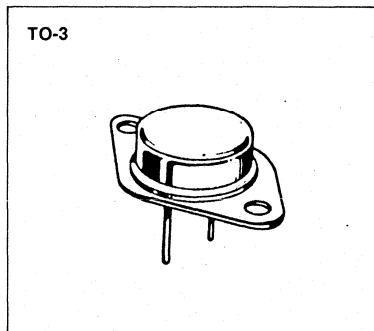

PRODUCT SUMMARY

Part Number	V_{DS}	$R_{DS(on)}$	I_D
IRF150	100V	0.055 Ω	40A
IRF151	60V	0.055 Ω	40A
IRF152	100V	0.08 Ω	33A
IRF153	60V	0.08 Ω	33A

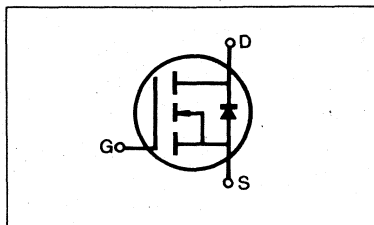

4

MAXIMUM RATINGS

Characteristic	Symbol	IRF150	IRF151	IRF152	IRF153	Unit
Drain-Source Voltage (1)	V_{DSS}	100	60	100	60	Vdc
Drain-Gate Voltage ($R_{GS}=1.0M\Omega$) (1)	V_{DGR}	100	60	100	60	Vdc
Gate-Source Voltage	V_{GS}	± 20				Vdc
Continuous Drain Current $T_C=25^\circ C$	I_D	40	40	33	33	Adc
Continuous Drain Current $T_C=100^\circ C$	I_D	25	25	20	20	Adc
Drain Current—Pulsed (3)	I_{DM}	160	160	132	132	Adc
Gate Current—Pulsed	I_{GM}	± 1.5				Adc
Total Power Dissipation @ $T_C=25^\circ C$	P_D	150				Watts
Derate above $25^\circ C$		1.2				W/ $^\circ C$
Operating and Storage Junction Temperature Range	T_J, T_{stg}	-55 to 150				$^\circ C$
Maximum Lead Temp. for Soldering Purposes, 1/8" from case for 5 seconds	T_L	300				$^\circ C$

- Notes: (1) $T_J=25^\circ C$ to $150^\circ C$
 (2) Pulse test: Pulse width $\leq 300\mu s$, Duty Cycle $\leq 2\%$
 (3) Repetitive rating: Pulse width limited by max. junction temperature

ELECTRICAL CHARACTERISTICS (T_C=25°C unless otherwise specified)

Characteristic	Symbol	Type	Min	Typ	Max	Units	Test Conditions
Drain-Source Breakdown Voltage	BV _{DSS}	IRF150 IRF152	100	—	—	V	V _{GS} =0V
		IRF151 IRF153	60	—	—	V	I _D =250μA
Gate Threshold Voltage	V _{GS(th)}	ALL	2.0	—	4.0	V	V _{DS} =V _{GS} , I _D =250μA
Gate-Source Leakage Forward	I _{GSS}	ALL	—	—	100	nA	V _{GS} =20V
Gate-Source Leakage Reverse	I _{GSS}	ALL	—	—	-100	nA	V _{GS} =-20V
Zero Gate Voltage Drain Current	I _{DSS}	ALL	—	—	250	μA	V _{DS} =Max. Rating, V _{GS} =0V
			—	—	1000	μA	V _{DS} =Max. Rating×0.8, V _{GS} =0V, T _C =125°C
On-State Drain-Source Current (2)	I _{D(on)}	IRF150 IRF151	40	—	—	A	V _{DS} >I _{D(on)} ×R _{DS(on) max.} , V _{GS} =10V
		IRF152 IRF153	33	—	—	A	
Static Drain-Source On-State Resistance (2)	R _{DS(on)}	IRF150 IRF151	—	0.04	0.055	Ω	V _{GS} =10V, I _D =20A
		IRF152 IRF153	—	0.06	0.08	Ω	
Forward Transconductance (2)	g _{fs}	ALL	9.0	12.3	—	♯	V _{DS} >I _{D(on)} ×R _{DS(on) max.} , I _D =20A
Input Capacitance	C _{iss}	ALL	—	2900	3000	pF	V _{GS} =0V, V _{DS} =25V, f=1.0MHz
Output Capacitance	C _{oss}	ALL	—	1050	1500	pF	
Reverse Transfer Capacitance	C _{rss}	ALL	—	450	500	pF	
Turn-On Delay Time	t _{d(on)}	ALL	—	—	35	ns	V _{DD} =0.5BV _{DSS} , I _D =20A, Z _O =4.7Ω (MOSFET switching times are essentially independent of operating temperature.)
Rise Time	t _r	ALL	—	—	100	ns	
Turn-Off Delay Time	t _{d(off)}	ALL	—	—	125	ns	
Fall Time	t _f	ALL	—	—	100	ns	
Total Gate Charge (Gate-Source Plus Gate-Drain)	Q _g	ALL	—	72	120	nC	V _{GS} =10V, I _D =50A, V _{DS} =0.8 Max. Rating (Gate charge is essentially independent of operating temperature.)
Gate-Source Charge	Q _{gs}	ALL	—	18	—	nC	
Gate-Drain ("Miller") Charge	Q _{gd}	ALL	—	54	—	nC	

THERMAL RESISTANCE

Junction-to-Case	R _{thJC}	ALL	—	—	0.83	K/W	
Case-to-Sink	R _{thCS}	ALL	—	0.1	—	K/W	Mounting surface flat, smooth, and greased
Junction-to-Ambient	R _{thJA}	ALL	—	—	30	K/W	Free Air Operation

Notes: (1) T_J=25°C to 150°C

(2) Pulse test: Pulse width≤300μs, Duty Cycle≤2%

(3) Repetitive rating: Pulse width limited by max. junction temperature

SOURCE-DRAIN DIODE RATINGS AND CHARACTERISTICS

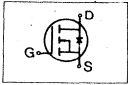
Characteristic	Symbol	Type	Min	Typ	Max	Units	Test Conditions
Continuous Source Current (Body Diode)	I _S	IRF150	—	—	40	A	Modified MOSFET symbol showing the integral reverse P-N junction rectifier 
		IRF151	—	—	40	A	
		IRF152	—	—	33	A	
		IRF153	—	—	33	A	
Pulse Source Current (Body Diode) (3)	I _{SM}	IRF150	—	—	160	A	
		IRF151	—	—	160	A	
		IRF152	—	—	132	A	
		IRF153	—	—	132	A	
Diode Forward Voltage (2)	V _{SD}	IRF150	—	—	2.5	V	T _C =25°C, I _S =40A, V _{GS} =0V
		IRF151	—	—	2.5	V	T _C =25°C, I _S =40A, V _{GS} =0V
		IRF152	—	—	2.3	V	T _C =25°C, I _S =33A, V _{GS} =0V
		IRF153	—	—	2.3	V	T _C =25°C, I _S =33A, V _{GS} =0V
Reverse Recovery Time	t _{rr}	ALL	—	600	—	ns	T _J =150°C, I _F =40A, dI _F /dt=100A/μs

Notes: (1) T_J=25°C to 150°C (2) Pulse test: Pulse width ≤ 300μs, Duty Cycle ≤ 2%
 (3) Repetitive rating: Pulse width limited by max. junction temperature

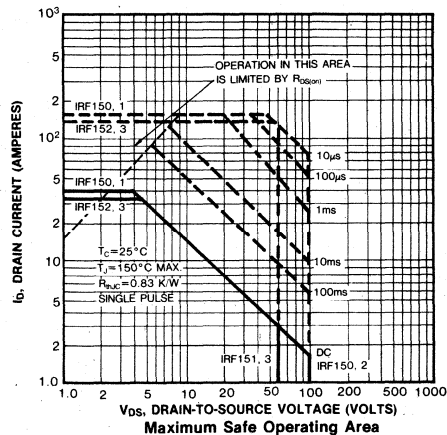
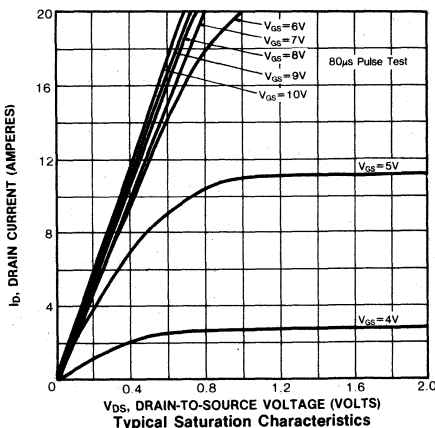
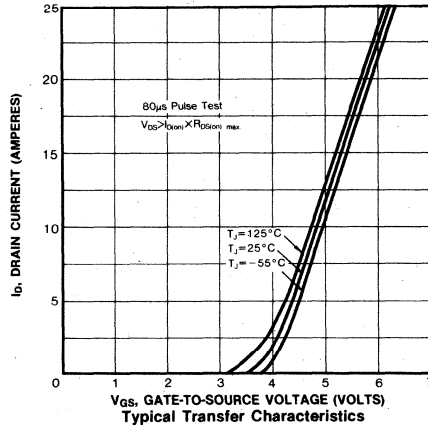
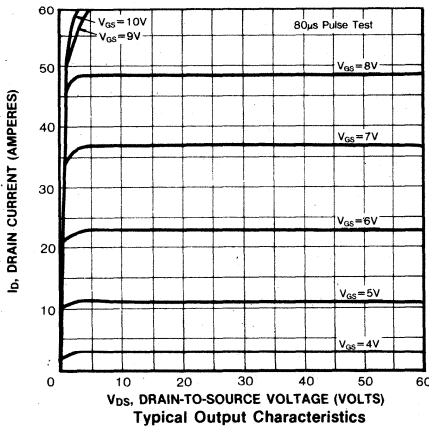

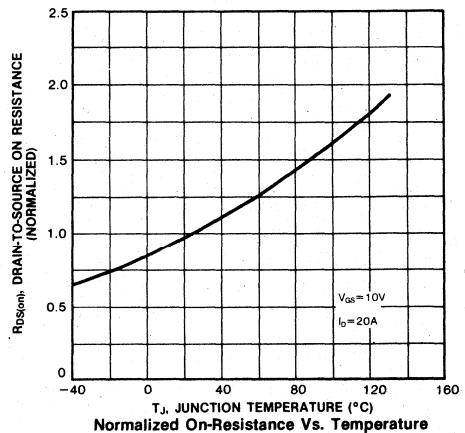
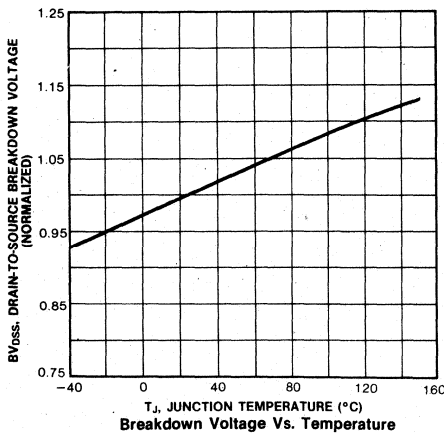
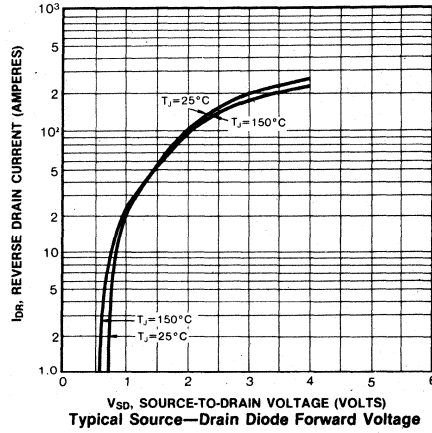
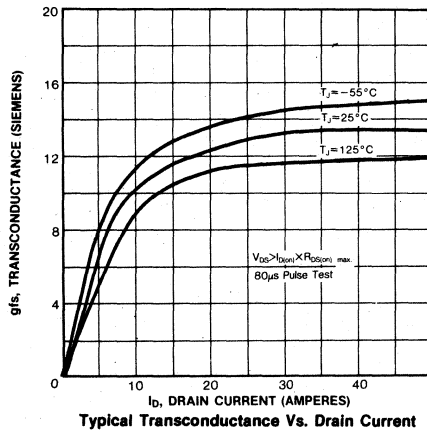
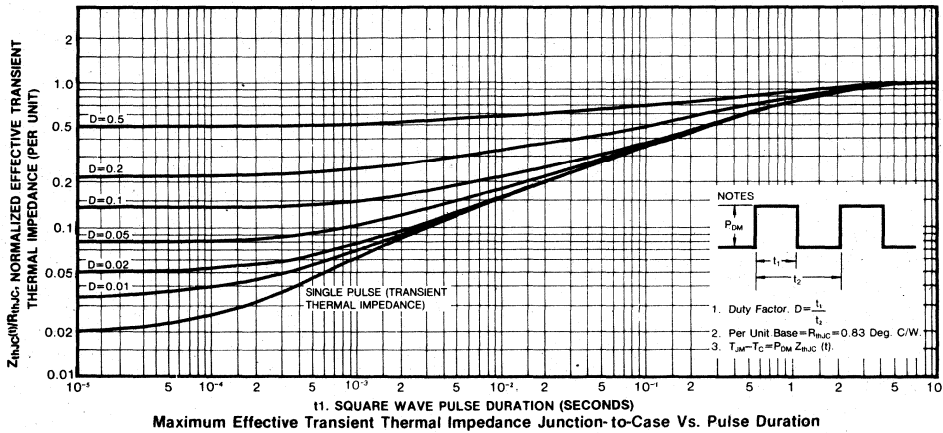

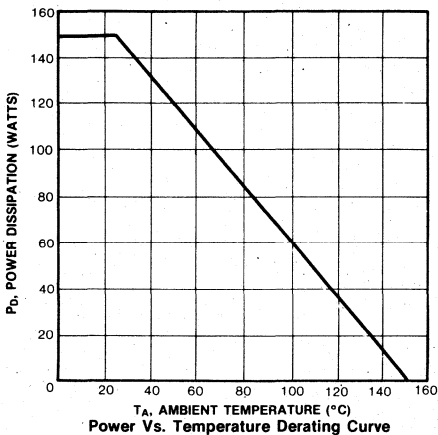
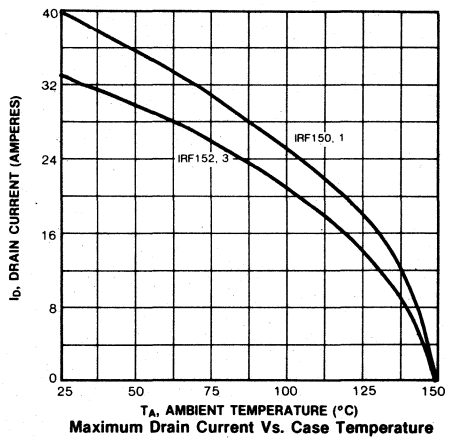
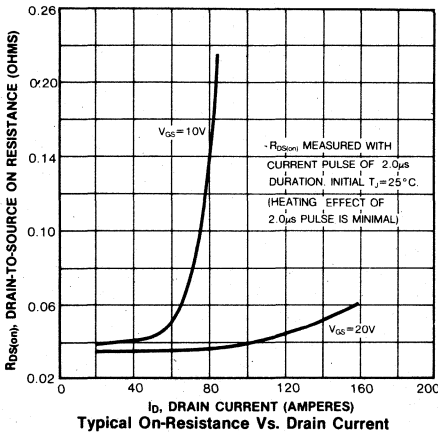
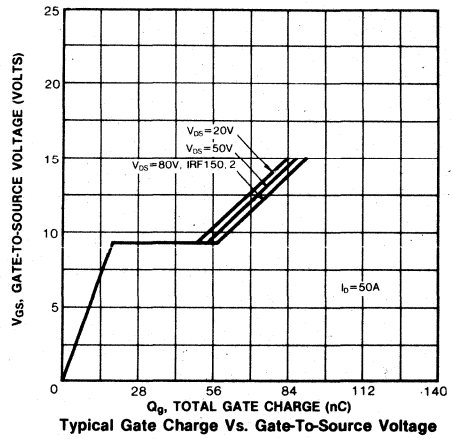
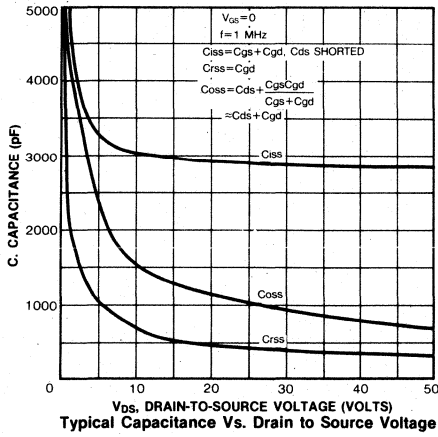

FEATURES

- Low $R_{DS(on)}$
- Improved inductive ruggedness
- Fast switching times
- Rugged polysilicon gate cell structure
- Low input capacitance
- Extended safe operating area
- Improved high temperature reliability
- TO-3 package (Standard)

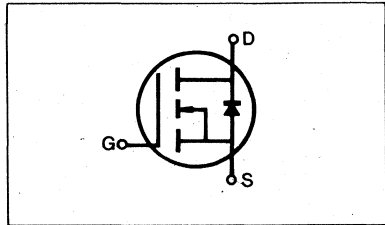
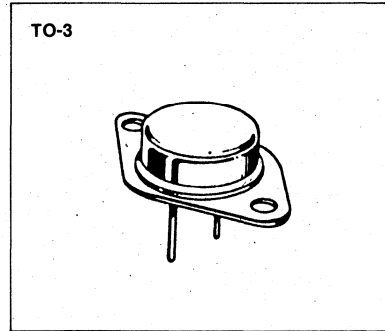

PRODUCT SUMMARY

Part Number	V_{DS}	$R_{DS(on)}$	I_D
IRF220	200V	0.80 Ω	5.0A
IRF221	150V	0.80 Ω	5.0A
IRF222	200V	1.2 Ω	4.0A
IRF223	150V	1.2 Ω	4.0A

MAXIMUM RATINGS

Characteristic	Symbol	IRF220	IRF221	IRF222	IRF223	Unit
Drain-Source Voltage (1)	V_{DSS}	200	150	200	150	Vdc
Drain-Gate Voltage ($R_{GS}=1.0M\Omega$) (1)	V_{DGR}	200	150	200	150	Vdc
Gate-Source Voltage	V_{GS}	± 20				Vdc
Continuous Drain Current $T_C=25^\circ C$	I_D	5.0	5.0	4.0	4.0	Adc
Continuous Drain Current $T_C=100^\circ C$	I_D	3.0	3.0	2.0	2.0	Adc
Drain Current—Pulsed (3)	I_{DM}	20	20	16	16	Adc
Gate Current—Pulsed	I_{GM}	± 1.5				Adc
Total Power Dissipation @ $T_C=25^\circ C$ Derate above $25^\circ C$	P_D	40 0.32				Watts W/ $^\circ C$
Operating and Storage Junction Temperature Range	T_J, T_{stg}	-55 to 150				$^\circ C$
Maximum Lead Temp. for Soldering Purposes, 1/8" from case for 5 seconds	T_L	300				$^\circ C$

- Notes:** (1) $T_J=25^\circ C$ to $150^\circ C$
 (2) Pulse test: Pulse width $\leq 300\mu s$, Duty Cycle $\leq 2\%$
 (3) Repetitive rating: Pulse width limited by max. junction temperature

ELECTRICAL CHARACTERISTICS (T_C=25°C unless otherwise specified)

Characteristic	Symbol	Type	Min	Typ	Max	Units	Test Conditions
Drain-Source Breakdown Voltage	BV _{DSS}	IRF220 IRF222	200	—	—	V	V _{GS} =0V
		IRF221 IRF223	150	—	—	V	I _D =250μA
Gate Threshold Voltage	V _{GS(th)}	ALL	2.0	—	4.0	V	V _{DS} =V _{GS} , I _D =250μA
Gate-Source Leakage Forward	I _{GSS}	ALL	—	—	100	nA	V _{GS} =20V
Gate-Source Leakage Reverse	I _{GSS}	ALL	—	—	-100	nA	V _{GS} =-20V
Zero Gate Voltage Drain Current	I _{DSS}	ALL	—	—	250	μA	V _{DS} =Max. Rating, V _{GS} =0V
			—	—	1000	μA	V _{DS} =Max. Rating×0.8, V _{GS} =0V, T _C =125°C
On-State Drain-Source Current (2)	I _{D(on)}	IRF220 IRF221	5.0	—	—	A	V _{DS} >I _{D(on)} ×R _{DS(on) max.} , V _{GS} =10V
		IRF222 IRF223	4.0	—	—	A	
Static Drain-Source On-State Resistance (2)	R _{DS(on)}	IRF220 IRF221	—	0.4	0.8	Ω	V _{GS} =10V, I _D =2.5A
		IRF222 IRF223	—	0.8	1.2	Ω	
Forward Transconductance (2)	g _{fs}	ALL	1.3	2.8	—	Ω	V _{DS} >I _{D(on)} ×R _{DS(on) max.} , I _D =2.5A
Input Capacitance	C _{iss}	ALL	—	450	600	pF	V _{GS} =0V, V _{DS} =25V, f=1.0MHz
Output Capacitance	C _{oss}	ALL	—	150	300	pF	
Reverse Transfer Capacitance	C _{rss}	ALL	—	50	80	pF	
Turn-On Delay Time	t _{d(on)}	ALL	—	—	40	ns	V _{DD} =0.5BV _{DSS} , I _D =2.5A, Z _O =50Ω (MOSFET switching times are essentially independent of operating temperature.)
Rise Time	t _r	ALL	—	—	60	ns	
Turn-Off Delay Time	t _{d(off)}	ALL	—	—	100	ns	
Fall Time	t _f	ALL	—	—	60	ns	
Total Gate Charge (Gate-Source Plus Gate-Drain)	Q _g	ALL	—	12.5	15	nC	V _{GS} =10V, I _D =6.0A, V _{DS} =0.8 Max. Rating (Gate charge is essentially independent of operating temperature.)
Gate-Source Charge	Q _{gs}	ALL	—	4.0	—	nC	
Gate-Drain ("Miller") Charge	Q _{gd}	ALL	—	8.5	—	nC	

THERMAL RESISTANCE

Junction-to-Case	R _{thJC}	ALL	—	—	3.12	K/W	
Case-to-Sink	R _{thCS}	ALL	—	0.1	—	K/W	Mounting surface flat, smooth, and greased
Junction-to-Ambient	R _{thJA}	ALL	—	—	30	K/W	Free Air Operation

- Notes:** (1) T_J=25°C to 150°C
 (2) Pulse test: Pulse width≤300μs, Duty Cycle≤2%
 (3) Repetitive rating: Pulse width limited by max. junction temperature

SOURCE-DRAIN DIODE RATINGS AND CHARACTERISTICS

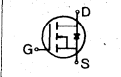
Characteristic	Symbol	Type	Min	Typ	Max	Units	Test Conditions
Continuous Source Current (Body Diode)	I _S	IRF220	—	—	5.0	A	Modified MOSFET symbol showing the integral reverse P-N junction rectifier 
		IRF221	—	—	5.0	A	
		IRF222	—	—	4.0	A	
		IRF223	—	—	4.0	A	
Pulse Source Current (Body Diode) (3)	I _{SM}	IRF220	—	—	20	A	
		IRF221	—	—	20	A	
		IRF222	—	—	16	A	
		IRF223	—	—	16	A	
Diode Forward Voltage (2)	V _{SD}	IRF220	—	—	2.0	V	T _C =25°C, I _S =5.0A, V _{GS} =0V
		IRF221	—	—	2.0	V	T _C =25°C, I _S =5.0A, V _{GS} =0V
		IRF222	—	—	1.8	V	T _C =25°C, I _S =4.0A, V _{GS} =0V
Reverse Recovery Time	t _{rr}	ALL	—	350	—	ns	T _J =150°C, I _F =5.0A, dI _F /dt=100A/μs

Notes: (1) T_J=25°C to 150°C (2) Pulse test: Pulse width≤300μs, Duty Cycle≤2% (3) Repetitive rating: Pulse width limited by max. junction temperature.

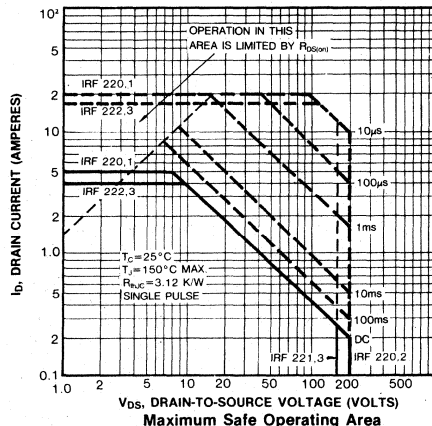
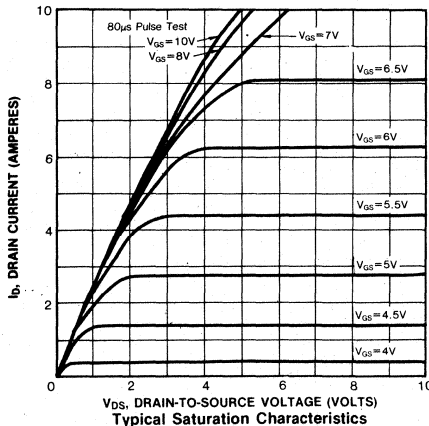
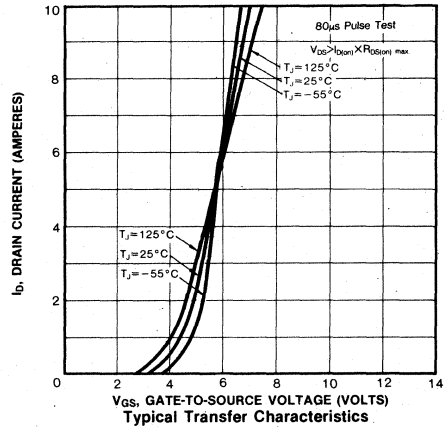
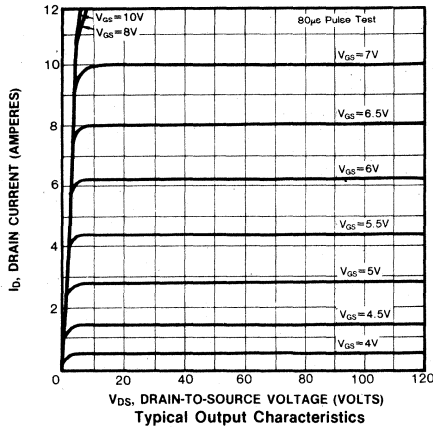

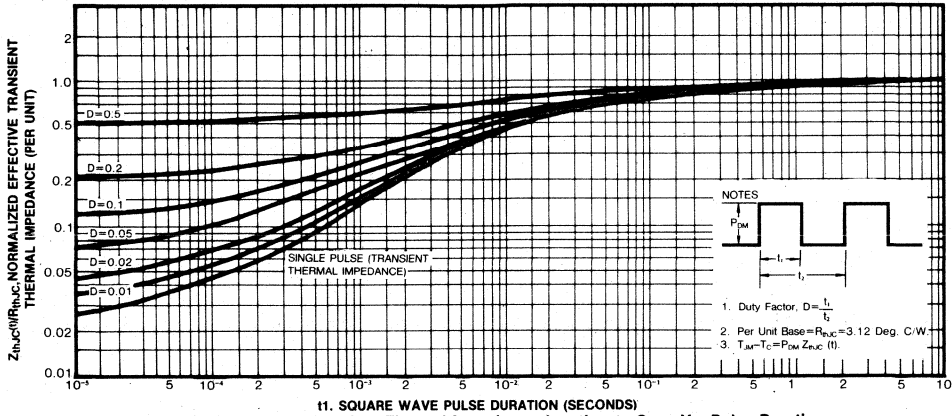

11. SQUARE WAVE PULSE DURATION (SECONDS)
Maximum Effective Transient Thermal Impedance Junction-to-Case Vs. Pulse Duration

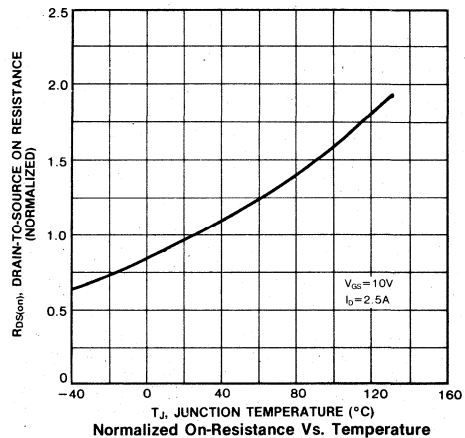
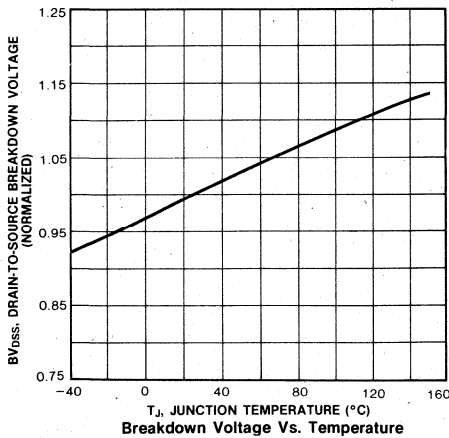
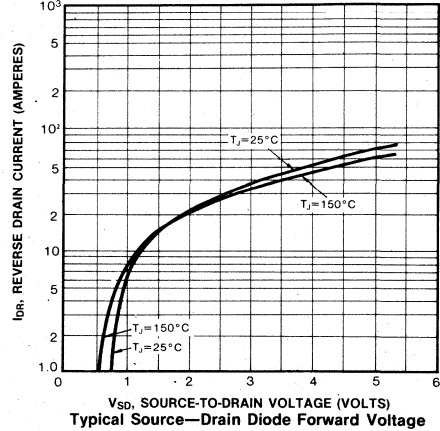
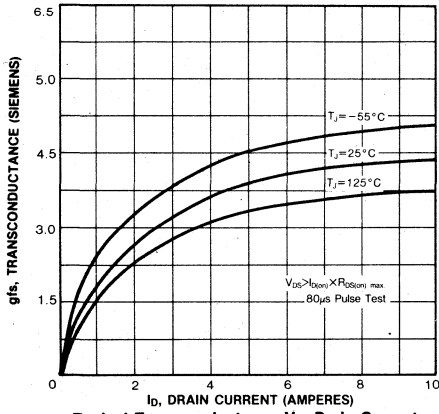

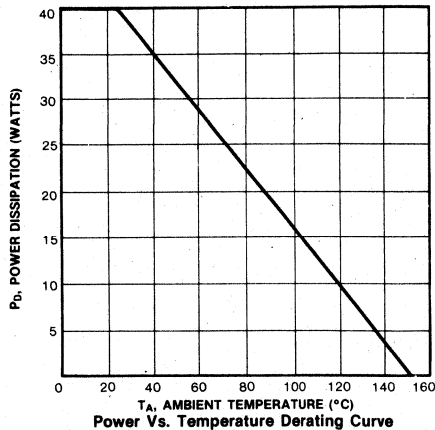
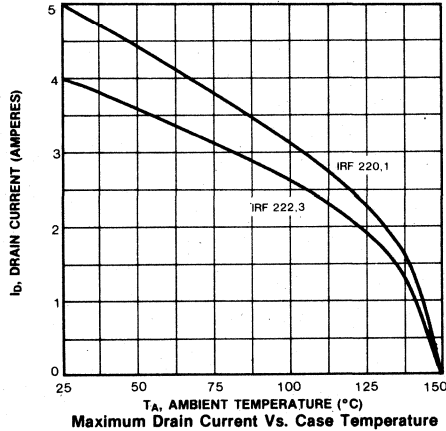
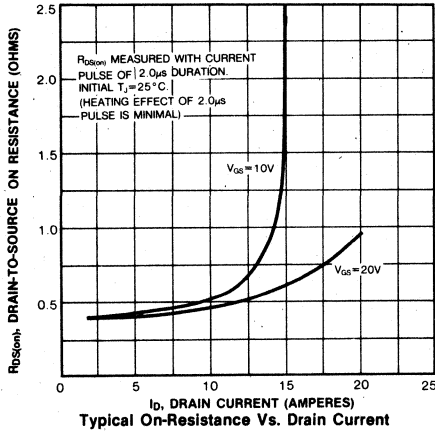
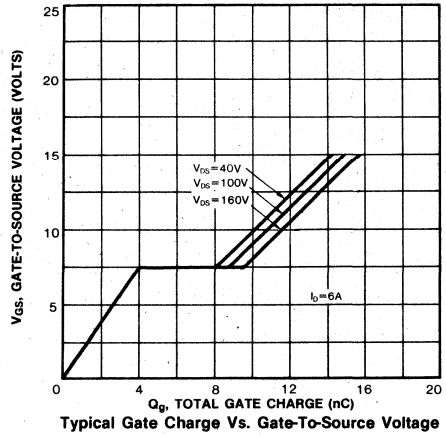
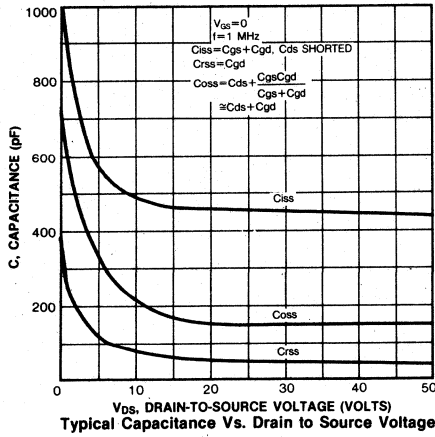

FEATURES

- Low $R_{DS(on)}$
- Improved inductive ruggedness
- Fast switching times
- Rugged polysilicon gate cell structure
- Low input capacitance
- Extended safe operating area
- Improved high temperature reliability
- TO-3 package (Standard)

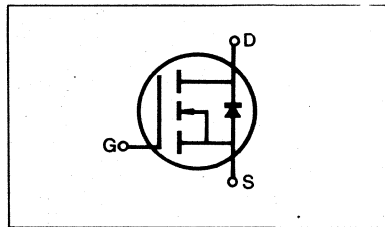
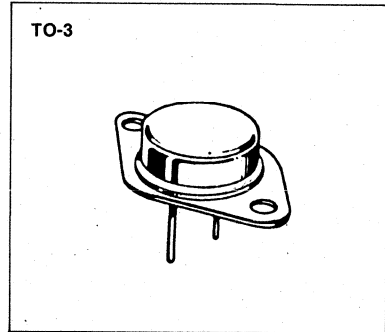

PRODUCT SUMMARY

Part Number	V_{DS}	$R_{DS(on)}$	I_D
IRF230	200V	0.4 Ω	9.0A
IRF231	150V	0.4 Ω	9.0A
IRF232	200V	0.6 Ω	8.0A
IRF233	150V	0.6 Ω	8.0A

MAXIMUM RATINGS

Characteristic	Symbol	IRF230	IRF231	IRF232	IRF233	Unit
Drain-Source Voltage (1)	V_{DSS}	200	150	200	150	Vdc
Drain-Gate Voltage ($R_{GS}=1.0M\Omega$) (1)	V_{DGR}	200	150	200	150	Vdc
Gate-Source Voltage	V_{GS}	± 20				Vdc
Continuous Drain Current $T_C=25^\circ C$	I_D	9.0	9.0	8.0	8.0	Adc
Continuous Drain Current $T_C=100^\circ C$	I_D	6.0	6.0	5.0	5.0	Adc
Drain Current—Pulsed (3)	I_{DM}	36	36	32	32	Adc
Gate Current—Pulsed	I_{GM}	± 1.5				Adc
Total Power Dissipation @ $T_C=25^\circ C$ Derate above $25^\circ C$	P_D	75 0.6				Watts W/ $^\circ C$
Operating and Storage Junction Temperature Range	T_J, T_{stg}	-55 to 150				$^\circ C$
Maximum Lead Temp. for Soldering Purposes, 1/8" from case for 5 seconds	T_L	300				$^\circ C$

- Notes: (1) $T_J=25^\circ C$ to $150^\circ C$
 (2) Pulse test: Pulse width $\leq 300\mu s$, Duty Cycle $\leq 2\%$
 (3) Repetitive rating: Pulse width limited by max. junction temperature

ELECTRICAL CHARACTERISTICS (T_C=25°C unless otherwise specified)

Characteristic	Symbol	Type	Min	Typ	Max	Units	Test Conditions
Drain-Source Breakdown Voltage	BV _{DSS}	IRF230 IRF232	200	—	—	V	V _{GS} =0V
		IRF231 IRF233	150	—	—	V	I _D =250μA
Gate Threshold Voltage	V _{GS(th)}	ALL	2.0	—	4.0	V	V _{DS} =V _{GS} , I _D =250μA
Gate-Source Leakage Forward	I _{GSS}	ALL	—	—	100	nA	V _{GS} =20V
Gate-Source Leakage Reverse	I _{GSS}	ALL	—	—	-100	nA	V _{GS} =-20V
Zero Gate Voltage Drain Current	I _{DSS}	ALL	—	—	250	μA	V _{DS} =Max. Rating, V _{GS} =0V
			—	—	1000	μA	V _{DS} =Max. Rating×0.8, V _{GS} =0V, T _C =125°C
On-State Drain-Source Current (2)	I _{D(on)}	IRF230 IRF231	9.0	—	—	A	V _{DS} >I _{D(on)} ×R _{DS(on) max.} , V _{GS} =10V
		IRF232 IRF233	8.0	—	—	A	
Static Drain-Source On-State Resistance (2)	R _{DS(on)}	IRF230 IRF231	—	0.25	0.4	Ω	V _{GS} =10V, I _D =5.0A
		IRF232 IRF233	—	0.4	0.6	Ω	
Forward Transconductance (2)	g _{fs}	ALL	3.0	4.6	—	Ω	V _{DS} >I _{D(on)} ×R _{DS(on) max.} , I _D =5.0A
Input Capacitance	C _{iss}	ALL	—	720	800	pF	V _{GS} =0V, V _{DS} =25V, f=1.0MHz
Output Capacitance	C _{oss}	ALL	—	250	450	pF	
Reverse Transfer Capacitance	C _{rss}	ALL	—	60	150	pF	
Turn-On Delay Time	t _{d(on)}	ALL	—	—	30	ns	V _{DD} =0.5BV _{DSS} , I _D =5.0A, Z _O =15 Ω (MOSFET switching times are essentially independent of operating temperature.)
Rise Time	t _r	ALL	—	—	50	ns	
Turn-Off Delay Time	t _{d(off)}	ALL	—	—	50	ns	
Fall Time	t _f	ALL	—	—	40	ns	
Total Gate Charge (Gate-Source Plus Gate-Drain)	Q _g	ALL	—	19	30	nC	V _{GS} =10V, I _D =12A, V _{DS} =0.8 Max. Rating (Gate charge is essentially independent of operating temperature.)
Gate-Source Charge	Q _{gs}	ALL	—	5.0	—	nC	
Gate-Drain ("Miller") Charge	Q _{gd}	ALL	—	14	—	nC	

THERMAL RESISTANCE

Junction-to-Case	R _{thJC}	ALL	—	—	1.67	K/W	
Case-to-Sink	R _{thCS}	ALL	—	0.1	—	K/W	Mounting surface flat, smooth, and greased
Junction-to-Ambient	R _{thJA}	ALL	—	—	30	K/W	Free Air Operation

- Notes:** (1) T_J=25°C to 150°C
(2) Pulse test: Pulse width≤300μs, Duty Cycle≤2%
(3) Repetitive rating: Pulse width limited by max. junction temperature

SOURCE-DRAIN DIODE RATINGS AND CHARACTERISTICS

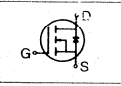
Characteristic	Symbol	Type	Min	Typ	Max	Units	Test Conditions
Continuous Source Current (Body Diode)	I_S	IRF230	—	—	9.0	A	Modified MOSFET symbol showing the integral reverse P-N junction rectifier 
		IRF231	—	—	9.0	A	
		IRF232	—	—	8.0	A	
Pulse Source Current (Body Diode) (3)	I_{SM}	IRF230	—	—	36	A	
		IRF231	—	—	36	A	
		IRF233	—	—	32	A	
Diode Forward Voltage (2)	V_{SD}	IRF230	—	—	2.0	V	$T_C=25^\circ\text{C}$, $I_S=9.0\text{A}$, $V_{GS}=0\text{V}$
		IRF231	—	—	2.0	V	$T_C=25^\circ\text{C}$, $I_S=9.0\text{A}$, $V_{GS}=0\text{V}$
		IRF233	—	—	1.8	V	$T_C=25^\circ\text{C}$, $I_S=8.0\text{A}$, $V_{GS}=0\text{V}$
Reverse Recovery Time	t_{rr}	ALL	—	450	—	ns	$T_J=150^\circ\text{C}$, $I_F=9.0\text{A}$, $dI_F/dt=100\text{A}/\mu\text{s}$

Notes: (1) $T_J=25^\circ\text{C}$ to 150°C (2) Pulse test: Pulse width $\leq 300\mu\text{s}$, Duty Cycle $\leq 2\%$
 (3) Repetitive rating: Pulse width limited by max. junction temperature

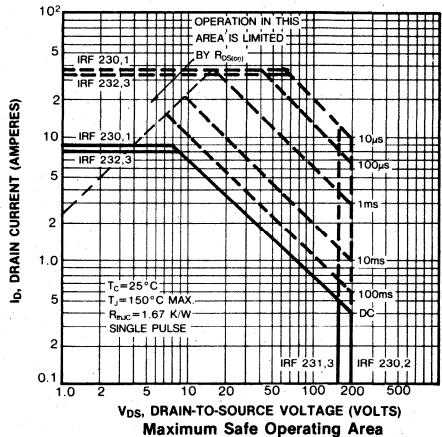
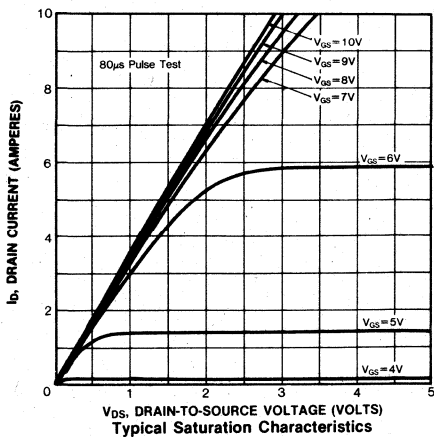
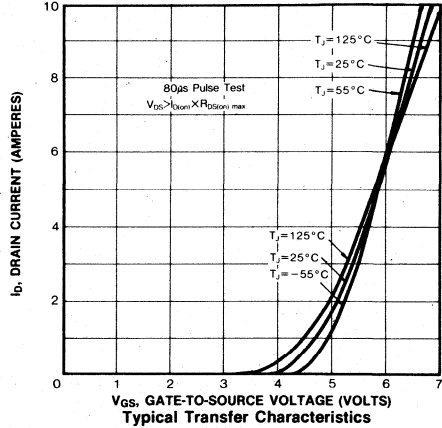
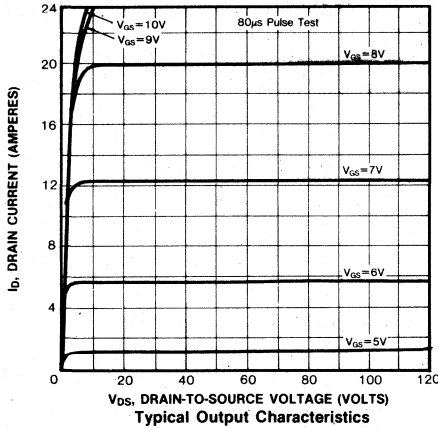

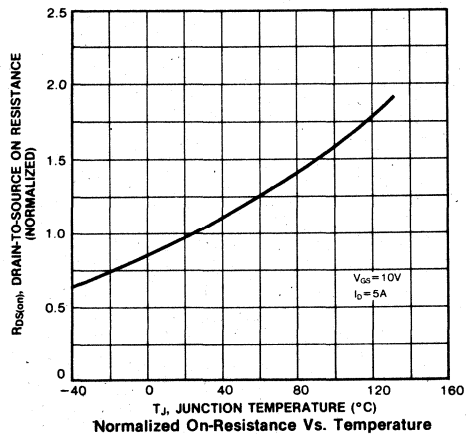
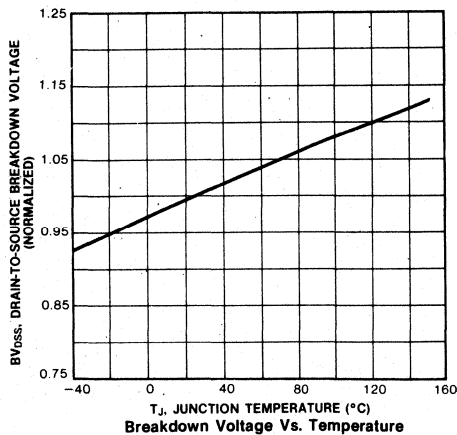
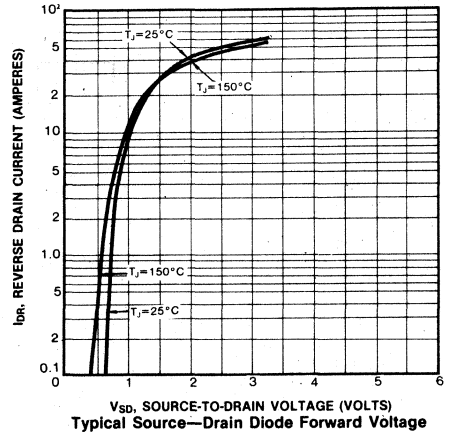
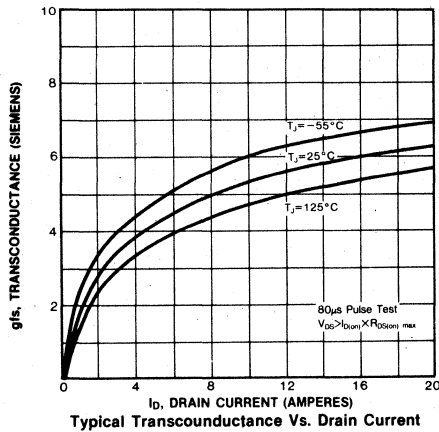
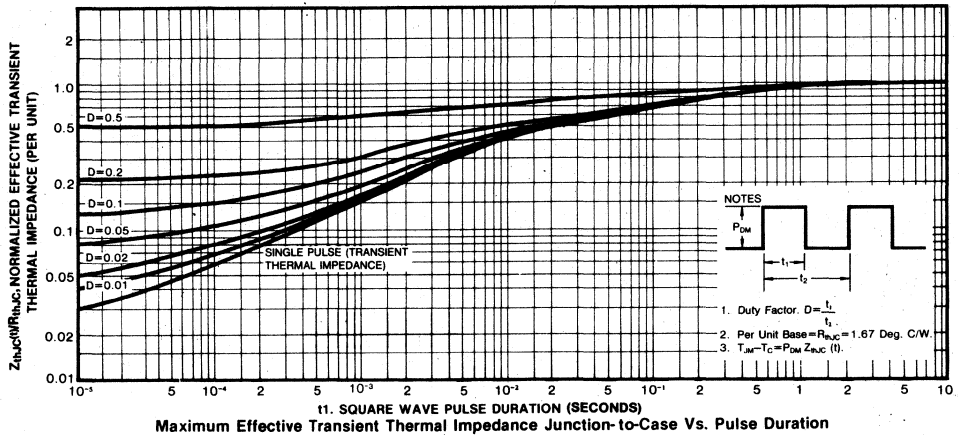

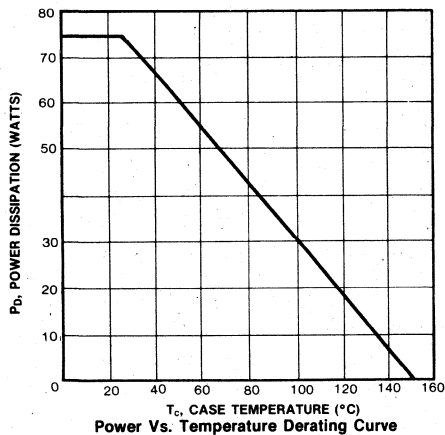
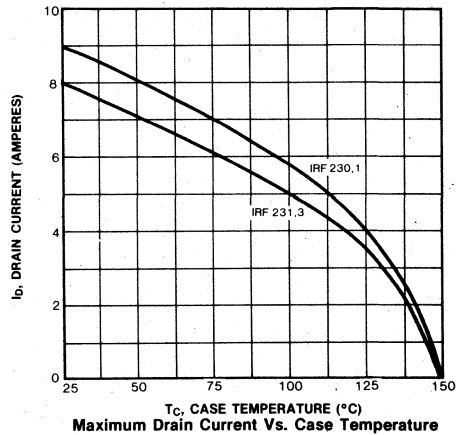
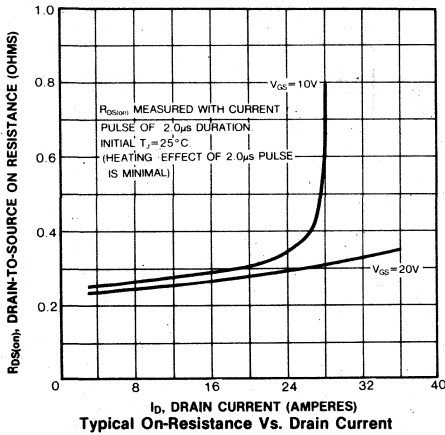
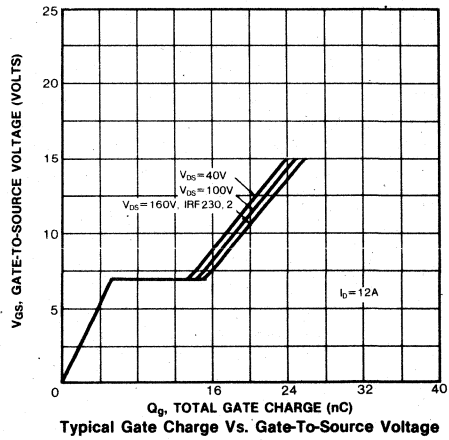
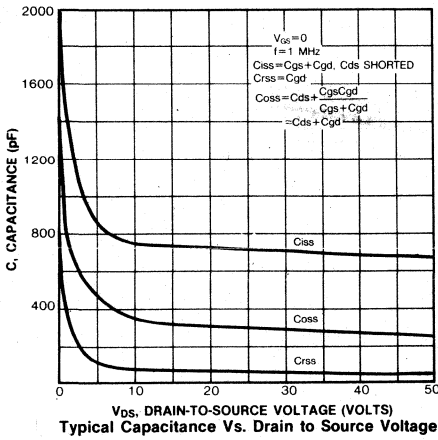

4

FEATURES

- Low $R_{DS(on)}$
- Improved inductive ruggedness
- Fast switching times
- Rugged polysilicon gate cell structure
- Low input capacitance
- Extended safe operating area
- Improved high temperature reliability
- TO-3 package (Standard)

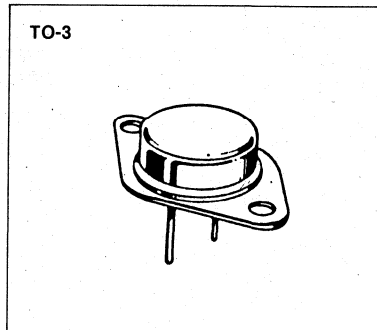

PRODUCT SUMMARY

Part Number	V_{DS}	$R_{DS(on)}$	I_D
IRF240	200V	0.18 Ω	18A
IRF241	150V	0.18 Ω	18A
IRF242	200V	0.22 Ω	16A
IRF243	150V	0.22 Ω	16A

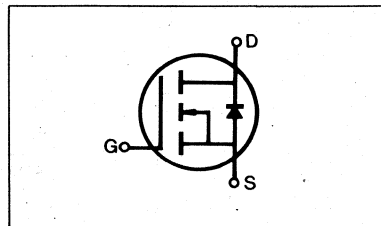

MAXIMUM RATINGS

Characteristic	Symbol	IRF240	IRF241	IRF242	IRF243	Unit
Drain-Source Voltage (1)	V_{DSS}	200	150	200	150	Vdc
Drain-Gate Voltage ($R_{GS} = 1.0M\Omega$) (1)	V_{DGR}	200	150	200	150	Vdc
Gate-Source Voltage	V_{GS}	± 20				Vdc
Continuous Drain Current $T_C = 25^\circ C$	I_D	18	18	16	16	Adc
Continuous Drain Current $T_C = 100^\circ C$	I_D	11	11	10	10	Adc
Drain Current—Pulsed (3)	I_{DM}	72	72	64	64	Adc
Gate Current—Pulsed	I_{GM}	± 1.5				Adc
Total Power Dissipation @ $T_C = 25^\circ C$ Derate above $25^\circ C$	P_D	125 1.0				Watts W/ $^\circ C$
Operating and Storage Junction Temperature Range	T_J, T_{stg}	-55 to 150				$^\circ C$
Maximum Lead Temp. for Soldering Purposes, 1/8" from case for 5 seconds	T_L	300				$^\circ C$

- Notes:** (1) $T_J = 25^\circ C$ to $150^\circ C$
 (2) Pulse test: Pulse width $\leq 300\mu s$, Duty Cycle $\leq 2\%$
 (3) Repetitive rating: Pulse width limited by max. junction temperature

ELECTRICAL CHARACTERISTICS (T_C=25 °C unless otherwise specified)

Characteristic	Symbol	Type	Min	Typ	Max	Units	Test Conditions
Drain-Source Breakdown Voltage	BV _{DSS}	IRF240 IRF242	200	—	—	V	V _{GS} =0V
		IRF241 IRF243	150	—	—	V	I _D =250μA
Gate Threshold Voltage	V _{GS(th)}	ALL	2.0	—	4.0	V	V _{DS} =V _{GS} , I _D =250μA
Gate-Source Leakage Forward	I _{GSS}	ALL	—	—	100	nA	V _{GS} =20V
Gate-Source Leakage Reverse	I _{GSS}	ALL	—	—	-100	nA	V _{GS} =-20V
Zero Gate Voltage Drain Current	I _{DSS}	ALL	—	—	250	μA	V _{DS} =Max. Rating, V _{GS} =0V
			—	—	1000	μA	V _{DS} =Max. Rating×0.8, V _{GS} =0V, T _C =125 °C
On-State Drain-Source Current (2)	I _{D(on)}	IRF240 IRF241	18	—	—	A	V _{DS} >I _{D(on)} ×R _{DS(on)} max., V _{GS} =10V
		IRF242 IRF243	16	—	—	A	
Static Drain-Source On-State Resistance (2)	R _{DS(on)}	IRF240 IRF241	—	0.13	0.18	Ω	V _{GS} =10V, I _D =10A
		IRF242 IRF243	—	0.20	0.22	Ω	
Forward Transconductance (2)	g _{fs}	ALL	6.0	9.5	—	Ω	V _{DS} >I _{D(on)} ×R _{DS(on)} max., I _D =10A
Input Capacitance	C _{iss}	ALL	—	1200	1600	pF	V _{GS} =0V, V _{DS} =25V, f=1.0MHz
Output Capacitance	C _{oss}	ALL	—	360	750	pF	
Reverse Transfer Capacitance	C _{rss}	ALL	—	130	300	pF	
Turn-On Delay Time	t _{d(on)}	ALL	—	—	30	ns	V _{DD} =0.5BV _{DSS} , I _D =10A, Z _O =4.7 Ω (MOSFET switching times are essentially independent of operating temperature.)
Rise Time	t _r	ALL	—	—	60	ns	
Turn-Off Delay Time	t _{d(off)}	ALL	—	—	80	ns	
Fall Time	t _f	ALL	—	—	60	ns	
Total Gate Charge (Gate-Source Plus Gate-Drain)	Q _g	ALL	—	44	60	nC	V _{GS} =10V, I _D =22A, V _{DS} =0.8 Max. Rating (Gate charge is essentially independent of operating temperature.)
Gate-Source Charge	Q _{gs}	ALL	—	9	—	nC	
Gate-Drain ("Miller") Charge	Q _{gd}	ALL	—	35	—	nC	

THERMAL RESISTANCE

Junction-to-Case	R _{thJC}	ALL	—	—	1.0	K/W	
Case-to-Sink	R _{thCS}	ALL	—	0.1	—	K/W	Mounting surface flat, smooth, and greased
Junction-to-Ambient	R _{thJA}	ALL	—	—	30	K/W	Free Air Operation

- Notes:** (1) T_J=25 °C to 150 °C
 (2) Pulse test: Pulse width≤300μs, Duty Cycle≤2%
 (3) Repetitive rating: Pulse width limited by max. junction temperature

SOURCE-DRAIN DIODE RATINGS AND CHARACTERISTICS

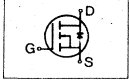
Characteristic	Symbol	Type	Min	Typ	Max	Units	Test Conditions
Continuous Source Current (Body Diode)	I_S	IRF240 IRF241	—	—	18	A	Modified MOSFET symbol showing the integral reverse P-N junction rectifier 
		IRF242 IRF243	—	—	16	A	
Pulse Source Current (Body Diode) (3)	I_{SM}	IRF240 IRF241	—	—	72	A	
		IRF242 IRF243	—	—	64	A	
Diode Forward Voltage (2)	V_{SD}	IRF240 IRF241	—	—	2.0	V	$T_C=25^\circ\text{C}$, $I_S=18\text{A}$, $V_{GS}=0\text{V}$
		IRF242 IRF243	—	—	1.9	V	$T_C=25^\circ\text{C}$, $I_S=16\text{A}$, $V_{GS}=0\text{V}$
Reverse Recovery Time	t_{rr}	ALL	—	650	—	ns	$T_J=150^\circ\text{C}$, $I_F=18\text{A}$, $dI_F/dt=100\text{A}/\mu\text{s}$

Notes: (1) $T_J=25^\circ\text{C}$ to 150°C (2) Pulse test: Pulse width $\leq 300\mu\text{s}$, Duty Cycle $\leq 2\%$
 (3) Repetitive rating: Pulse width limited by max. junction temperature

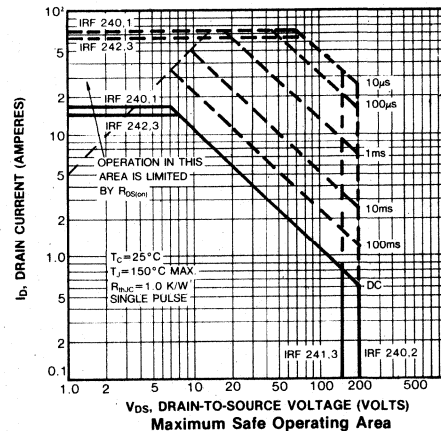
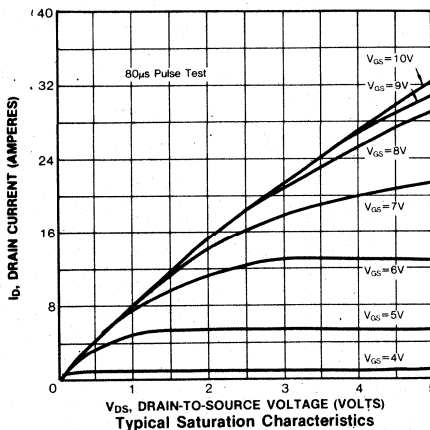
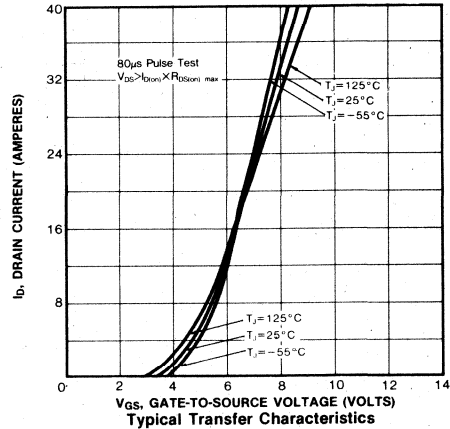
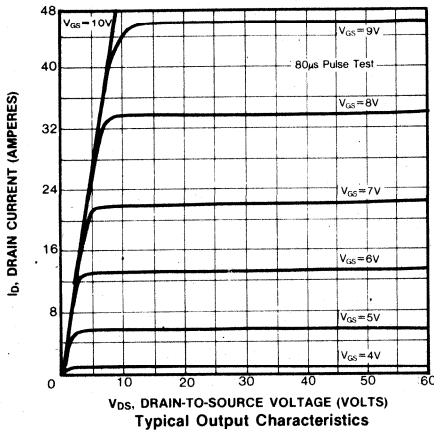

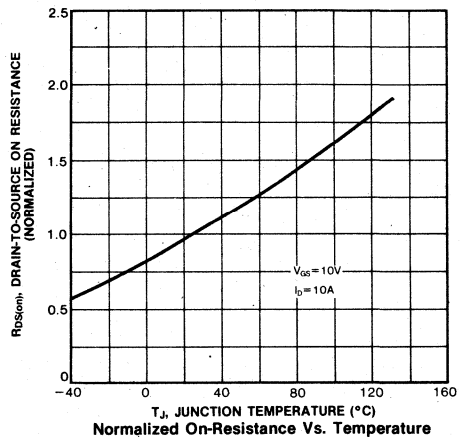
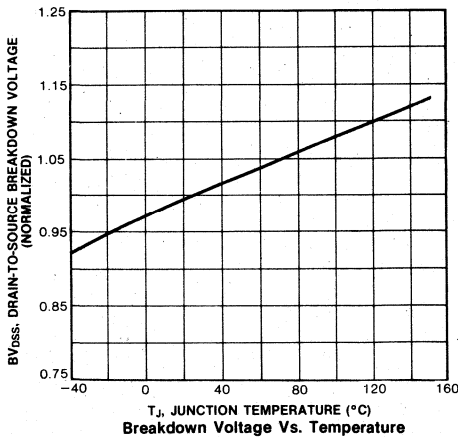
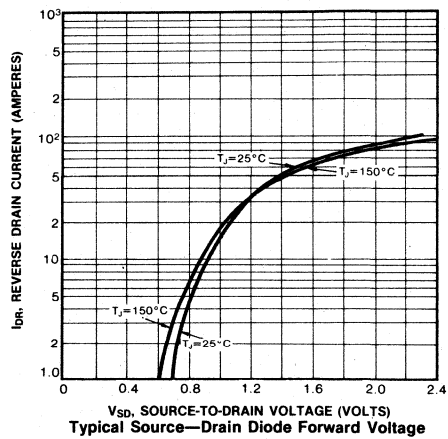
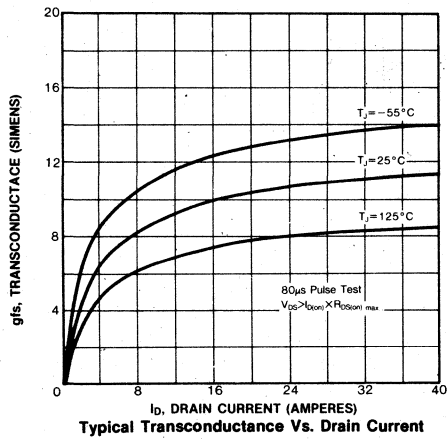
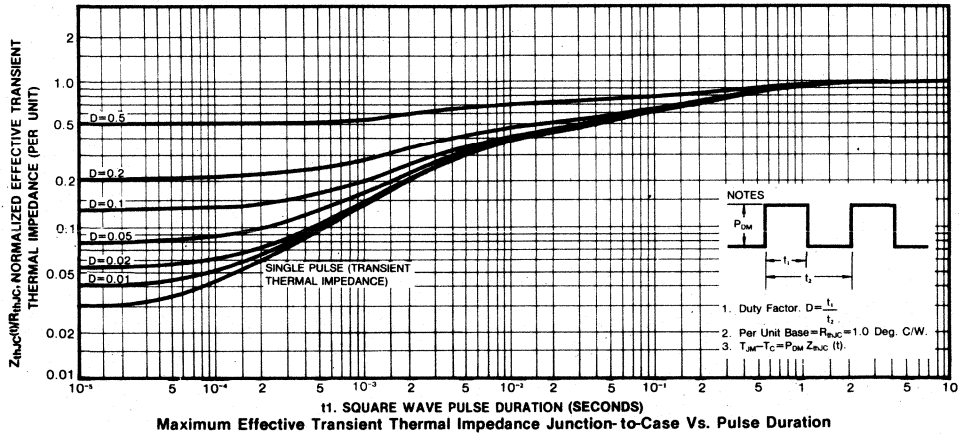

IRF240/241/242/243

N-CHANNEL POWER MOSFETS

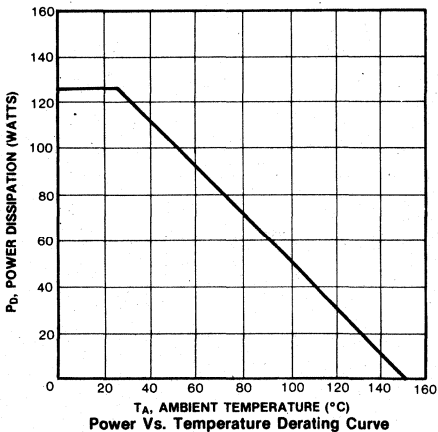
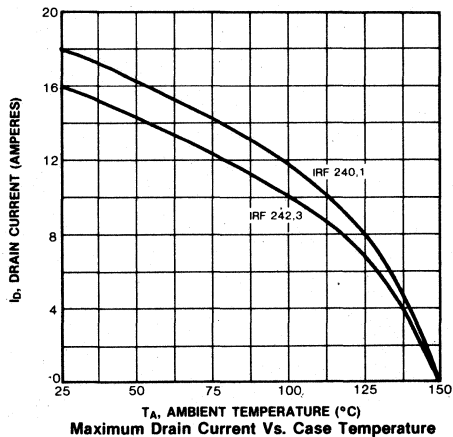
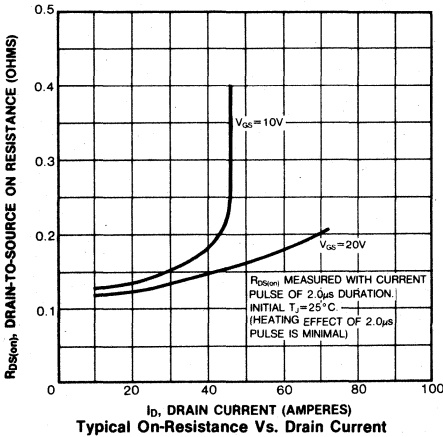
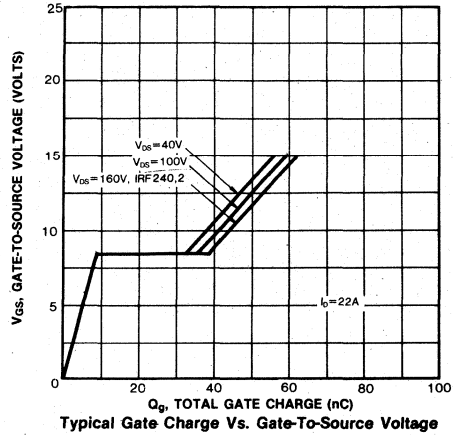
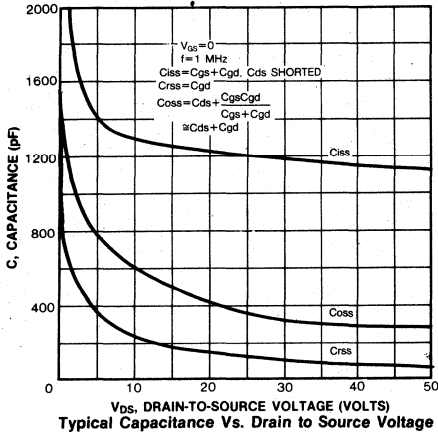

FEATURES

- Low $R_{DS(on)}$
- Improved inductive ruggedness
- Fast switching times
- Rugged polysilicon gate cell structure
- Low input capacitance
- Extended safe operating area
- Improved high temperature reliability
- TO-3 package (High current)

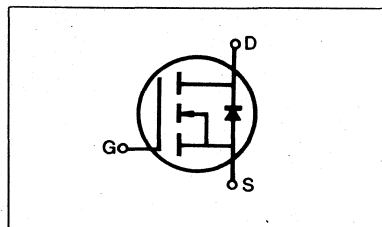
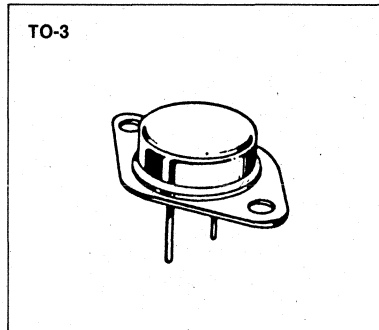

PRODUCT SUMMARY

Part Number	V_{DS}	$R_{DS(on)}$	I_D
IRF250	200V	0.085 Ω	30A
IRF251	150V	0.085 Ω	30A
IRF252	200V	0.12 Ω	25A
IRF253	150V	0.12 Ω	25A

MAXIMUM RATINGS

Characteristic	Symbol	IRF250	IRF251	IRF252	IRF253	Unit
Drain-Source Voltage (1)	V_{DSS}	200	150	200	150	Vdc
Drain-Gate Voltage ($R_{GS}=1.0M\Omega$) (1)	V_{DGR}	200	150	200	150	Vdc
Gate-Source Voltage	V_{GS}	± 20				Vdc
Continuous Drain Current $T_C=25^\circ C$	I_D	30	30	25	25	Adc
Continuous Drain Current $T_C=100^\circ C$	I_D	19	19	16	16	Adc
Drain Current—Pulsed (3)	I_{DM}	120	120	100	100	Adc
Gate Current—Pulsed	I_{GM}	± 1.5				Adc
Total Power Dissipation @ $T_C=25^\circ C$ Derate above $25^\circ C$	P_D	150 1.2				Watts W/ $^\circ C$
Operating and Storage Junction Temperature Range	T_J, T_{stg}	-55 to 150				$^\circ C$
Maximum Lead Temp. for Soldering Purposes, 1/8" from case for 5 seconds	T_L	300				$^\circ C$

- Notes: (1) $T_J=25^\circ C$ to $150^\circ C$
 (2) Pulse test: Pulse width $\leq 300\mu s$, Duty Cycle $\leq 2\%$
 (3) Repetitive rating: Pulse width limited by max. junction temperature

ELECTRICAL CHARACTERISTICS (T_C=25°C unless otherwise specified)

Characteristic	Symbol	Type	Min	Typ	Max	Units	Test Conditions
Drain-Source Breakdown Voltage	BV _{DSS}	IRF250 IRF252	200	—	—	V	V _{GS} =0V
		IRF251 IRF253	150	—	—	V	I _D =250μA
Gate Threshold Voltage	V _{GS(th)}	ALL	2.0	—	4.0	V	V _{DS} =V _{GS} , I _D =250μA
Gate-Source Leakage Forward	I _{GSS}	ALL	—	—	100	nA	V _{GS} =20V
Gate-Source Leakage Reverse	I _{GSS}	ALL	—	—	-100	nA	V _{GS} =-20V
Zero Gate Voltage Drain Current	I _{DSS}	ALL	—	—	250	μA	V _{DS} =Max. Rating, V _{GS} =0V
			—	—	1000	μA	V _{DS} =Max. Rating×0.8, V _{GS} =0V, T _C =125°C
On-State Drain-Source Current (2)	I _{D(on)}	IRF250 IRF251	30	—	—	A	V _{DS} >I _{D(on)} ×R _{DS(on) max.} , V _{GS} =10V
		IRF252 IRF253	25	—	—	A	
Static Drain-Source On-State Resistance (2)	R _{DS(on)}	IRF250 IRF251	—	0.07	0.085	Ω	V _{GS} =10V, I _D =16A
		IRF252 IRF253	—	0.09	0.120	Ω	
Forward Transconductance (2)	g _{fs}	ALL	8.0	12.5	—	Ω	V _{DS} >I _{D(on)} ×R _{DS(on) max.} , I _D =16A
Input Capacitance	C _{iss}	ALL	—	2640	3000	pF	V _{GS} =0V, V _{DS} =25V, f=1.0MHz
Output Capacitance	C _{oss}	ALL	—	800	1200	pF	
Reverse Transfer Capacitance	C _{rss}	ALL	—	300	500	pF	
Turn-On Delay Time	t _{d(on)}	ALL	—	—	35	ns	V _{DD} =0.5BV _{DSS} , I _D =16A, Z _O =4.7 Ω (MOSFET switching times are essentially independent of operating temperature.)
Rise Time	t _r	ALL	—	—	100	ns	
Turn-Off Delay Time	t _{d(off)}	ALL	—	—	125	ns	
Fall Time	t _f	ALL	—	—	100	ns	
Total Gate Charge (Gate-Source Plus Gate-Drain)	Q _g	ALL	—	68	120	nC	V _{GS} =10V, I _D =38A, V _{DS} =0.8 Max. Rating (Gate charge is essentially independent of operating temperature.)
Gate-Source Charge	Q _{gs}	ALL	—	18	—	nC	
Gate-Drain ("Miller") Charge	Q _{gd}	ALL	—	50	—	nC	

THERMAL RESISTANCE

Junction-to-Case	R _{thJC}	ALL	—	—	0.83	K/W	
Case-to-Sink	R _{thCS}	ALL	—	0.1	—	K/W	Mounting surface flat, smooth, and greased
Junction-to-Ambient	R _{thJA}	ALL	—	—	30	K/W	Free Air Operation

- Notes:** (1) T_J=25°C to 150°C
 (2) Pulse test: Pulse width<300μs, Duty Cycle<2%
 (3) Repetitive rating: Pulse width limited by max. junction temperature

SOURCE-DRAIN DIODE RATINGS AND CHARACTERISTICS

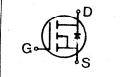
Characteristic	Symbol	Type	Min	Typ	Max	Units	Test Conditions
Continuous Source Current (Body Diode)	I_S	IRF250	—	—	30	A	Modified MOSFET symbol showing the integral reverse P-N junction rectifier 
		IRF251	—	—	30	A	
		IRF252	—	—	25	A	
Pulse Source Current (Body Diode) (3)	I_{SM}	IRF250	—	—	120	A	
		IRF251	—	—	120	A	
		IRF252	—	—	100	A	
Diode Forward Voltage (2)	V_{SD}	IRF250	—	—	2.0	V	$T_C=25^\circ\text{C}$, $I_S=30\text{A}$, $V_{GS}=0\text{V}$
		IRF251	—	—	2.0	V	$T_C=25^\circ\text{C}$, $I_S=30\text{A}$, $V_{GS}=0\text{V}$
		IRF252	—	—	1.8	V	$T_C=25^\circ\text{C}$, $I_S=25\text{A}$, $V_{GS}=0\text{V}$
Reverse Recovery Time	t_{rr}	ALL	—	750	—	ns	$T_J=150^\circ\text{C}$, $I_F=30\text{A}$, $dI_F/dt=100\text{A}/\mu\text{s}$

Notes: (1) $T_J=25^\circ\text{C}$ to 150°C (2) Pulse test: Pulse width $\leq 300\mu\text{s}$, Duty Cycle $\leq 2\%$
 (3) Repetitive rating: Pulse width limited by max. junction temperature

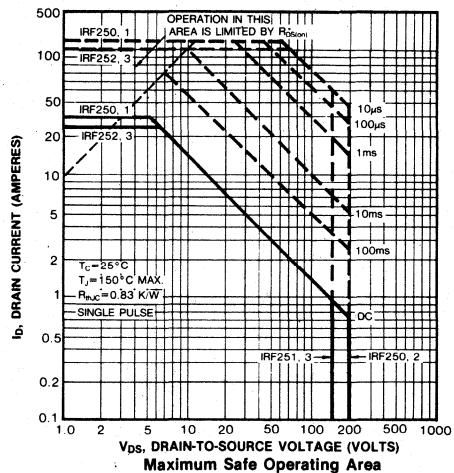
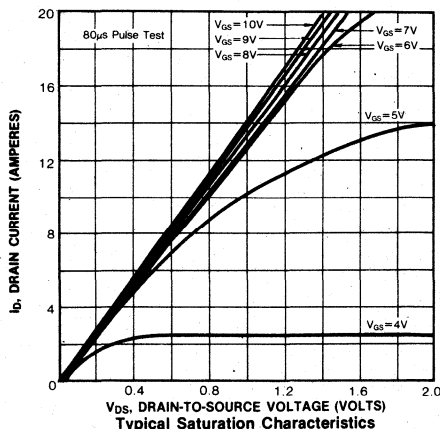
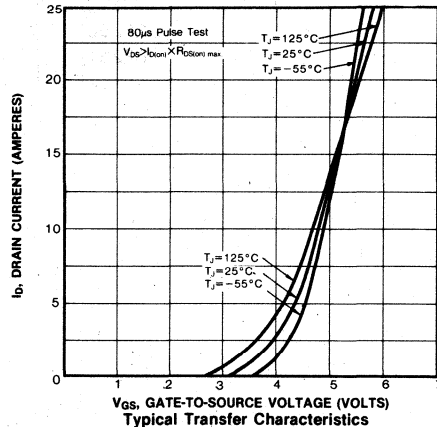
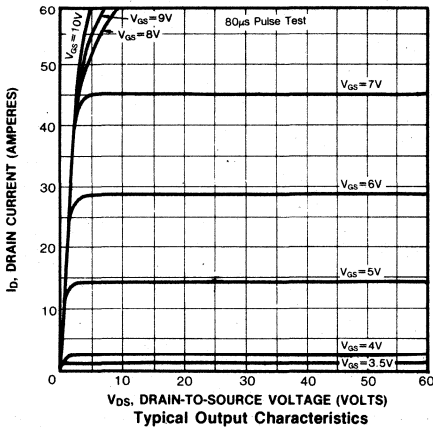

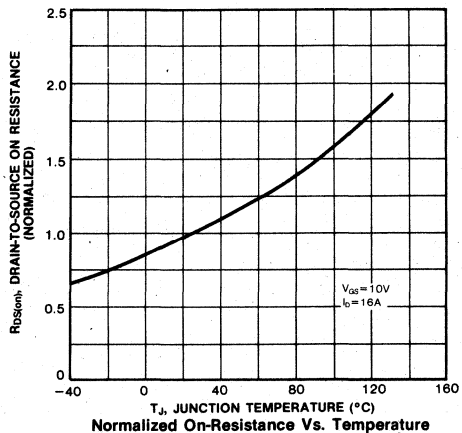
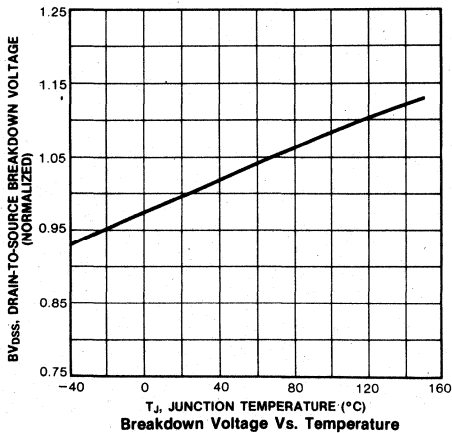
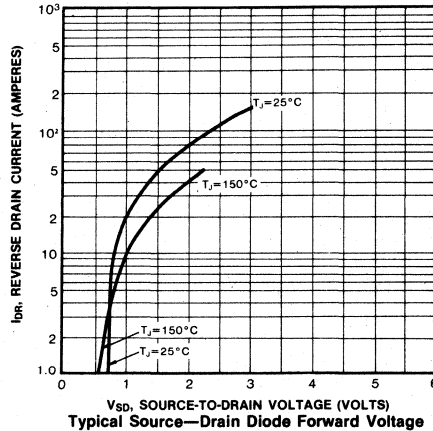
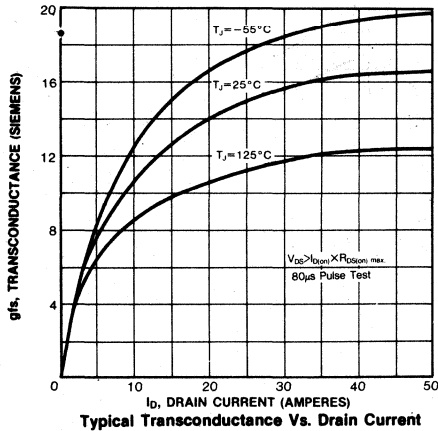
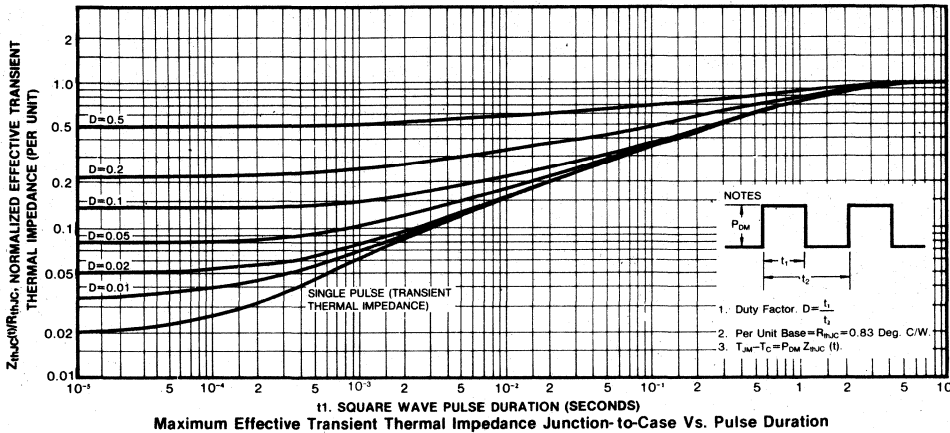

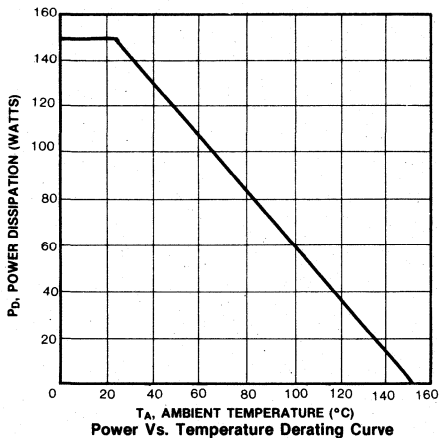
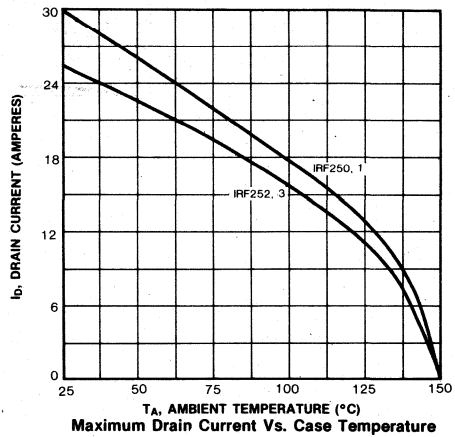
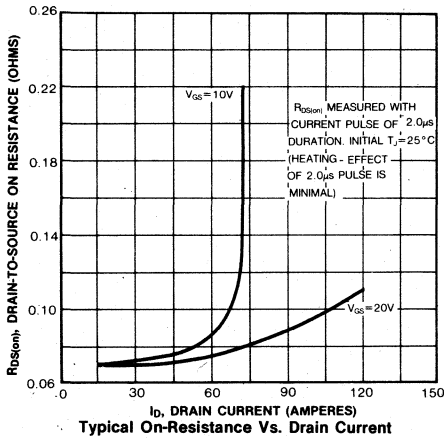
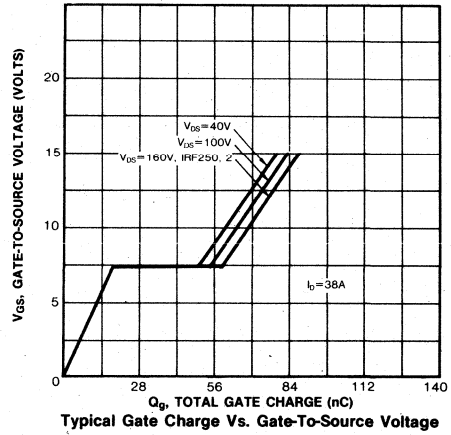
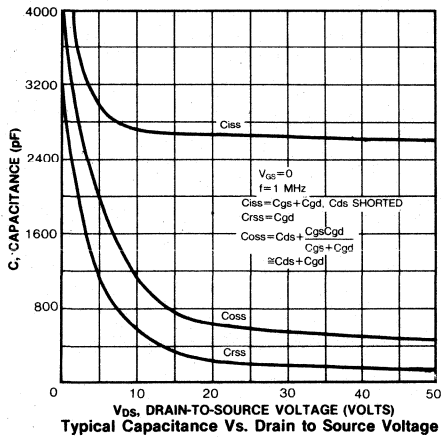

4

FEATURES

- Low $R_{DS(on)}$
- Improved inductive ruggedness
- Fast switching times
- Rugged polysilicon gate cell structure
- Low input capacitance
- Extended safe operating area
- Improved high temperature reliability
- TO-3 package (Standard)

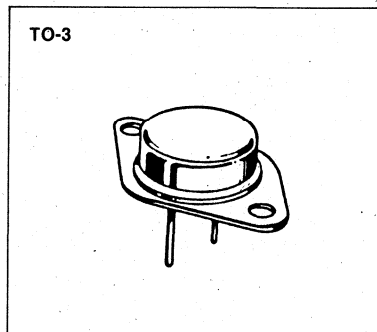

PRODUCT SUMMARY

Part Number	V_{DS}	$R_{DS(on)}$	I_D
IRF320	400V	1.8 Ω	3.0A
IRF321	350V	1.8 Ω	3.0A
IRF322	400V	2.5 Ω	2.5A
IRF323	350V	2.5 Ω	2.5A

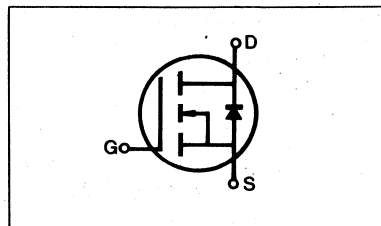

MAXIMUM RATINGS

Characteristic	Symbol	IRF320	IRF321	IRF322	IRF323	Unit
Drain-Source Voltage (1)	V_{DSS}	400	350	400	350	Vdc
Drain-Gate Voltage ($R_{GS}=1.0M\Omega$) (1)	V_{DGR}	400	350	400	350	Vdc
Gate-Source Voltage	V_{GS}	± 20				Vdc
Continuous Drain Current $T_C=25^\circ C$	I_D	3.0	3.0	2.5	2.5	Adc
Continuous Drain Current $T_C=100^\circ C$	I_D	2.0	2.0	1.5	1.5	Adc
Drain Current—Pulsed (3)	I_{DM}	12	12	10	10	Adc
Gate Current—Pulsed	I_{GM}	± 1.5				Adc
Total Power Dissipation @ $T_C=25^\circ C$ Derate above $25^\circ C$	P_D	40 0.32				Watts W/ $^\circ C$
Operating and Storage Junction Temperature Range	T_J, T_{stg}	-55 to 150				$^\circ C$
Maximum Lead Temp. for Soldering Purposes, 1/8" from case for 5 seconds	T_L	300				$^\circ C$

Notes: (1) $T_J=25^\circ C$ to $150^\circ C$

(2) Pulse test: Pulse width $\leq 300\mu s$, Duty Cycle $\leq 2\%$

(3) Repetitive rating: Pulse width limited by max. junction temperature

ELECTRICAL CHARACTERISTICS (T_C=25°C unless otherwise specified)

Characteristic	Symbol	Type	Min	Typ	Max	Units	Test Conditions
Drain-Source Breakdown Voltage	BV _{DSS}	IRF320 IRF322	400	—	—	V	V _{GS} =0V
		IRF321 IRF323	350	—	—	V	I _D =250μA
Gate Threshold Voltage	V _{GS(th)}	ALL	2.0	—	4.0	V	V _{DS} =V _{GS} , I _D =250μA
Gate-Source Leakage Forward	I _{GSS}	ALL	—	—	100	nA	V _{GS} =20V
Gate-Source Leakage Reverse	I _{GSS}	ALL	—	—	-100	nA	V _{GS} =-20V
Zero Gate Voltage Drain Current	I _{DSS}	ALL	—	—	250	μA	V _{DS} =Max. Rating, V _{GS} =0V
			—	—	1000	μA	V _{DS} =Max. Rating×0.8, V _{GS} =0V, T _C =125°C
On-State Drain-Source Current (2)	I _{D(on)}	IRF320 IRF321	3.0	—	—	A	V _{DS} >I _{D(on)} ×R _{DS(on)} max., V _{GS} =10V
		IRF322 IRF323	2.5	—	—	A	
Static Drain-Source On-State Resistance (2)	R _{DS(on)}	IRF320 IRF321	—	1.4	1.8	Ω	V _{GS} =10V, I _D =1.5A
		IRF322 IRF323	—	1.7	2.5	Ω	
Forward Transconductance (2)	g _{fs}	ALL	1.0	2.2	—	Ω	V _{DS} >I _{D(on)} ×R _{DS(on)} max., I _D =1.5A
Input Capacitance	C _{iss}	ALL	—	460	600	pF	V _{GS} =0V, V _{DS} =25V, f=1.0MHz
Output Capacitance	C _{oss}	ALL	—	90	200	pF	
Reverse Transfer Capacitance	C _{rss}	ALL	—	30	40	pF	
Turn-On Delay Time	t _{d(on)}	ALL	—	—	40	ns	V _{DD} =0.5BV _{DSS} , I _D =1.5A, Z _O =50 Ω (MOSFET switching times are essentially independent of operating temperature.)
Rise Time	t _r	ALL	—	—	50	ns	
Turn-Off Delay Time	t _{d(off)}	ALL	—	—	100	ns	
Fall Time	t _f	ALL	—	—	50	ns	
Total Gate Charge (Gate-Source Plus Gate-Drain)	Q _g	ALL	—	12.5	15	nC	V _{GS} =10V, I _D =4.0A, V _{DS} =0.8 Max. Rating (Gate charge is essentially independent of operating temperature.)
Gate-Source Charge	Q _{gs}	ALL	—	2.8	—	nC	
Gate-Drain ("Miller") Charge	Q _{gd}	ALL	—	9.7	—	nC	

4

THERMAL RESISTANCE

Junction-to-Case	R _{thJC}	ALL	—	—	3.12	K/W	
Case-to-Sink	R _{thCS}	ALL	—	0.1	—	K/W	Mounting surface flat, smooth, and greased
Junction-to-Ambient	R _{thJA}	ALL	—	—	30	K/W	Free Air Operation

- Notes:** (1) T_J=25°C to 150°C
 (2) Pulse test: Pulse width≤300μs, Duty Cycle≤2%
 (3) Repetitive rating: Pulse width limited by max. junction temperature

SOURCE-DRAIN DIODE RATINGS AND CHARACTERISTICS

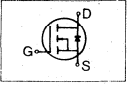
Characteristic	Symbol	Type	Min	Typ	Max	Units	Test Conditions
Continuous Source Current (Body Diode)	I_S	IRF320	—	—	3.0	A	Modified MOSFET symbol showing the integral reverse P-N junction rectifier 
		IRF321	—	—	2.5	A	
Pulse Source Current (Body Diode) (3)	I_{SM}	IRF320	—	—	12	A	
		IRF321	—	—	10	A	
Diode Forward Voltage (2)	V_{SD}	IRF320	—	—	1.6	V	$T_C=25^\circ\text{C}$, $I_S=3.0\text{A}$, $V_{GS}=0\text{V}$
		IRF321	—	—	1.5	V	$T_C=25^\circ\text{C}$, $I_S=2.5\text{A}$, $V_{GS}=0\text{V}$
Reverse Recovery Time	t_{rr}	ALL	—	450	—	ns	$T_J=150^\circ\text{C}$, $I_F=3.0\text{A}$, $di/dt=100\text{A}/\mu\text{s}$

Notes: (1) $T_J=25^\circ\text{C}$ to 150°C (2) Pulse test: Pulse width $\leq 300\mu\text{s}$, Duty Cycle $\leq 2\%$
 (3) Repetitive rating: Pulse width limited by max. junction temperature

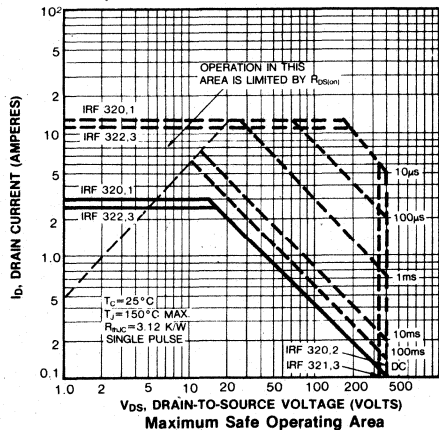
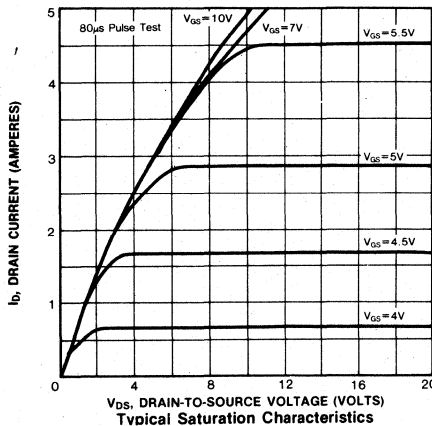
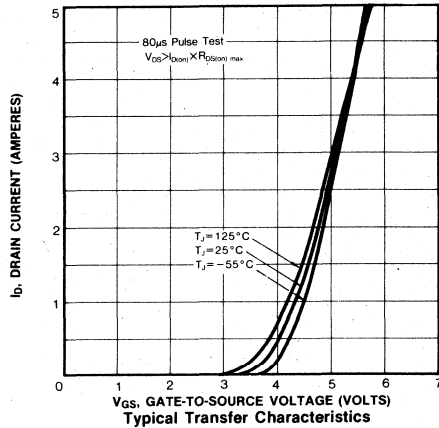
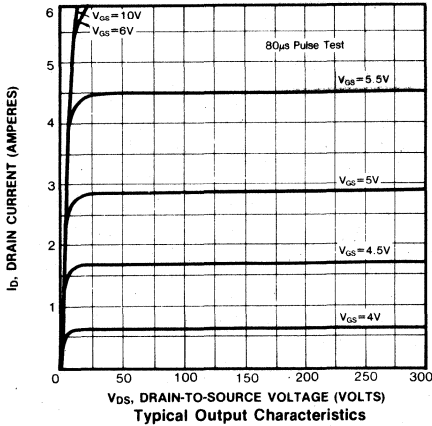

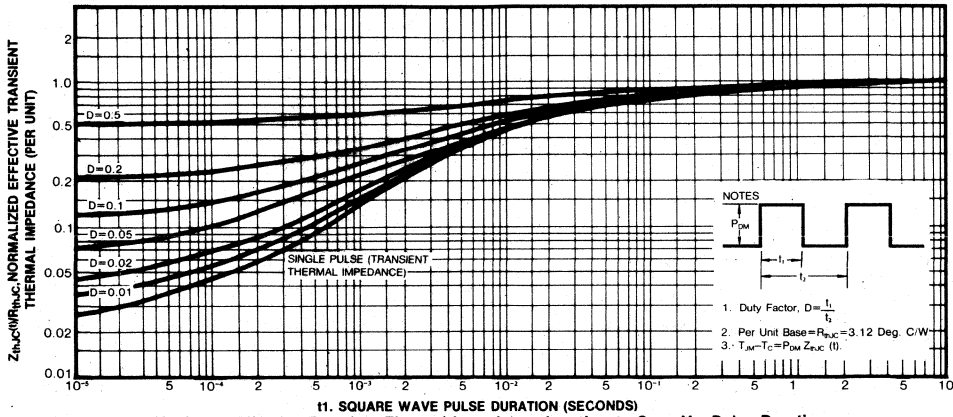

11. SQUARE WAVE PULSE DURATION (SECONDS)
Maximum Effective Transient Thermal Impedance Junction-to-Case Vs. Pulse Duration

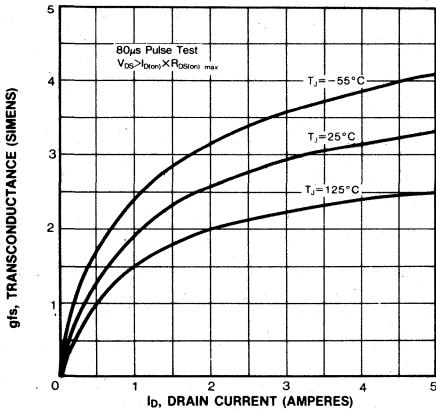

Typical Transconductance Vs. Drain Current

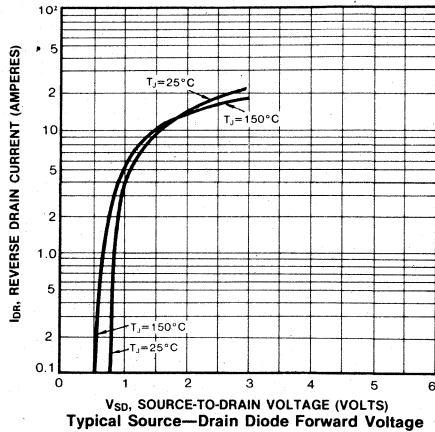

Typical Source-Drain Diode Forward Voltage

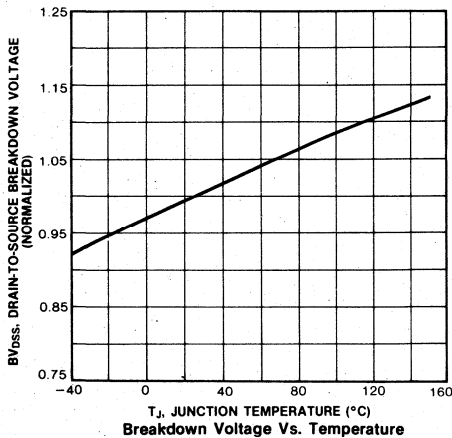

Breakdown Voltage Vs. Temperature

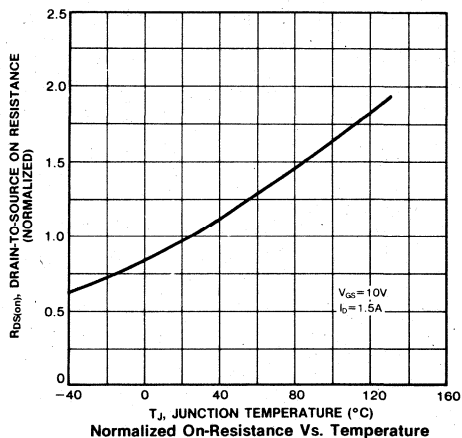

Normalized On-Resistance Vs. Temperature

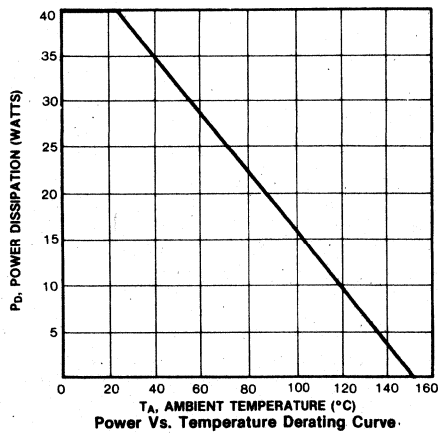
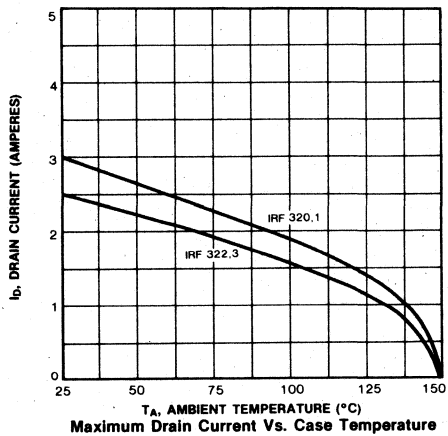
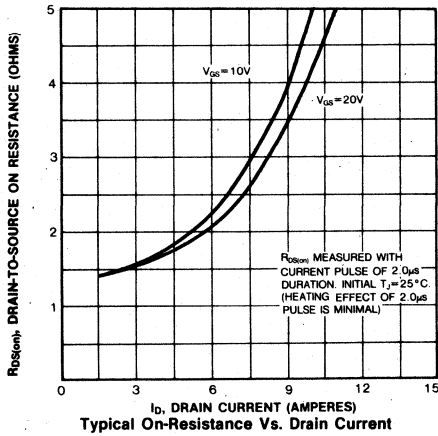
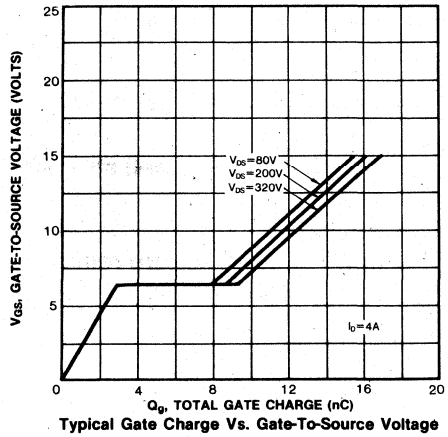
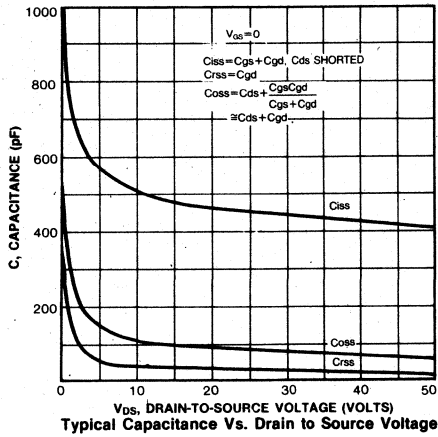

FEATURES

- Low $R_{DS(on)}$
- Improved inductive ruggedness
- Fast switching times
- Rugged polysilicon gate cell structure
- Low input capacitance
- Extended safe operating area
- Improved high temperature reliability
- TO-3 package (Standard)

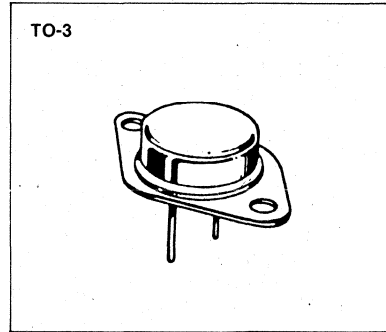

PRODUCT SUMMARY

Part Number	V _{DS}	R _{DS(on)}	I _D
IRF330	400V	1.0 Ω	5.5A
IRF331	350V	1.0 Ω	5.5A
IRF332	400V	1.5 Ω	4.5A
IRF333	350V	1.5 Ω	4.5A

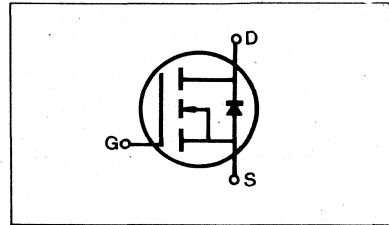

MAXIMUM RATINGS

Characteristic	Symbol	IRF330	IRF331	IRF332	IRF333	Unit
Drain-Source Voltage (1)	V _{DSS}	400	350	400	350	Vdc
Drain-Gate Voltage (R _{GS} =1.0MΩ) (1)	V _{DGR}	400	350	400	350	Vdc
Gate-Source Voltage	V _{GS}	±20				Vdc
Continuous Drain Current T _C =25°C	I _D	5.5	5.5	4.5	4.5	Adc
Continuous Drain Current T _C =100°C	I _D	3.5	3.5	3.0	3.0	Adc
Drain Current—Pulsed (3)	I _{DM}	22	22	18	18	Adc
Gate Current—Pulsed	I _{GM}	±1.5				Adc
Total Power Dissipation @ T _C =25°C Derate above 25°C	P _D	75 0.6				Watts W/°C
Operating and Storage Junction Temperature Range	T _J , T _{stg}	-55 to 150				°C
Maximum Lead Temp. for Soldering Purposes, 1/8" from case for 5 seconds	T _L	300				°C

- Notes:** (1) T_J=25°C to 150°C
 (2) Pulse test: Pulse width≤300μs, Duty Cycle≤2%
 (3) Repetitive rating: Pulse width limited by max. junction temperature

ELECTRICAL CHARACTERISTICS (T_C=25°C unless otherwise specified)

Characteristic	Symbol	Type	Min	Typ	Max	Units	Test Conditions
Drain-Source Breakdown Voltage	BV _{DSS}	IRF330 IRF332	400	—	—	V	V _{GS} =0V
		IRF331 IRF333	350	—	—	V	I _D =250μA
Gate Threshold Voltage	V _{GS(th)}	ALL	2.0	—	4.0	V	V _{DS} =V _{GS} , I _D =250μA
Gate-Source Leakage Forward	I _{GSS}	ALL	—	—	100	nA	V _{GS} =20V
Gate-Source Leakage Reverse	I _{GSS}	ALL	—	—	-100	nA	V _{GS} =-20V
Zero Gate Voltage Drain Current	I _{DSS}	ALL	—	—	250	μA	V _{DS} =Max. Rating, V _{GS} =0V
			—	—	1000	μA	V _{DS} =Max. Rating×0.8, V _{GS} =0V, T _C =125°C
On-State Drain-Source Current (2)	I _{D(on)}	IRF330 IRF331	5.5	—	—	A	V _{DS} >I _{D(on)} ×R _{DS(on) max.} , V _{GS} =10V
		IRF332 IRF333	4.5	—	—	A	
Static Drain-Source On-State Resistance (2)	R _{DS(on)}	IRF330 IRF331	—	0.8	1.0	Ω	V _{GS} =10V, I _D =3.0A
		IRF332 IRF333	—	1.0	1.5	Ω	
Forward Transconductance (2)	g _{fs}	ALL	3.0	4.4	—	Ω	V _{DS} >I _{D(on)} ×R _{DS(on) max.} , I _D =3.0A
Input Capacitance	C _{iss}	ALL	—	730	900	pF	V _{GS} =0V, V _{DS} =25V, f=1.0MHz
Output Capacitance	C _{oss}	ALL	—	100	300	pF	
Reverse Transfer Capacitance	C _{rss}	ALL	—	50	80	pF	
Turn-On Delay Time	t _{d(on)}	ALL	—	—	30	ns	V _{DD} =0.5BV _{DSS} , I _D =3.0A, Z _O =15 Ω (MOSFET switching times are essentially independent of operating temperature.)
Rise Time	t _r	ALL	—	—	35	ns	
Turn-Off Delay Time	t _{d(off)}	ALL	—	—	55	ns	
Fall Time	t _f	ALL	—	—	35	ns	
Total Gate Charge (Gate-Source Plus Gate-Drain)	Q _g	ALL	—	18	30	nC	V _{GS} =10V, I _D =7.0A, V _{DS} =0.8 Max. Rating (Gate charge is essentially independent of operating temperature.)
Gate-Source Charge	Q _{gs}	ALL	—	4.0	—	nC	
Gate-Drain ("Miller") Charge	Q _{gd}	ALL	—	14	—	nC	

THERMAL RESISTANCE

Junction-to-Case	R _{thJC}	ALL	—	—	1.67	K/W	
Case-to-Sink	R _{thCS}	ALL	—	0.1	—	K/W	Mounting surface flat, smooth, and greased
Junction-to-Ambient	R _{thJA}	ALL	—	—	30	K/W	Free Air Operation

- Notes:** (1) T_J=25°C to 150°C
 (2) Pulse test: Pulse width≤300μs, Duty Cycle≤2%
 (3) Repetitive rating: Pulse width limited by max. junction temperature

SOURCE-DRAIN DIODE RATINGS AND CHARACTERISTICS

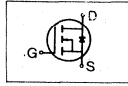
Characteristic	Symbol	Type	Min	Typ	Max	Units	Test Conditions
Continuous Source Current (Body Diode)	I_S	IRF330	—	—	5.5	A	Modified MOSFET symbol showing the integral reverse P-N junction rectifier 
		IRF331	—	—	5.5	A	
		IRF332	—	—	4.5	A	
		IRF333	—	—	4.5	A	
Pulse Source Current (Body Diode) (3)	I_{SM}	IRF330	—	—	22	A	
		IRF331	—	—	22	A	
		IRF332	—	—	18	A	
		IRF333	—	—	18	A	
Diode Forward Voltage (2)	V_{SD}	IRF330	—	—	1.6	V	$T_C=25^\circ\text{C}$, $I_S=5.5\text{A}$, $V_{GS}=0\text{V}$
		IRF331	—	—	1.6	V	$T_C=25^\circ\text{C}$, $I_S=5.5\text{A}$, $V_{GS}=0\text{V}$
		IRF332	—	—	1.5	V	$T_C=25^\circ\text{C}$, $I_S=4.5\text{A}$, $V_{GS}=0\text{V}$
		IRF333	—	—	1.5	V	$T_C=25^\circ\text{C}$, $I_S=4.5\text{A}$, $V_{GS}=0\text{V}$
Reverse Recovery Time	t_{rr}	ALL	—	600	—	ns	$T_J=150^\circ\text{C}$, $I_F=5.5\text{A}$, $dI_F/dt=100\text{A}/\mu\text{s}$

Notes: (1) $T_J=25^\circ\text{C}$ to 150°C (2) Pulse test: Pulse width $\leq 300\mu\text{s}$, Duty Cycle $\leq 2\%$
 (3) Repetitive rating: Pulse width limited by max. junction temperature

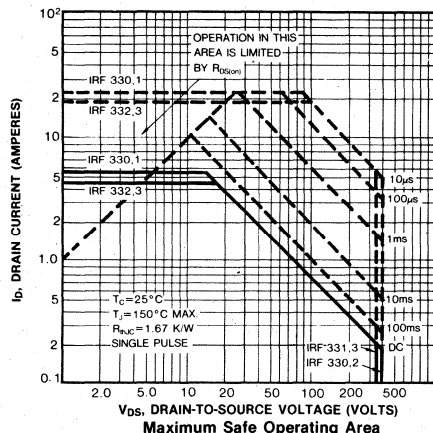
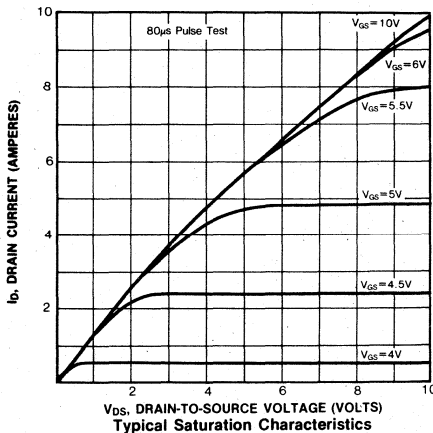
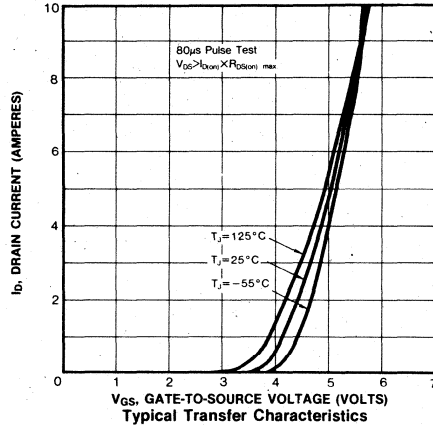
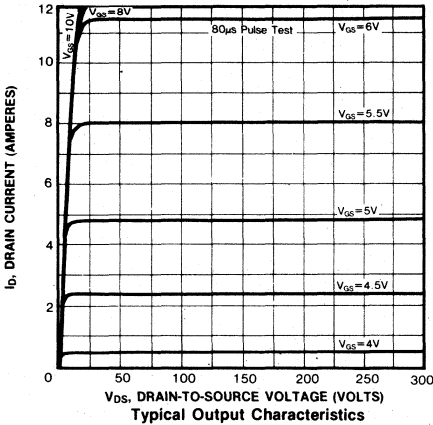

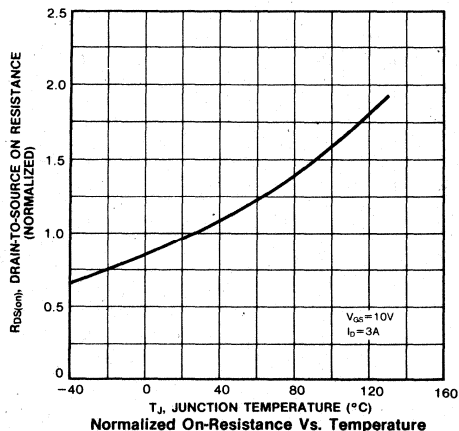
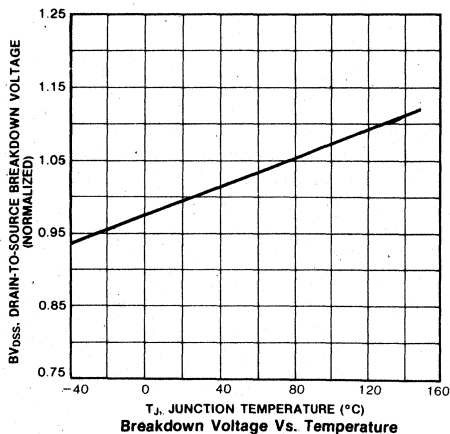
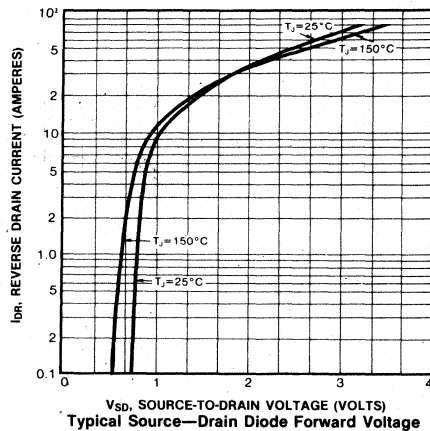
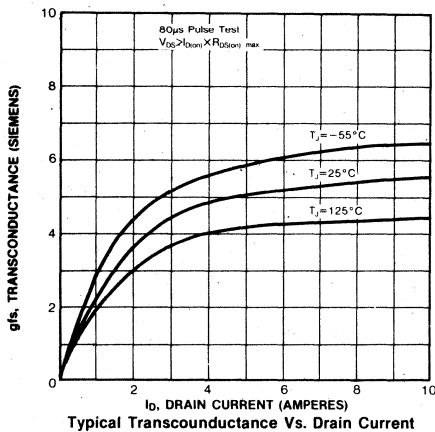
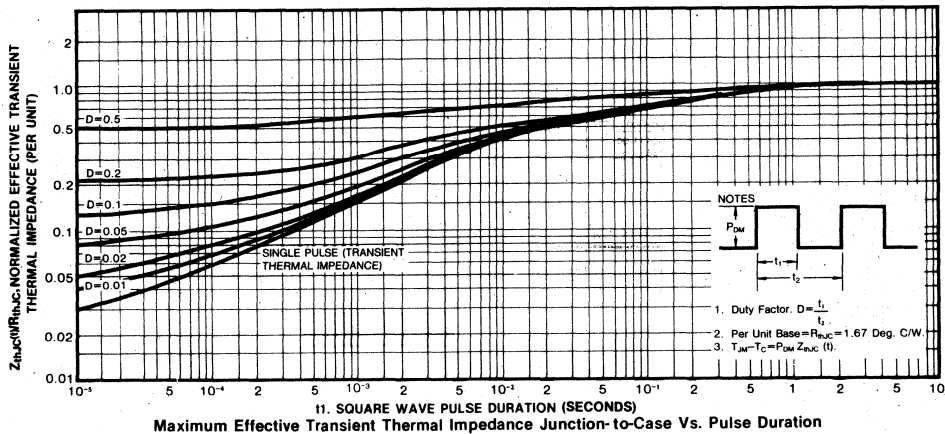

IRF330/331/332/333

N-CHANNEL POWER MOSFETS

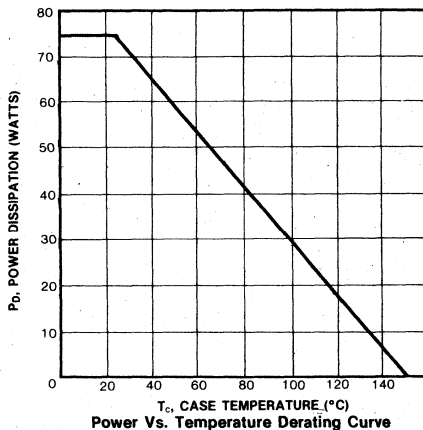
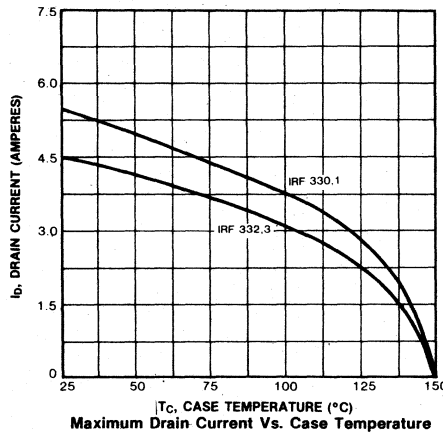
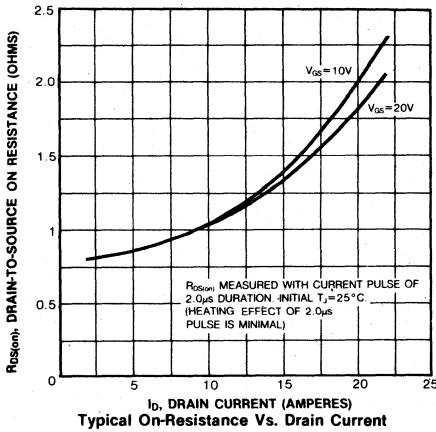
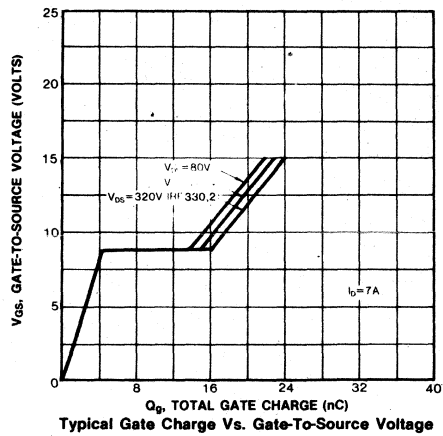
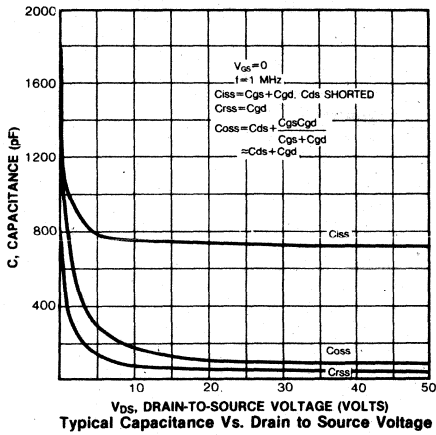

4

FEATURES

- Low $R_{DS(on)}$
- Improved inductive ruggedness
- Fast switching times
- Rugged polysilicon gate cell structure
- Low input capacitance
- Extended safe operating area
- Improved high temperature reliability
- TO-3 package (Standard)

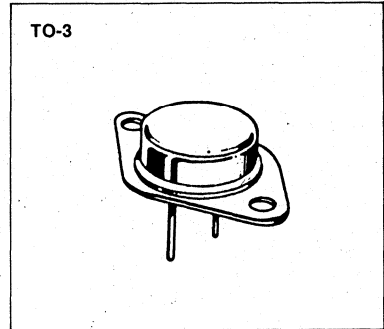

PRODUCT SUMMARY

Part Number	V _{DS}	R _{DS(on)}	I _D
IRF340	400V	0.55 Ω	10A
IRF341	350V	0.55 Ω	10A
IRF342	400V	0.80 Ω	8.0A
IRF343	350V	0.80 Ω	8.0A

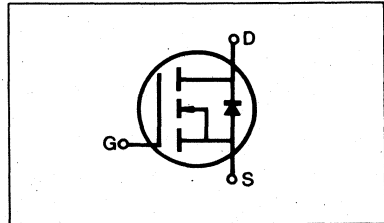

MAXIMUM RATINGS

Characteristic	Symbol	IRF340	IRF341	IRF342	IRF343	Unit
Drain-Source Voltage (1)	V _{DSS}	400	350	400	350	Vdc
Drain-Gate Voltage (R _{GS} =1.0MΩ)(1)	V _{DGR}	400	350	400	350	Vdc
Gate-Source Voltage	V _{GS}	±20				Vdc
Continuous Drain Current T _C =25°C	I _D	10	10	8.0	8.0	Adc
Continuous Drain Current T _C =100°C	I _D	6.0	6.0	5.0	5.0	Adc
Drain Current—Pulsed (3)	I _{DM}	40	40	32	32	Adc
Gate Current—Pulsed	I _{GM}	±1.5				Adc
Total Power Dissipation @ T _C =25°C Derate above 25°C	P _D	125 1.0				Watts W/°C
Operating and Storage Junction Temperature Range	T _J , T _{stg}	-55 to 150				°C
Maximum Lead Temp. for Soldering Purposes, 1/8" from case for 5 seconds	T _L	300				°C

- Notes:** (1) T_J=25°C to 150°C
 (2) Pulse test: Pulse width≤300μs, Duty Cycle≤2%
 (3) Repetitive rating: Pulse width limited by max. junction temperature

ELECTRICAL CHARACTERISTICS (T_C=25°C unless otherwise specified)

Characteristic	Symbol	Type	Min	Typ	Max	Units	Test Conditions
Drain-Source Breakdown Voltage	BV _{DSS}	IRF340 IRF342	400	—	—	V	V _{GS} =0V
		IRF341 IRF343	350	—	—	V	I _D =250μA
Gate Threshold Voltage	V _{GS(th)}	ALL	2.0	—	4.0	V	V _{DS} =V _{GS} , I _D =250μA
Gate-Source Leakage Forward	I _{GSS}	ALL	—	—	100	nA	V _{GS} =20V
Gate-Source Leakage Reverse	I _{GSS}	ALL	—	—	-100	nA	V _{GS} =-20V
Zero Gate Voltage Drain Current	I _{DSS}	ALL	—	—	250	μA	V _{DS} =Max. Rating, V _{GS} =0V
			—	—	1000	μA	V _{DS} =Max. Rating×0.8, V _{GS} =0V, T _C =125°C
On-State Drain-Source Current (2)	I _{D(on)}	IRF340 IRF341	10	—	—	A	V _{DS} >I _{D(on)} ×R _{DS(on)} max., V _{GS} =10V
		IRF342 IRF343	8.0	—	—	A	
Static Drain-Source On-State Resistance (2)	R _{DS(on)}	IRF340 IRF341	—	0.30	0.55	Ω	V _{GS} =10V, I _D =5.0A
		IRF342 IRF343	—	0.60	0.80	Ω	
Forward Transconductance (2)	g _{fs}	ALL	4.0	7.0	—	Ω	V _{DS} >I _{D(on)} ×R _{DS(on)} max., I _D =5.0A
Input Capacitance	C _{iss}	ALL	—	1300	1600	pF	V _{GS} =0V, V _{DS} =25V, f=1.0MHz
Output Capacitance	C _{oss}	ALL	—	250	450	pF	
Reverse Transfer Capacitance	C _{rss}	ALL	—	50	150	pF	
Turn-On Delay Time	t _{d(on)}	ALL	—	—	35	ns	V _{DD} =0.5BV _{DSS} , I _D =5.0A, Z _O =4.7Ω (MOSFET switching times are essentially independent of operating temperature.)
Rise Time	t _r	ALL	—	—	15	ns	
Turn-Off Delay Time	t _{d(off)}	ALL	—	—	90	ns	
Fall Time	t _f	ALL	—	—	35	ns	
Total Gate Charge (Gate-Source Plus Gate-Drain)	Q _g	ALL	—	41	60	nC	V _{GS} =10V, I _D =12A, V _{DS} =0.8 Max. Rating (Gate charge is essentially independent of operating temperature.)
Gate-Source Charge	Q _{gs}	ALL	—	6.0	—	nC	
Gate-Drain ("Miller") Charge	Q _{gd}	ALL	—	35	—	nC	

THERMAL RESISTANCE

Junction-to-Case	R _{thJC}	ALL	—	—	1.0	K/W	
Case-to-Sink	R _{thCS}	ALL	—	0.1	—	K/W	Mounting surface flat, smooth, and greased
Junction-to-Ambient	R _{thJA}	ALL	—	—	30	K/W	Free Air Operation

- Notes:** (1) T_J=25°C to 150°C
 (2) Pulse test: Pulse width≤300μs, Duty Cycle≤2%
 (3) Repetitive rating: Pulse width limited by max. junction temperature

SOURCE-DRAIN DIODE RATINGS AND CHARACTERISTICS

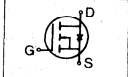
Characteristic	Symbol	Type	Min	Typ	Max	Units	Test Conditions
Continuous Source Current (Body Diode)	I_S	IRF340	—	—	10	A	Modified MOSFET symbol showing the integral reverse P-N junction rectifier 
		IRF341	—	—	10	A	
		IRF342	—	—	8.0	A	
Pulse Source Current (Body Diode) (3)	I_{SM}	IRF340	—	—	40	A	
		IRF341	—	—	40	A	
		IRF342	—	—	32	A	
Diode Forward Voltage (2)	V_{SD}	IRF340	—	—	2.0	V	$T_C=25^\circ\text{C}$, $I_S=10\text{A}$, $V_{GS}=0\text{V}$
		IRF341	—	—	2.0	V	$T_C=25^\circ\text{C}$, $I_S=10\text{A}$, $V_{GS}=0\text{V}$
		IRF342	—	—	1.9	V	$T_C=25^\circ\text{C}$, $I_S=8.0\text{A}$, $V_{GS}=0\text{V}$
IRF343	—	—	1.9	V	$T_C=25^\circ\text{C}$, $I_S=8.0\text{A}$, $V_{GS}=0\text{V}$		
Reverse Recovery Time	t_{rr}	ALL	—	800	—	ns	$T_J=150^\circ\text{C}$, $I_F=10\text{A}$, $dI_F/dt=100\text{A}/\mu\text{s}$

Notes: (1) $T_J=25^\circ\text{C}$ to 150°C (2) Pulse test: Pulse width $\leq 300\mu\text{s}$, Duty Cycle $\leq 2\%$
 (3) Repetitive rating: Pulse width limited by max. junction temperature

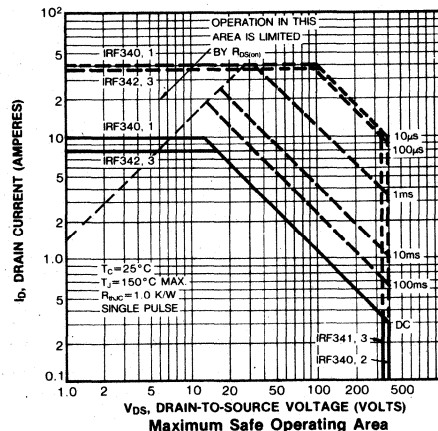
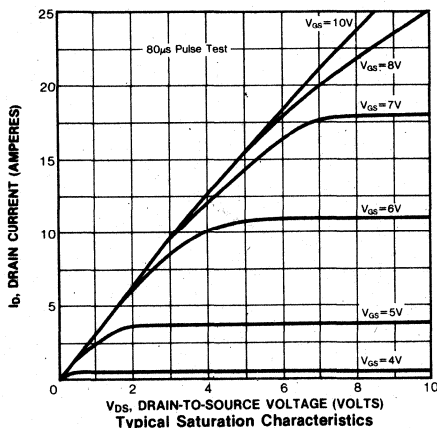
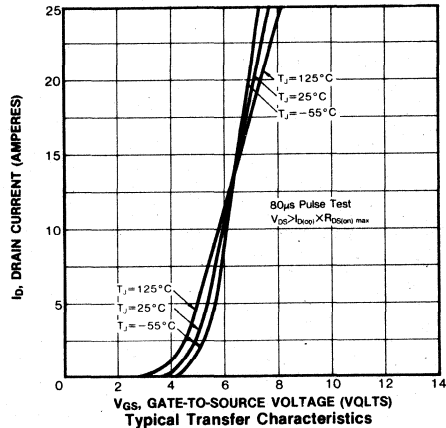
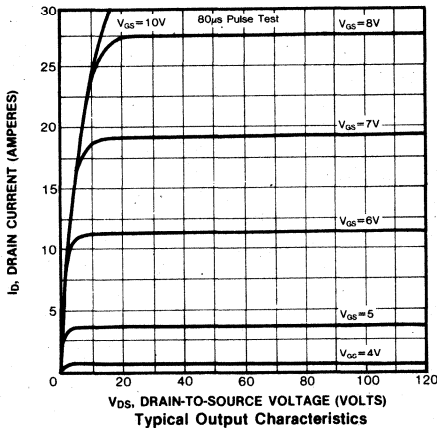

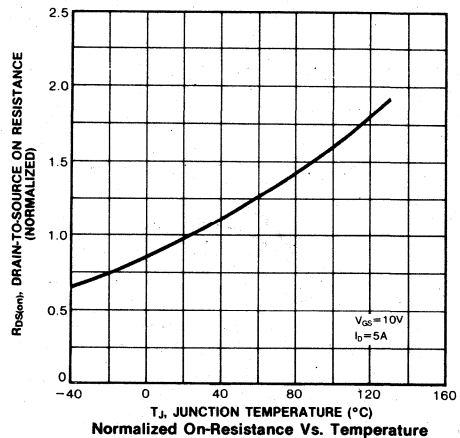
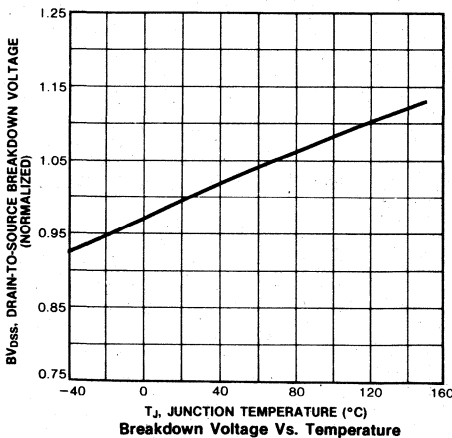
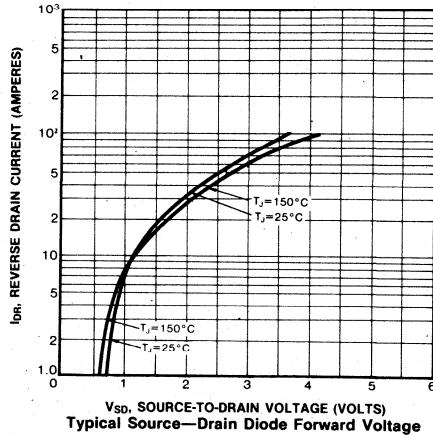
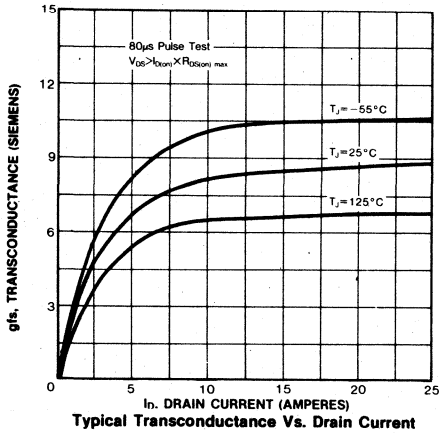
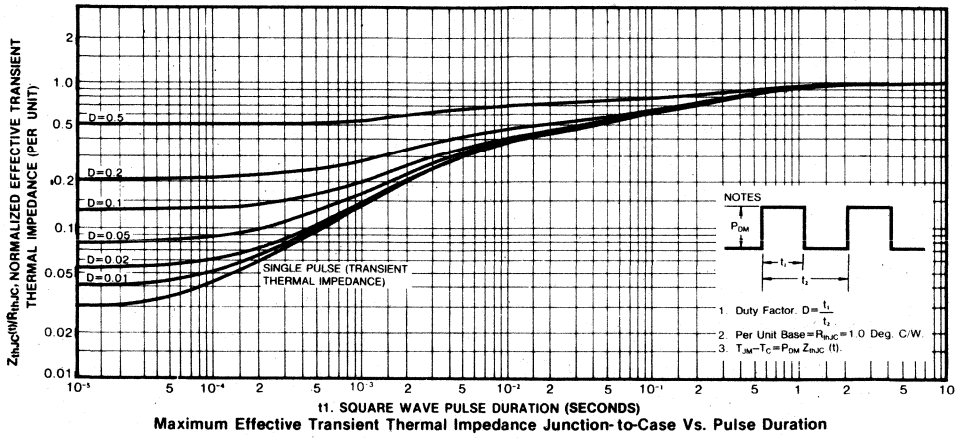

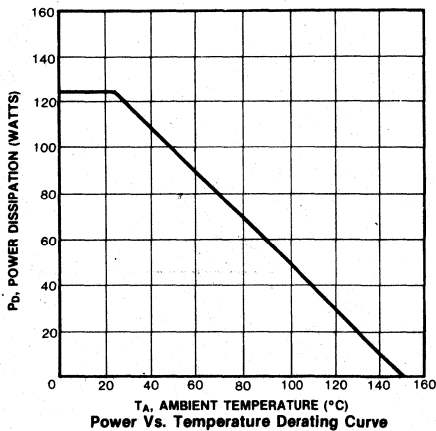
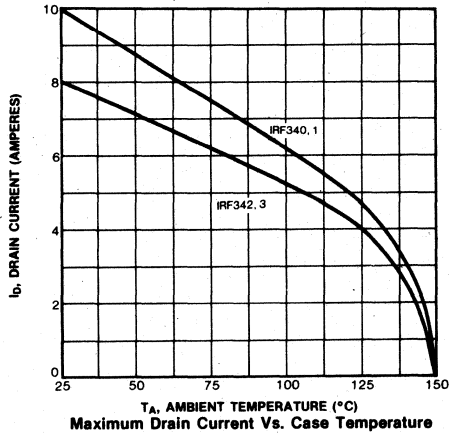
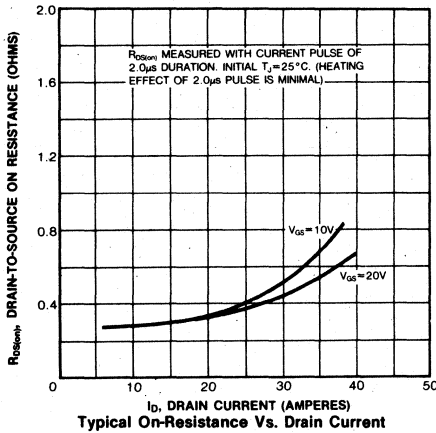
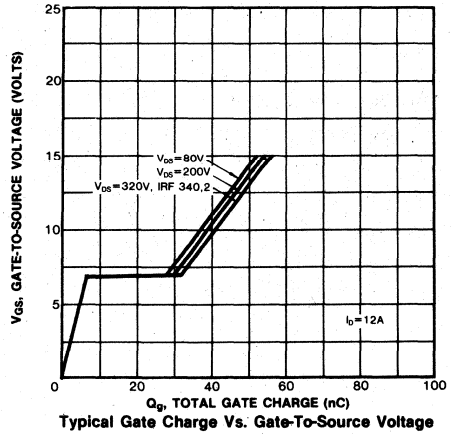
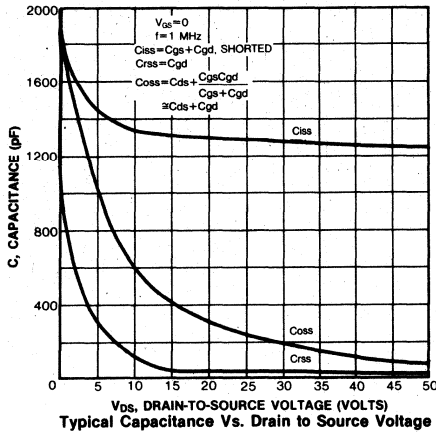

FEATURES

- Low $R_{DS(on)}$
- Improved inductive ruggedness
- Fast switching times
- Rugged polysilicon gate cell structure
- Low input capacitance
- Extended safe operating area
- Improved high temperature reliability
- TO-3 package (Standard)

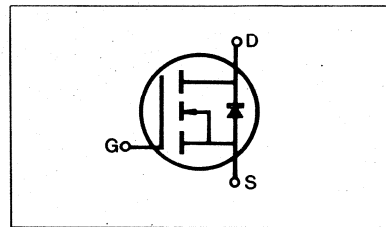
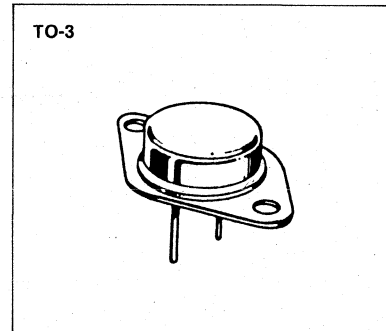

PRODUCT SUMMARY

Part Number	V _{DS}	R _{DS(on)}	I _D
IRF350	400V	0.3 Ω	15A
IRF351	350V	0.3 Ω	15A
IRF352	400V	0.4 Ω	13A
IRF353	350V	0.4 Ω	13A

MAXIMUM RATINGS

Characteristic	Symbol	IRF350	IRF351	IRF352	IRF353	Unit
Drain-Source Voltage (1)	V _{DSS}	400	350	400	350	Vdc
Drain-Gate Voltage (R _{GS} =1.0MΩ) (1)	V _{DGR}	400	350	400	350	Vdc
Gate-Source Voltage	V _{GS}	±20				Vdc
Continuous Drain Current T _C =25°C	I _D	15	15	13	13	Adc
Continuous Drain Current T _C =100°C	I _D	9.0	9.0	8.0	8.0	Adc
Drain Current—Pulsed (3)	I _{DM}	60	60	52	52	Adc
Gate Current—Pulsed	I _{GM}	±1.5				Adc
Total Power Dissipation @ T _C =25°C Derate above 25°C	P _D	150 1.2				Watts W/°C
Operating and Storage Junction Temperature Range	T _J , T _{stg}	-55 to 150				°C
Maximum Lead Temp. for Soldering Purposes, 1/8" from case for 5 seconds	T _L	300				°C

- Notes:** (1) T_J=25°C to 150°C
 (2) Pulse test: Pulse width ≤ 300μs, Duty Cycle ≤ 2%
 (3) Repetitive rating: Pulse width limited by max. junction temperature

ELECTRICAL CHARACTERISTICS (T_C=25°C unless otherwise specified)

Characteristic	Symbol	Type	Min	Typ	Max	Units	Test Conditions
Drain-Source Breakdown Voltage	BV _{DSS}	IRF350 IRF352	400	—	—	V	V _{GS} =0V
		IRF351 IRF353	350	—	—	V	I _D =250μA
Gate Threshold Voltage	V _{GS(th)}	ALL	2.0	—	4.0	V	V _{DS} =V _{GS} , I _D =250μA
Gate-Source Leakage Forward	I _{GSS}	ALL	—	—	100	nA	V _{GS} =20V
Gate-Source Leakage Reverse	I _{GSS}	ALL	—	—	-100	nA	V _{GS} =-20V
Zero Gate Voltage Drain Current	I _{DSS}	ALL	—	—	250	μA	V _{DS} =Max. Rating, V _{GS} =0V
			—	—	1000	μA	V _{DS} =Max. Rating×0.8, V _{GS} =0V, T _C =125°C
On-State Drain-Source Current (2)	I _{D(on)}	IRF350 IRF351	15	—	—	A	V _{DS} >I _{D(on)} ×R _{DS(on) max.} , V _{GS} =10V
		IRF352 IRF353	13	—	—	A	
Static Drain-Source On-State Resistance (2)	R _{DS(on)}	IRF350 IRF351	—	0.25	0.3	Ω	V _{GS} =10V, I _D =8.0A
		IRF352 IRF353	—	0.3	0.4	Ω	
Forward Transconductance (2)	g _{fs}	ALL	8.0	11	—	S	V _{DS} >I _{D(on)} ×R _{DS(on) max.} , I _D =8.0A
Input Capacitance	C _{iss}	ALL	—	2630	3000	pF	V _{GS} =0V, V _{DS} =25V, f=1.0MHz
Output Capacitance	C _{oss}	ALL	—	390	600	pF	
Reverse Transfer Capacitance	C _{rss}	ALL	—	130	200	pF	
Turn-On Delay Time	t _{d(on)}	ALL	—	—	35	ns	V _{DD} =0.5BV _{DSS} , I _D =8.0A, Z _O =4.7 Ω (MOSFET switching times are essentially independent of operating temperature.)
Rise Time	t _r	ALL	—	—	65	ns	
Turn-Off Delay Time	t _{d(off)}	ALL	—	—	150	ns	
Fall Time	t _f	ALL	—	—	75	ns	
Total Gate Charge (Gate-Source Plus Gate-Drain)	Q _g	ALL	—	73	120	nC	V _{GS} =10V, I _D =18A, V _{DS} =0.8 Max. Rating (Gate charge is essentially independent of operating temperature.)
Gate-Source Charge	Q _{gs}	ALL	—	14	—	nC	
Gate-Drain ("Miller") Charge	Q _{gd}	ALL	—	59	—	nC	

THERMAL RESISTANCE

Junction-to-Case	R _{thJC}	ALL	—	—	0.83	K/W	
Case-to-Sink	R _{thCS}	ALL	—	0.1	—	K/W	Mounting surface flat, smooth, and greased
Junction-to-Ambient	R _{thJA}	ALL	—	—	30	K/W	Free Air Operation

Notes: (1) T_J=25°C to 150°C

(2) Pulse test: Pulse width≤300μs, Duty Cycle≤2%

(3) Repetitive rating: Pulse width limited by max. junction temperature

SOURCE-DRAIN DIODE RATINGS AND CHARACTERISTICS

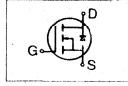
Characteristic	Symbol	Type	Min	Typ	Max	Units	Test Conditions
Continuous Source Current (Body Diode)	I _S	IRF350	—	—	15	A	Modified MOSFET symbol showing the integral reverse P-N junction rectifier 
		IRF351	—	—	15	A	
		IRF352	—	—	13	A	
		IRF353	—	—	13	A	
Pulse Source Current (Body Diode) (3)	I _{SM}	IRF350	—	—	60	A	
		IRF351	—	—	60	A	
		IRF352	—	—	52	A	
		IRF353	—	—	52	A	
Diode Forward Voltage (2)	V _{SD}	IRF350	—	—	1.6	V	T _C =25°C, I _S =15A, V _{GS} =0V
		IRF351	—	—	1.6	V	T _C =25°C, I _S =15A, V _{GS} =0V
		IRF352	—	—	1.5	V	T _C =25°C, I _S =13A, V _{GS} =0V
		IRF353	—	—	1.5	V	T _C =25°C, I _S =13A, V _{GS} =0V
Reverse Recovery Time	t _{rr}	ALL	—	1000	—	ns	T _J =150°C, I _F =15A, di/dt=100A/μs

Notes: (1) T_J=25°C to 150°C (2) Pulse test: Pulse width ≤ 300μs, Duty Cycle ≤ 2%
 (3) Repetitive rating: Pulse width limited by max. junction temperature

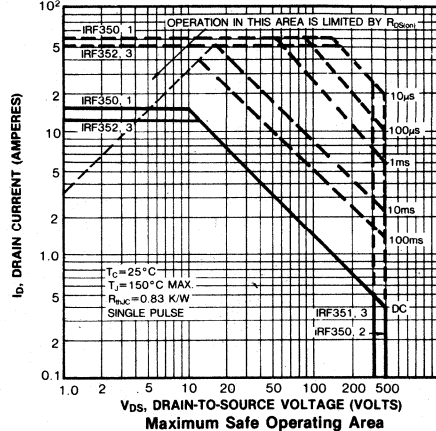
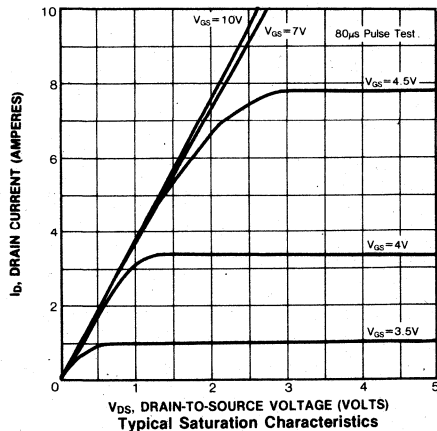
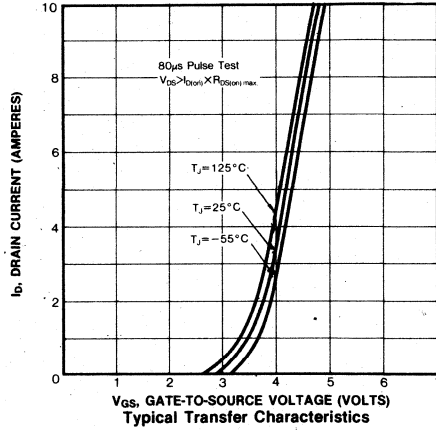
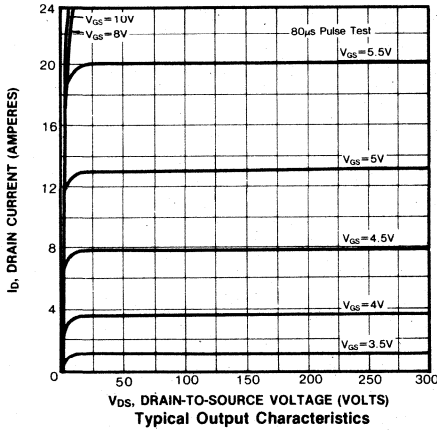

4

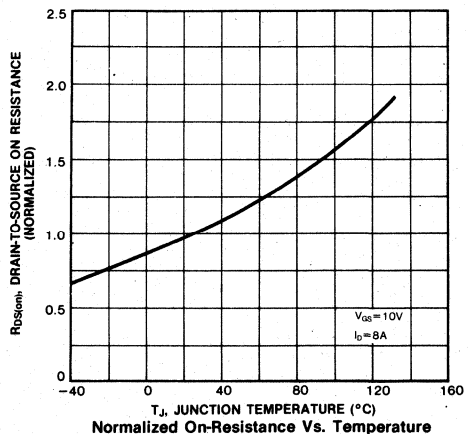
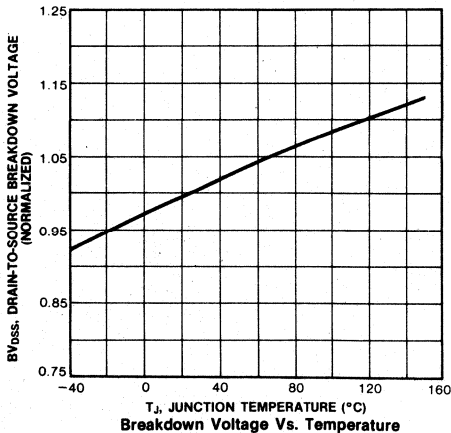
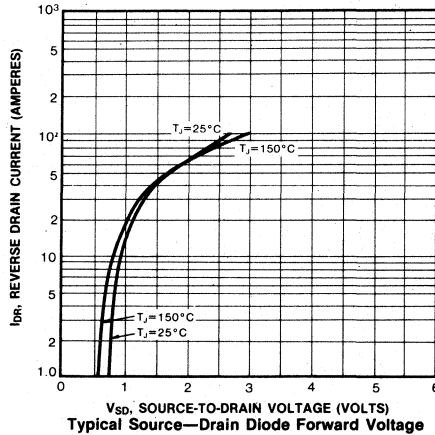
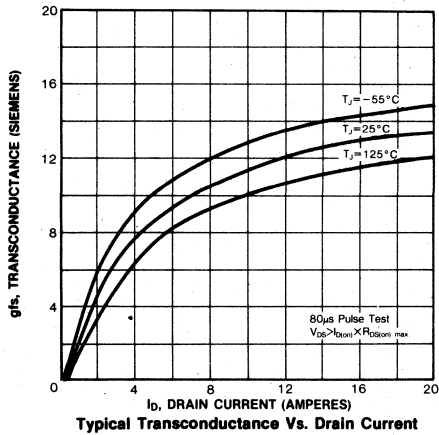
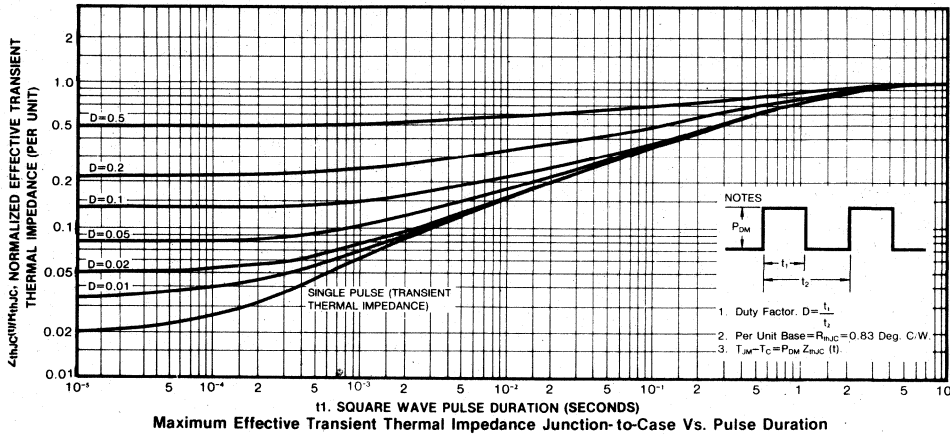

IRF350/351/352/353

N-CHANNEL POWER MOSFETS

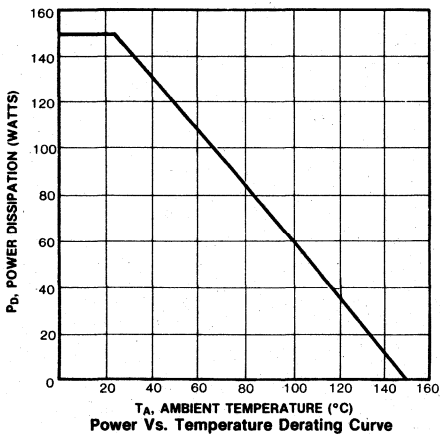
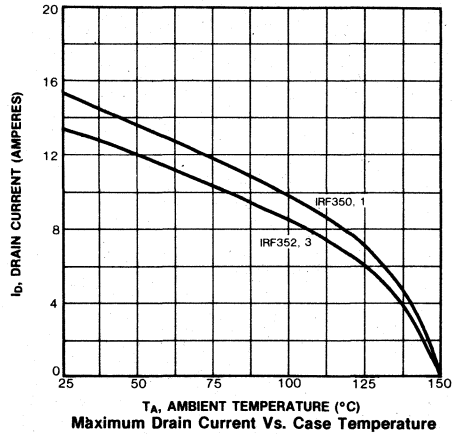
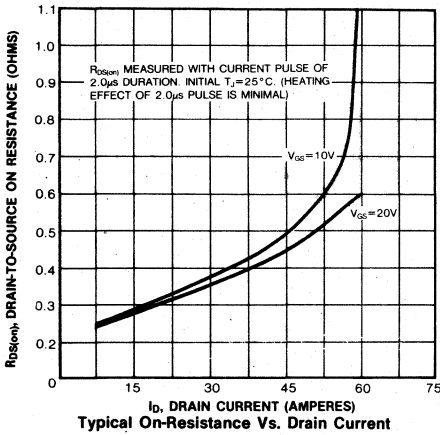
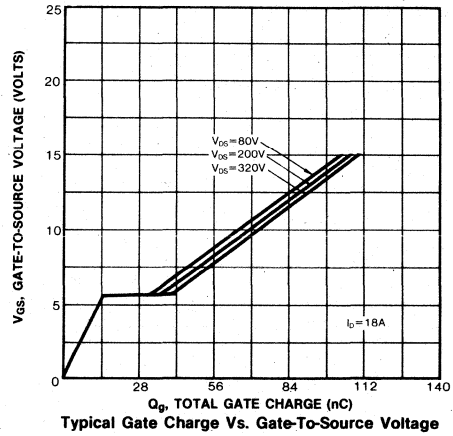
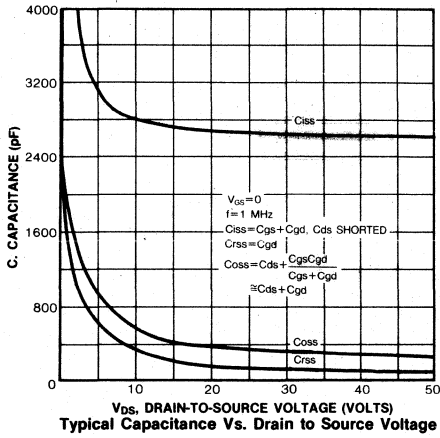

4

FEATURES

- Low $R_{DS(on)}$ at high voltage
- Improved inductive ruggedness
- Excellent high voltage stability
- Fast switching times
- Rugged polysilicon gate cell structure
- Low input capacitance
- Extended safe operating area
- Improved high temperature reliability
- TO-3 package (High voltage)

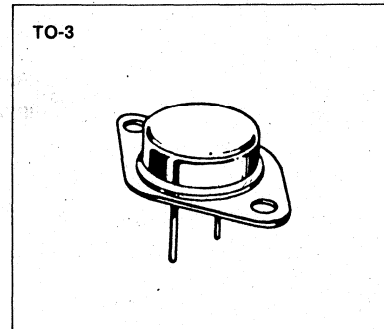

PRODUCT SUMMARY

Part Number	V_{DS}	$R_{DS(on)}$	I_D
IRF420	500V	3.0 Ω	2.5A
IRF421	450V	3.0 Ω	2.5A
IRF422	500V	4.0 Ω	2.0A
IRF423	450V	4.0 Ω	2.0A

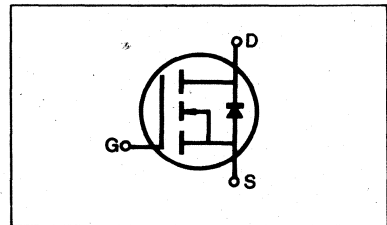

MAXIMUM RATINGS

Characteristic	Symbol	IRF420	IRF421	IRF422	IRF423	Unit
Drain-Source Voltage (1)	V_{DS}	500	450	500	450	Vdc
Drain-Gate Voltage ($R_{GS}=1.0M\Omega$) (1)	V_{DGR}	500	450	500	450	Vdc
Gate-Source Voltage	V_{GS}	± 20				Vdc
Continuous Drain Current $T_C=25^\circ C$	I_D	2.5	2.5	2.0	2.0	Adc
Continuous Drain Current $T_C=100^\circ C$	I_D	1.5	1.5	1.0	1.0	Adc
Drain Current—Pulsed (3)	I_{DM}	10	10	8.0	8.0	Adc
Gate Current—Pulsed	I_{GM}	± 1.5				Adc
Total Power Dissipation @ $T_C=25^\circ C$ Derate above $25^\circ C$	P_D	40 0.32				Watts W/ $^\circ C$
Operating and Storage Junction Temperature Range	T_J, T_{stg}	-55 to 150				$^\circ C$
Maximum Lead Temp. for Soldering Purposes, 1/8" from case for 5 seconds	T_L	300				$^\circ C$

- Notes: (1) $T_J=25^\circ C$ to $150^\circ C$
 (2) Pulse test: Pulse width $\leq 300\mu s$, Duty Cycle $\leq 2\%$
 (3) Repetitive rating: Pulse width limited by max. junction temperature

ELECTRICAL CHARACTERISTICS (T_C=25°C unless otherwise specified)

Characteristic	Symbol	Type	Min	Typ	Max	Units	Test Conditions
Drain-Source Breakdown Voltage	BV _{DSS}	IRF420 IRF422	500	—	—	V	V _{GS} =0V
		IRF421 IRF423	450	—	—	V	I _D =250μA
Gate Threshold Voltage	V _{GS(th)}	ALL	2.0	—	4.0	V	V _{DS} =V _{GS} , I _D =250μA
Gate-Source Leakage Forward	I _{GSS}	ALL	—	—	100	nA	V _{GS} =20V
Gate-Source Leakage Reverse	I _{GSS}	ALL	—	—	-100	nA	V _{GS} =-20V
Zero Gate Voltage Drain Current	I _{DSS}	ALL	—	—	250	μA	V _{DS} =Max. Rating, V _{GS} =0V
			—	—	1000	μA	V _{DS} =Max. Rating×0.8, V _{GS} =0V, T _C =125°C
On-State Drain-Source Current (2)	I _{D(on)}	IRF420 IRF421	2.5	—	—	A	V _{DS} >I _{D(on)} ×R _{DS(on) max.} , V _{GS} =10V
		IRF422 IRF423	2.0	—	—	A	
Static Drain-Source On-State Resistance (2)	R _{DS(on)}	IRF420 IRF421	—	2.5	3.0	Ω	V _{GS} =10V, I _D =1.0A
		IRF422 IRF423	—	3.0	4.0	Ω	
		—	—	—	—	—	
Forward Transconductance (2)	g _{fs}	ALL	1.0	1.75	—	Ω	V _{DS} >I _{D(on)} ×R _{DS(on) max.} , I _D =1.0A
Input Capacitance	C _{iss}	ALL	—	300	600	pF	V _{GS} =0V, V _{DS} =25V, f=1.0MHz
Output Capacitance	C _{oss}	ALL	—	75	150	pF	
Reverse Transfer Capacitance	C _{rss}	ALL	—	20	40	pF	
Turn-On Delay Time	t _{d(on)}	ALL	—	—	60	ns	V _{DD} =0.5BV _{DSS} , I _D =1.0A, Z _O =50Ω, (MOSFET switching times are essentially independent of operating temperature.)
Rise Time	t _r	ALL	—	—	50	ns	
Turn-Off Delay Time	t _{d(off)}	ALL	—	—	60	ns	
Fall Time	t _f	ALL	—	—	30	ns	
Total Gate Charge (Gate-Source Plus Gate-Drain)	Q _g	ALL	—	11	15	nC	V _{GS} =10V, I _D =3.0A, V _{DS} =0.8 Max. Rating (Gate charge is essentially independent of operating temperature.)
Gate-Source Charge	Q _{gs}	ALL	—	5.0	—	nC	
Gate-Drain ("Miller") Charge	Q _{gd}	ALL	—	6.0	—	nC	

THERMAL RESISTANCE

Junction-to-Case	R _{thJC}	ALL	—	—	3.12	K/W	
Case-to-Sink	R _{thCS}	ALL	—	0.1	—	K/W	Mounting surface flat, smooth, and greased
Junction-to-Ambient	R _{thJA}	ALL	—	—	30	K/W	Free Air Operation

- Notes:** (1) T_J=25°C to 150°C
 (2) Pulse test: Pulse width≤300μs, Duty Cycle≤2%
 (3) Repetitive rating: Pulse width limited by max. junction temperature

SOURCE-DRAIN DIODE RATINGS AND CHARACTERISTICS

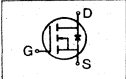
Characteristic	Symbol	Type	Min	Typ	Max	Units	Test Conditions
Continuous Source Current (Body Diode)	I _S	IRF420	—	—	2.5	A	Modified MOSFET symbol showing the integral reverse P-N junction rectifier 
		IRF421	—	—	2.5	A	
		IRF422 IRF423	—	—	2.0	A	
Pulse Source Current (Body Diode) (3)	I _{SM}	IRF420	—	—	10	A	
		IRF421	—	—	10	A	
		IRF422 IRF423	—	—	8.0	A	
Diode Forward Voltage (2)	V _{SD}	IRF420	—	—	1.4	V	T _C =25°C, I _S =2.5A, V _{GS} =0V
		IRF421	—	—	1.4	V	T _C =25°C, I _S =2.5A, V _{GS} =0V
		IRF422 IRF423	—	—	1.3	V	T _C =25°C, I _S =2.0A, V _{GS} =0V
Reverse Recovery Time	t _{rr}	ALL	—	600	—	ns	T _J =150°C, I _F =2.5A, dI _F /dt=100A/μs

Notes: (1) T_J=25°C to 150°C (2) Pulse test: Pulse width ≤ 300μs, Duty Cycle ≤ 2%
 (3) Repetitive rating: Pulse width limited by max. junction temperature

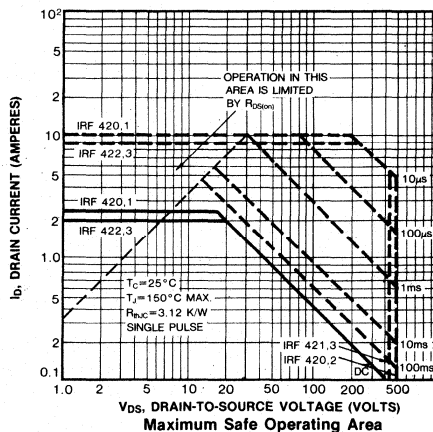
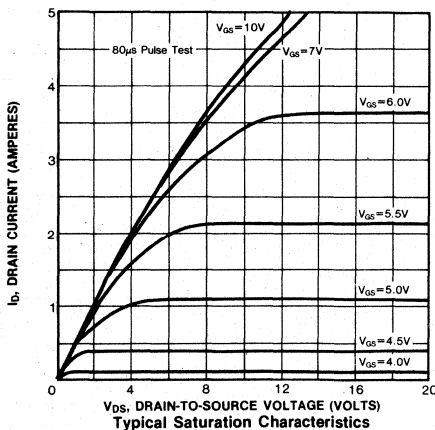
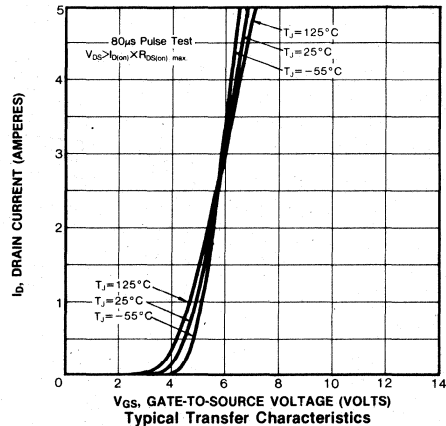
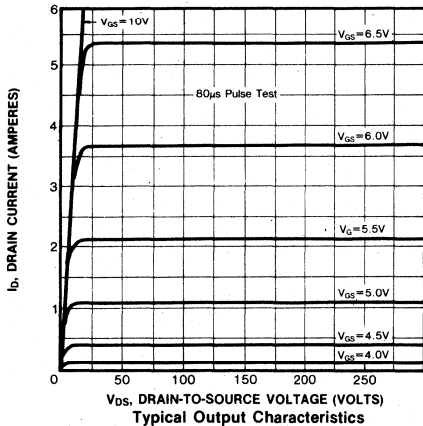

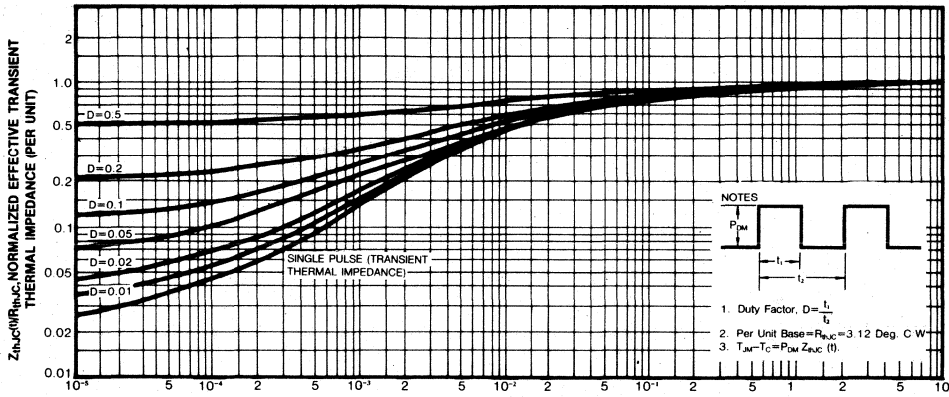

11. SQUARE WAVE PULSE DURATION (SECONDS)
Maximum Effective Transient Thermal Impedance Junction-to-Case Vs. Pulse Duration

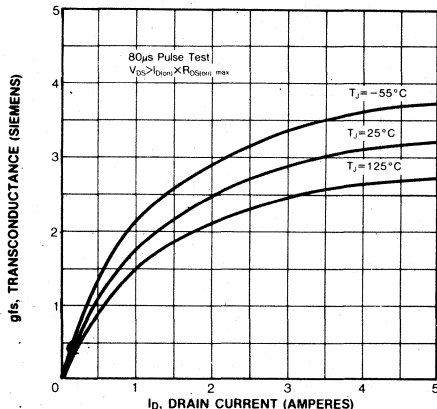

Typical Transconductance Vs. Drain Current

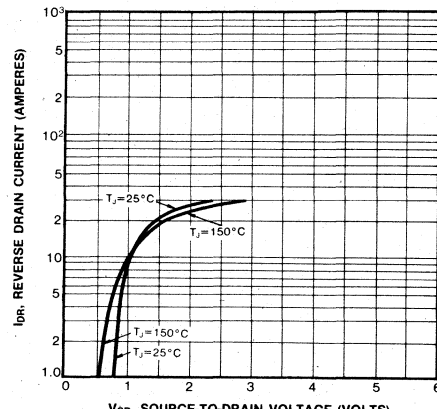

Typical Source-Drain Diode Forward Voltage

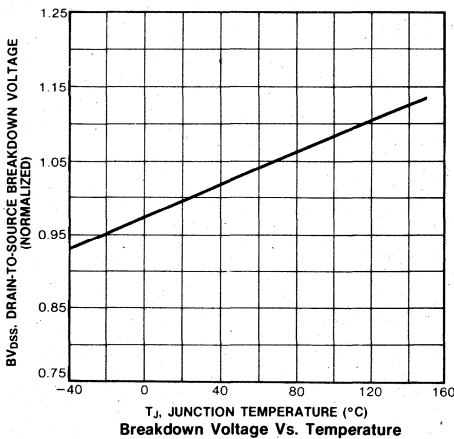

Breakdown Voltage Vs. Temperature

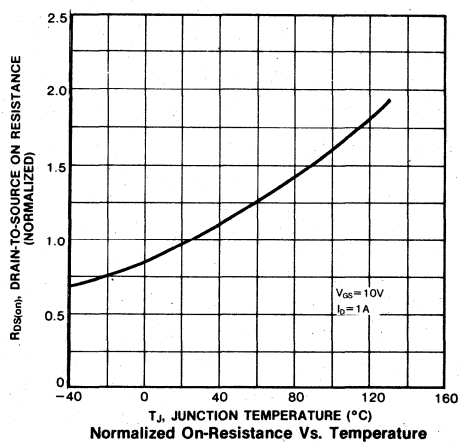

Normalized On-Resistance Vs. Temperature

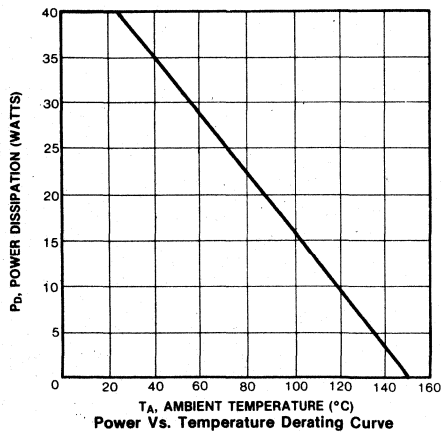
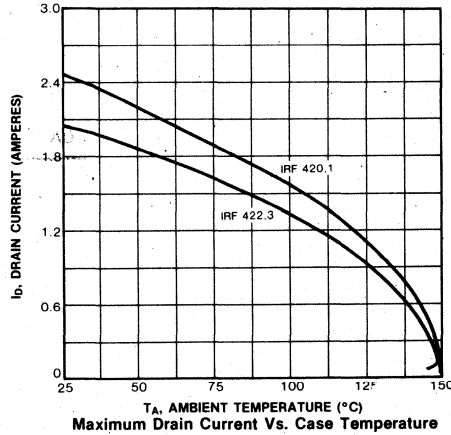
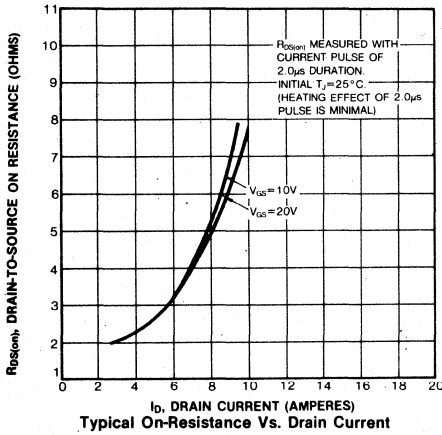
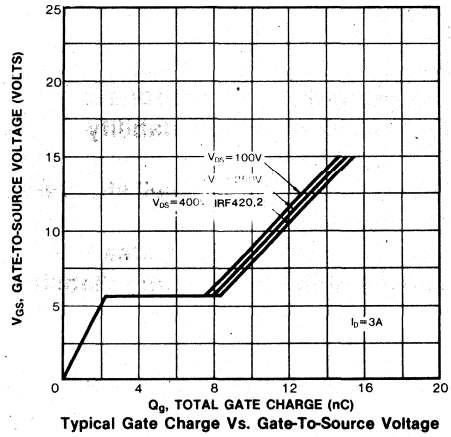
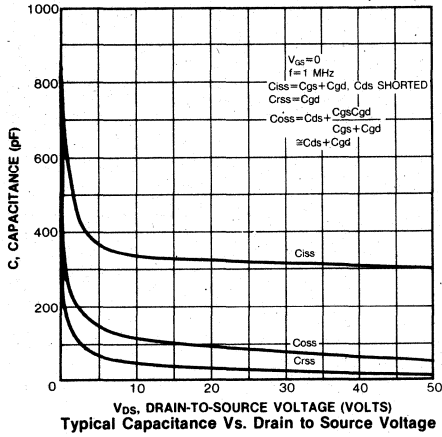

FEATURES

- Low $R_{DS(on)}$ at high voltage
- Improved inductive ruggedness
- Excellent high voltage stability
- Fast switching times
- Rugged polysilicon gate cell structure
- Low input capacitance
- Extended safe operating area
- Improved high temperature reliability
- TO-3 package (High voltage)

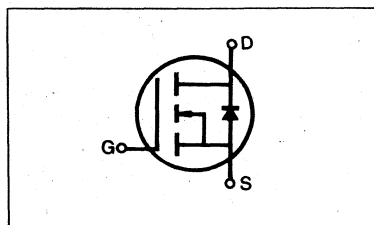
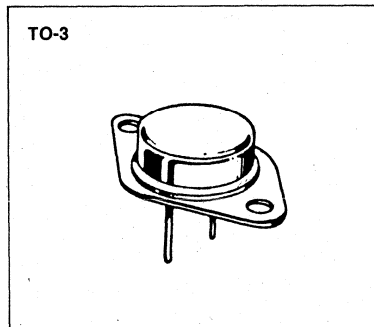

PRODUCT SUMMARY

Part Number	V_{DS}	$R_{DS(on)}$	I_D
IRF430	500V	1.5Ω	4.5A
IRF431	450V	1.5Ω	4.5A
IRF432	500V	2.0Ω	4.0A
IRF433	450V	2.0Ω	4.0A

MAXIMUM RATINGS

Characteristic	Symbol	IRF430	IRF431	IRF432	IRF433	Unit
Drain-Source Voltage (1)	V_{DSS}	500	450	500	450	Vdc
Drain-Gate Voltage ($R_{GS}=1.0M\Omega$) (1)	V_{DGR}	500	450	500	450	Vdc
Gate-Source Voltage	V_{GS}	±20				Vdc
Continuous Drain Current $T_C=25^\circ C$	I_D	4.5	4.5	4.0	4.0	Adc
Continuous Drain Current $T_C=100^\circ C$	I_D	3.0	3.0	2.5	2.5	Adc
Drain Current—Pulsed (3)	I_{DM}	18	18	16	16	Adc
Gate Current—Pulsed	I_{GM}	±1.5				Adc
Total Power Dissipation @ $T_C=25^\circ C$ Derate above $25^\circ C$	P_D	75 0.6				Watts W/°C
Operating and Storage Junction Temperature Range	T_J, T_{stg}	-55 to 150				°C
Maximum Lead Temp. for Soldering Purposes, 1/8" from case for 5 seconds	T_L	300				°C

Notes: (1) $T_J=25^\circ C$ to $150^\circ C$

(2) Pulse test: Pulse width $\leq 300\mu s$, Duty Cycle $\leq 2\%$

(3) Repetitive rating: Pulse width limited by max. junction temperature

ELECTRICAL CHARACTERISTICS (T_C=25°C unless otherwise specified)

Characteristic	Symbol	Type	Min	Typ	Max	Units	Test Conditions
Drain-Source Breakdown Voltage	BV _{DSS}	IRF430	500	—	—	V	V _{GS} =0V
		IRF432					
		IRF431 IRF433	450	—	—	V	I _D =250μA
Gate Threshold Voltage	V _{GS(th)}	ALL	2.0	—	4.0	V	V _{DS} =V _{GS} , I _D =250μA
Gate-Source Leakage Forward	I _{GSS}	ALL	—	—	100	nA	V _{GS} =20V
Gate-Source Leakage Reverse	I _{GSS}	ALL	—	—	-100	nA	V _{GS} =-20V
Zero Gate Voltage Drain Current	I _{DSS}	ALL	—	—	250	μA	V _{DS} =Max. Rating, V _{GS} =0V
			—	—	1000	μA	V _{DS} =Max. Rating×0.8, V _{GS} =0V, T _C =125°C
On-State Drain-Source Current (2)	I _{D(on)}	IRF430	4.5	—	—	A	V _{DS} >I _{D(on)} ×R _{DS(on) max.} , V _{GS} =10V
		IRF431					
		IRF432 IRF433	4.0	—	—	A	
Static Drain-Source On-State Resistance (2)	R _{DS(on)}	IRF430	—	0.95	1.5	Ω	V _{GS} =10V, I _D =2.5A
		IRF431					
		IRF432 IRF433	—	1.4	2.0	Ω	
Forward Transconductance (2)	g _{fs}	ALL	2.5	3.2	—	Ω	V _{DS} >I _{D(on)} ×R _{DS(on) max.} , I _D =2.5A
Input Capacitance	C _{iss}	ALL	—	720	800	pF	V _{GS} =0V, V _{DS} =25V, f=1.0MHz
Output Capacitance	C _{oss}	ALL	—	110	200	pF	
Reverse Transfer Capacitance	C _{rss}	ALL	—	50	60	pF	
Turn-On Delay Time	t _{d(on)}	ALL	—	—	30	ns	V _{DD} =0.5BV _{DSS} , I _D =2.5A, Z _O =15 Ω (MOSFET switching times are essentially independent of operating temperature.)
Rise Time	t _r	ALL	—	—	30	ns	
Turn-Off Delay Time	t _{d(off)}	ALL	—	—	55	ns	
Fall Time	t _f	ALL	—	—	30	ns	
Total Gate Charge (Gate-Source Plus Gate-Drain)	Q _g	ALL	—	22	30	nC	V _{GS} =10V, I _D =6.0A, V _{DS} =0.8 Max. Rating (Gate charge is essentially independent of operating temperature.)
Gate-Source Charge	Q _{gs}	ALL	—	4.2	—	nC	
Gate-Drain ("Miller") Charge	Q _{gd}	ALL	—	17.8	—	nC	

THERMAL RESISTANCE

Junction-to-Case	R _{thJC}	ALL	—	—	1.67	K/W	
Case-to-Sink	R _{thCS}	ALL	—	0.1	—	K/W	Mounting surface flat, smooth, and greased
Junction-to-Ambient	R _{thJA}	ALL	—	—	30	K/W	Free Air Operation

Notes: (1) T_J=25°C to 150°C

(2) Pulse test: Pulse width≤300μs, Duty Cycle≤2%

(3) Repetitive rating: Pulse width limited by max. junction temperature

SOURCE-DRAIN DIODE RATINGS AND CHARACTERISTICS

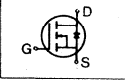
Characteristic	Symbol	Type	Min	Typ	Max	Units	Test Conditions
Continuous Source Current (Body Diode)	I_S	IRF430	—	—	4.5	A	Modified MOSFET symbol showing the integral reverse P-N junction rectifier 
		IRF431	—	—	4.0	A	
Pulse Source Current (Body Diode) (3)	I_{SM}	IRF430	—	—	18	A	
		IRF431	—	—	16	A	
Diode Forward Voltage (2)	V_{SD}	IRF430	—	—	1.4	V	$T_C=25^\circ\text{C}$, $I_S=4.5\text{A}$, $V_{GS}=0\text{V}$
		IRF431	—	—	1.3	V	$T_C=25^\circ\text{C}$, $I_S=4.0\text{A}$, $V_{GS}=0\text{V}$
Reverse Recovery Time	t_{rr}	ALL	—	800	—	ns	$T_J=150^\circ\text{C}$, $I_F=4.5\text{A}$, $dI_F/dt=100\text{A}/\mu\text{s}$

Notes: (1) $T_J=25^\circ\text{C}$ to 150°C (2) Pulse test: Pulse width $\leq 300\mu\text{s}$, Duty Cycle $\leq 2\%$
 (3) Repetitive rating: Pulse width limited by max. junction temperature

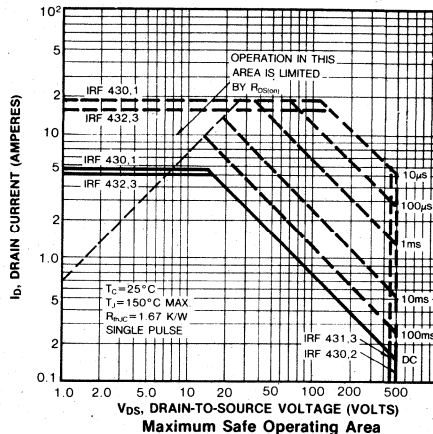
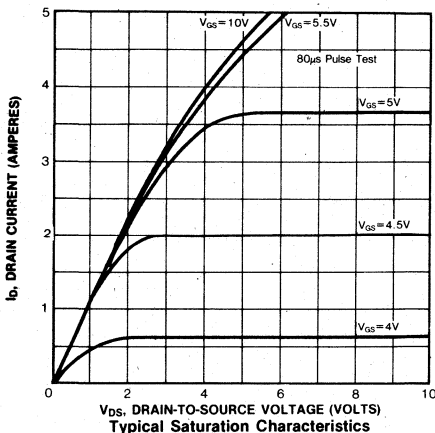
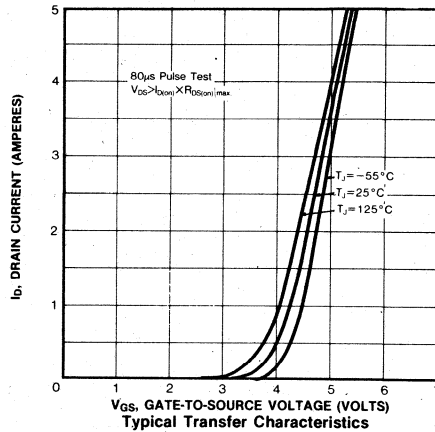
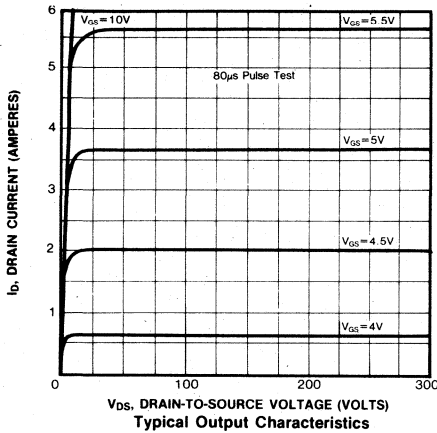

4

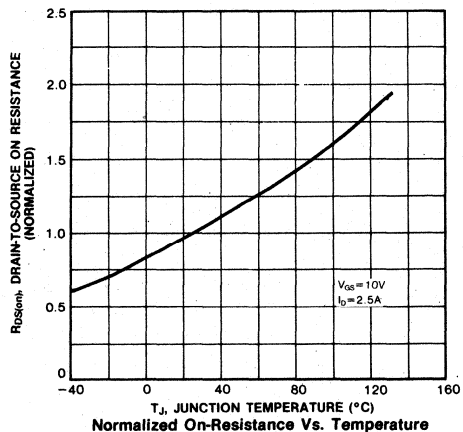
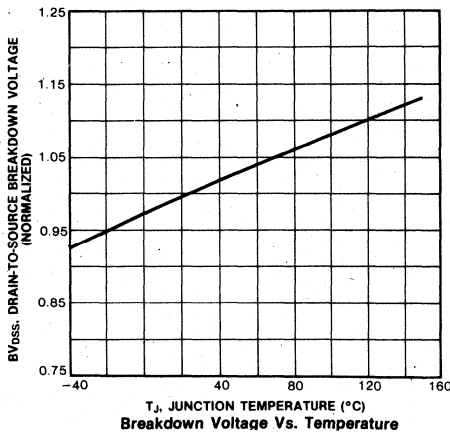
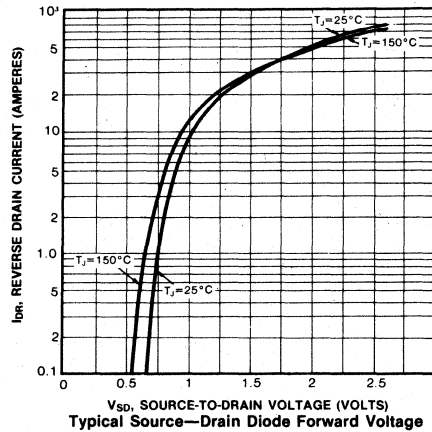
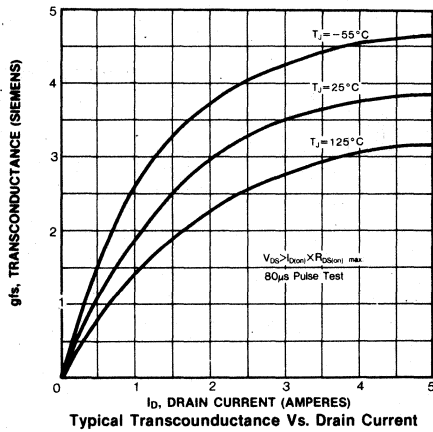
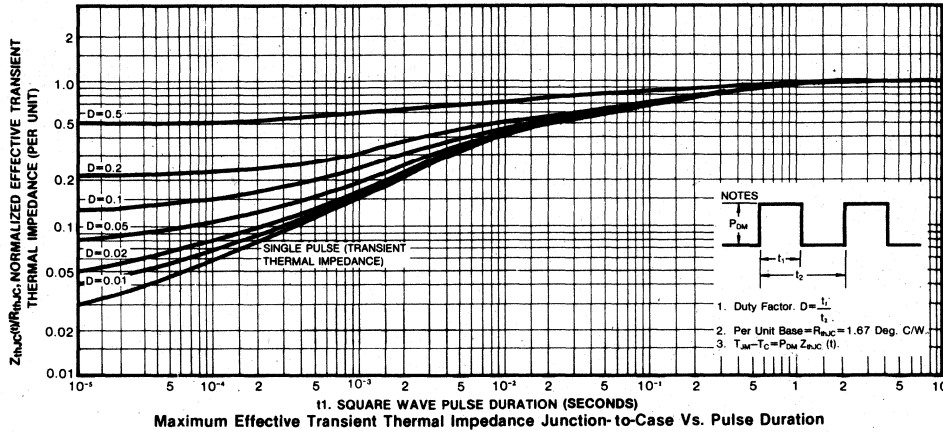

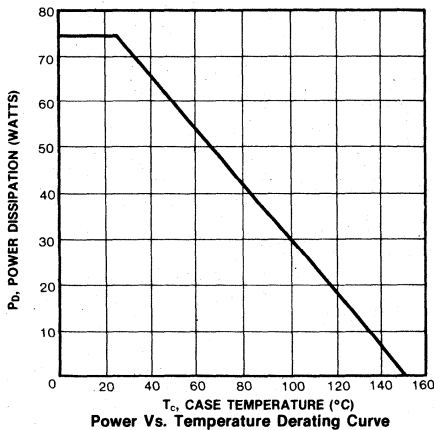
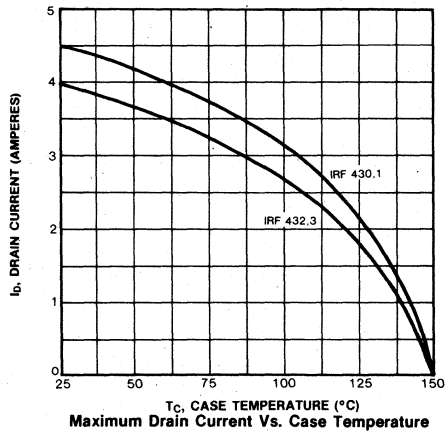
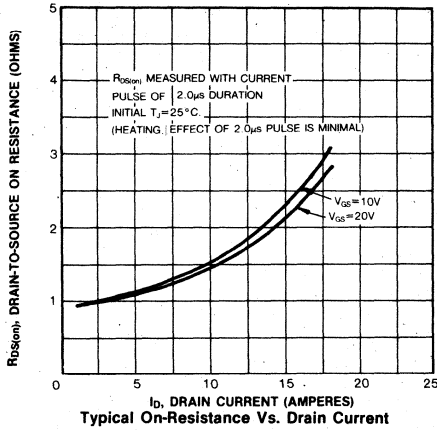
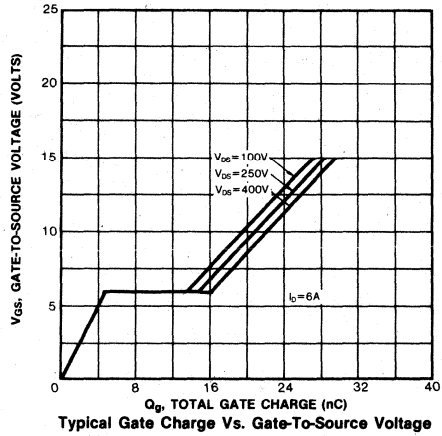
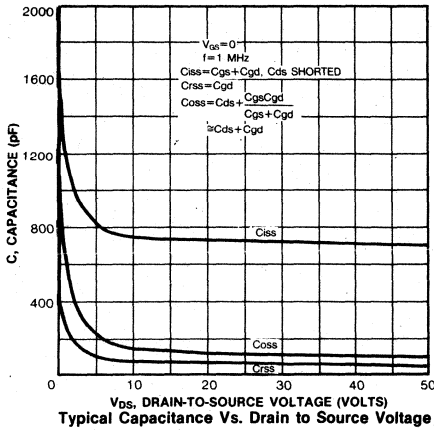

4

FEATURES

- Low $R_{DS(on)}$ at high voltage
- Improved inductive ruggedness
- Excellent high voltage stability
- Fast switching times
- Rugged polysilicon gate cell structure
- Low input capacitance
- Extended safe operating area
- Improved high temperature reliability
- TO-3 package (High voltage)

PRODUCT SUMMARY

Part Number	V _{DS}	R _{DS(on)}	I _D
IRF440	500V	0.85 Ω	8.0A
IRF441	450V	0.85 Ω	8.0A
IRF442	500V	1.10 Ω	7.0A
IRF443	450V	1.10 Ω	7.0A

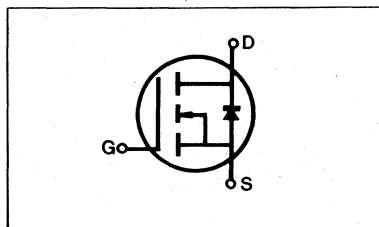
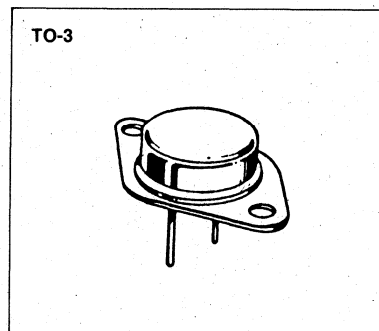

MAXIMUM RATINGS

Characteristic	Symbol	IRF440	IRF441	IRF442	IRF443	Unit
Drain-Source Voltage (1)	V _{DS}	500	450	500	450	Vdc
Drain-Gate Voltage (R _{GS} =1.0MΩ) (1)	V _{DGR}	500	450	500	450	Vdc
Gate-Source Voltage	V _{GS}	±20				Vdc
Continuous Drain Current T _C =25°C	I _D	8.0	8.0	7.0	7.0	Adc
Continuous Drain Current T _C =100°C	I _D	5.0	5.0	4.0	4.0	Adc
Drain Current—Pulsed (3)	I _{DM}	32	32	28	28	Adc
Gate Current—Pulsed	I _{GM}	±1.5				Adc
Total Power Dissipation @ T _C =25°C Derate above 25°C	P _D	125 1.0				Watts W/°C
Operating and Storage Junction Temperature Range	T _J , T _{stg}	-55 to 150				°C
Maximum Lead Temp. for Soldering Purposes, 1/8" from case for 5 seconds	T _L	300				°C

- Notes:** (1) T_J=25°C to 150°C
 (2) Pulse test: Pulse width ≤ 300μs, Duty Cycle ≤ 2%
 (3) Repetitive rating: Pulse width limited by max. junction temperature

ELECTRICAL CHARACTERISTICS (T_C=25°C unless otherwise specified)

Characteristic	Symbol	Type	Min	Typ	Max	Units	Test Conditions
Drain-Source Breakdown Voltage	BV _{DSS}	IRF440 IRF442	500	—	—	V	V _{GS} =0V
		IRF441 IRF443	450	—	—	V	I _D =250μA
Gate Threshold Voltage	V _{GS(th)}	ALL	2.0	—	4.0	V	V _{DS} =V _{GS} , I _D =250μA
Gate-Source Leakage Forward	I _{GSS}	ALL	—	—	100	nA	V _{GS} =20V
Gate-Source Leakage Reverse	I _{GSS}	ALL	—	—	-100	nA	V _{GS} =-20V
Zero Gate Voltage Drain Current	I _{DSS}	ALL	—	—	250	μA	V _{DS} =Max. Rating, V _{GS} =0V
			—	—	1000	μA	V _{DS} =Max. Rating×0.8, V _{GS} =0V, T _C =125°C
On-State Drain-Source Current (2)	I _{D(on)}	IRF440 IRF441	8.0	—	—	A	V _{DS} >I _{D(on)} ×R _{DS(on)} max., V _{GS} =10V
		IRF442 IRF443	7.0	—	—	A	
Static Drain-Source On-State Resistance (2)	R _{DS(on)}	IRF440 IRF441	—	0.6	0.85	Ω	V _{GS} =10V, I _D =4.0A
		IRF442 IRF443	—	1.0	1.1	Ω	
Forward Transconductance (2)	g _{fs}	ALL	4.0	6.5	—	Ω	V _{DS} >I _{D(on)} ×R _{DS(on)} max., I _D =4.0A
Input Capacitance	C _{iss}	ALL	—	1200	1600	pF	V _{GS} =0V, V _{DS} =25V, f=1.0MHz
Output Capacitance	C _{oss}	ALL	—	230	350	pF	
Reverse Transfer Capacitance	C _{rss}	ALL	—	65	150	pF	
Turn-On Delay Time	t _{d(on)}	ALL	—	—	35	ns	V _{DD} =0.5BV _{DSS} , I _D =4.0A, Z _O =4.7 Ω (MOSFET switching times are essentially independent of operating temperature.)
Rise Time	t _r	ALL	—	—	15	ns	
Turn-Off Delay Time	t _{d(off)}	ALL	—	—	90	ns	
Fall Time	t _f	ALL	—	—	30	ns	
Total Gate Charge (Gate-Source Plus Gate-Drain)	Q _g	ALL	—	34	60	nC	V _{GS} =10V, I _D =10A, V _{DS} =0.8 Max. Rating (Gate charge is essentially independent of operating temperature.)
Gate-Source Charge	Q _{gs}	ALL	—	6.0	—	nC	
Gate-Drain ("Miller") Charge	Q _{gd}	ALL	—	28	—	nC	

THERMAL RESISTANCE

Junction to Case	R _{thJC}	ALL	—	—	1.0	K/W	
Case-to-Sink	R _{thCS}	ALL	—	0.1	—	K/W	Mounting surface flat, smooth, and greased
Junction-to-Ambient	R _{thJA}	ALL	—	—	30	K/W	Free Air Operation

- Notes:** (1) T_C = 25°C to 150°C
 (2) Pulse test: Pulse width ≤ 300μs, Duty Cycle ≤ 2%
 (3) Repetitive rating: Pulse width limited by max. junction temperature

SOURCE-DRAIN DIODE RATINGS AND CHARACTERISTICS

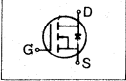
Characteristic	Symbol	Type	Min	Typ	Max	Units	Test Conditions
Continuous Source Current (Body Diode)	I_S	IRF440	—	—	8.0	A	Modified MOSFET symbol showing the integral reverse P-N junction rectifier 
		IRF441	—	—	7.0	A	
Pulse Source Current (Body Diode) (3)	I_{SM}	IRF440	—	—	32	A	
		IRF441	—	—	28	A	
Diode Forward Voltage (2)	V_{SD}	IRF440	—	—	2.0	V	$T_C=25^\circ\text{C}$, $I_S=8.0\text{A}$, $V_{GS}=0\text{V}$
		IRF441	—	—	1.9	V	$T_C=25^\circ\text{C}$, $I_S=7.0\text{A}$, $V_{GS}=0\text{V}$
Reverse Recovery Time	t_{rr}	ALL	—	1100	—	ns	$T_J=150^\circ\text{C}$, $I_F=8.0\text{A}$, $dI_F/dt=100\text{A}/\mu\text{s}$

Notes: (1) $T_J=25^\circ\text{C}$ to 150°C (2) Pulse test: Pulse width $\leq 300\mu\text{s}$, Duty Cycle $\leq 2\%$
 (3) Repetitive rating: Pulse width limited by max. junction temperature

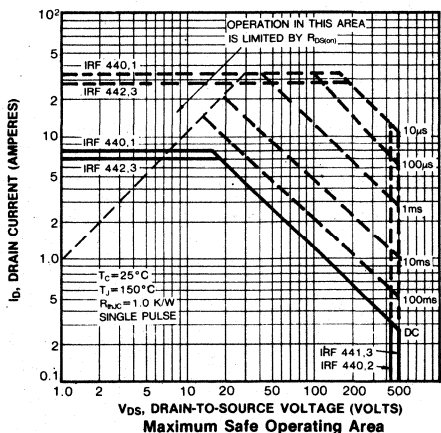
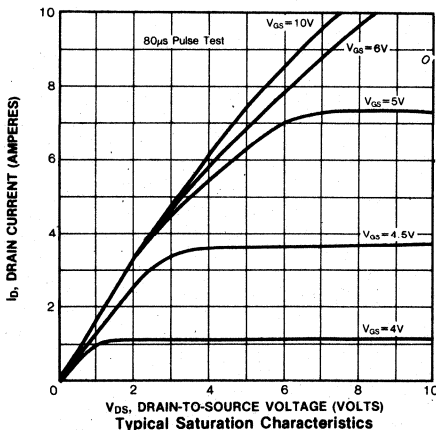
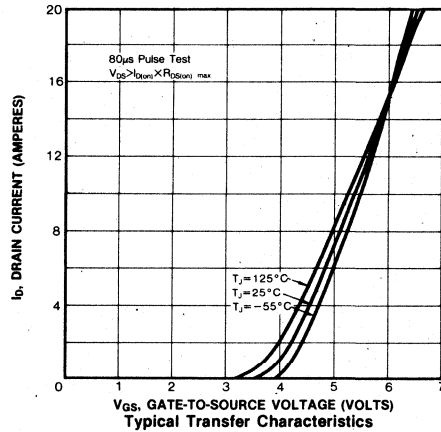
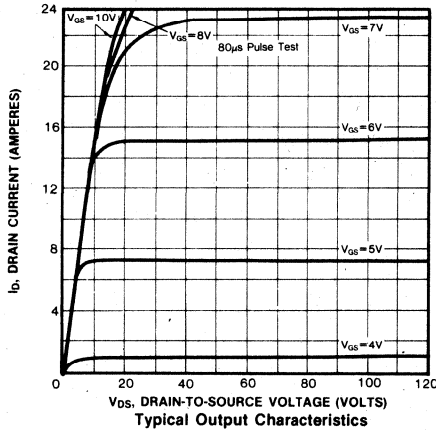

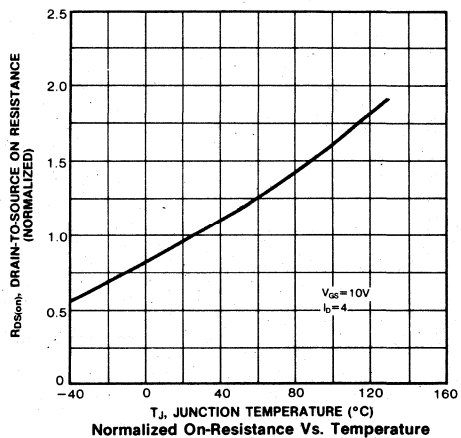
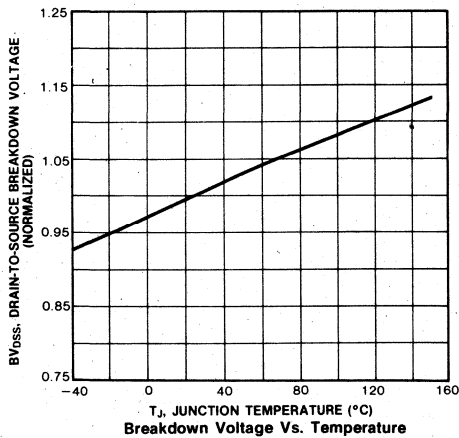
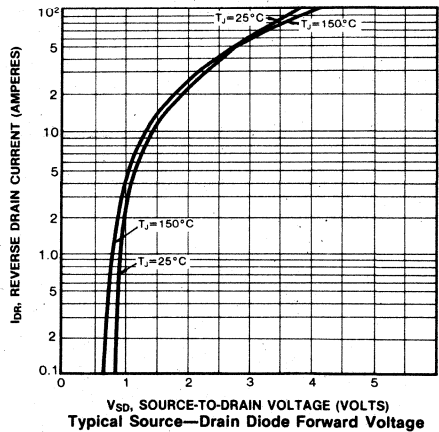
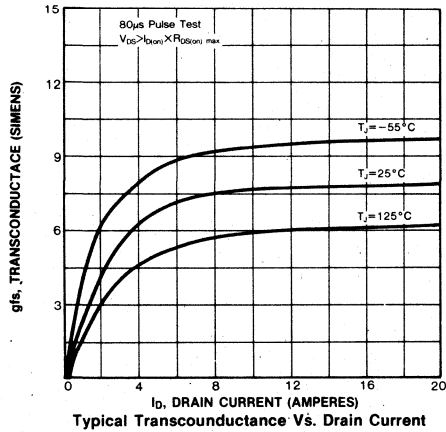
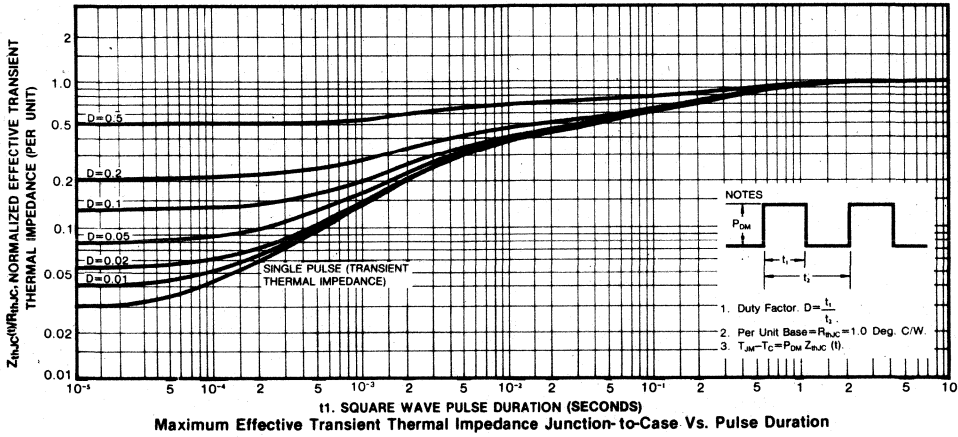

4

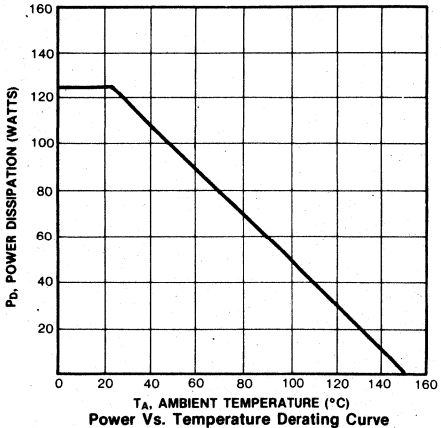
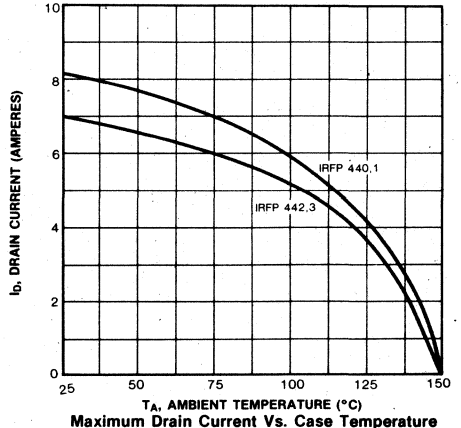
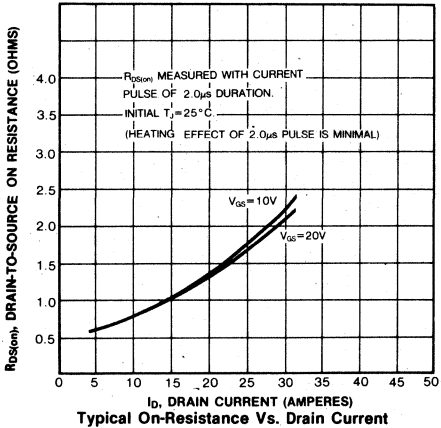
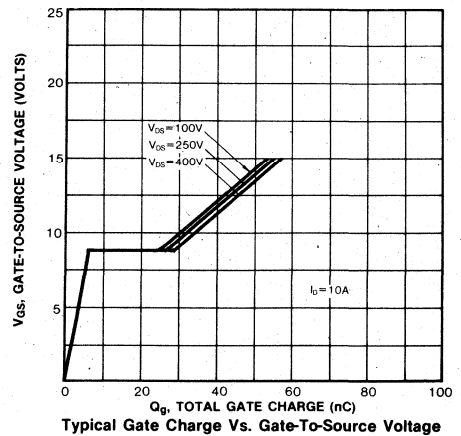
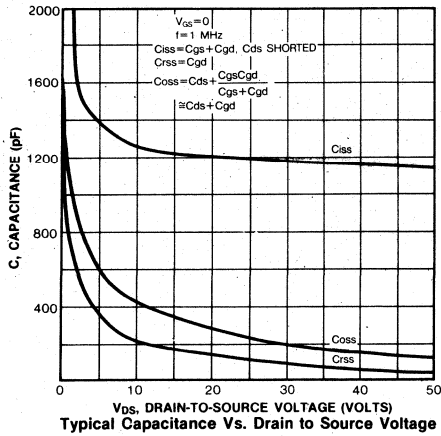

FEATURES

- Low $R_{DS(on)}$ at high voltage
- Improved inductive ruggedness
- Excellent high voltage stability
- Fast switching times
- Rugged polysilicon gate cell structure
- Low input capacitance
- Extended safe operating area
- Improved high temperature reliability
- TO-3 package (High voltage)

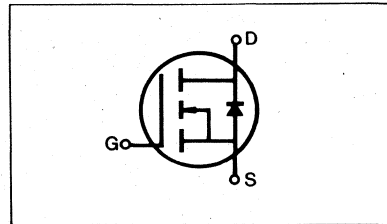
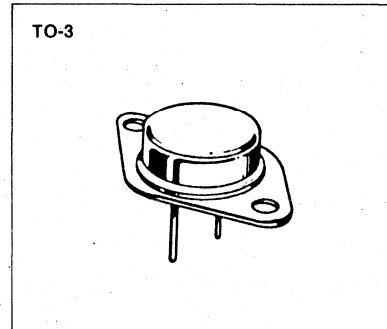

PRODUCT SUMMARY

Part Number	V_{DS}	$R_{DS(on)}$	I_D
IRF450	500V	0.4 Ω	13A
IRF451	450V	0.4 Ω	13A
IRF452	500V	0.5 Ω	12A
IRF453	450V	0.5 Ω	12A

MAXIMUM RATINGS

Characteristic	Symbol	IRF450	IRF451	IRF452	IRF453	Unit
Drain-Source Voltage (1)	V_{DSS}	500	450	500	450	Vdc
Drain-Gate Voltage ($R_{GS}=1.0M\Omega$) (1)	V_{DGR}	500	450	500	450	Vdc
Gate-Source Voltage	V_{GS}	± 20				Vdc
Continuous Drain Current $T_C=25^\circ C$	I_D	13	13	12	12	Adc
Continuous Drain Current $T_C=100^\circ C$	I_D	8.0	8.0	7.0	7.0	Adc
Drain Current—Pulsed (3)	I_{DM}	52	52	48	48	Adc
Gate Current—Pulsed	I_{GM}	± 1.5				Adc
Total Power Dissipation @ $T_C=25^\circ C$ Derate above $25^\circ C$	P_D	150 1.2				Watts W/ $^\circ C$
Operating and Storage Junction Temperature Range	T_J, T_{stg}	-55 to 150				$^\circ C$
Maximum Lead Temp. for Soldering Purposes, 1/8" from case for 5 seconds	T_L	300				$^\circ C$

- Notes: (1) $T_J=25^\circ C$ to $150^\circ C$
 (2) Pulse test: Pulse width $\leq 300\mu s$, Duty Cycle $\leq 2\%$
 (3) Repetitive rating: Pulse width limited by max. junction temperature

ELECTRICAL CHARACTERISTICS (T_C=25°C unless otherwise specified)

Characteristic	Symbol	Type	Min	Typ	Max	Units	Test Conditions
Drain-Source Breakdown Voltage	BV _{DSS}	IRF450 IRF452	500	—	—	V	V _{GS} =0V
		IRF451 IRF453	450	—	—	V	I _D =250μA
Gate Threshold Voltage	V _{GS(th)}	ALL	2.0	—	4.0	V	V _{DS} =V _{GS} , I _D =250μA
Gate-Source Leakage Forward	I _{GSS}	ALL	—	—	100	nA	V _{GS} =20V
Gate-Source Leakage Reverse	I _{GSS}	ALL	—	—	-100	nA	V _{GS} =-20V
Zero Gate Voltage Drain Current	I _{DSS}	ALL	—	—	250	μA	V _{DS} =Max. Rating, V _{GS} =0V
			—	—	1000	μA	V _{DS} =Max. Rating×0.8, V _{GS} =0V, T _C =125°C
On-State Drain-Source Current (2)	I _{D(on)}	IRF450 IRF451	13	—	—	A	V _{DS} >I _{D(on)} ×R _{DS(on) max.} , V _{GS} =10V
		IRF452 IRF453	12	—	—	A	
Static Drain-Source On-State Resistance (2)	R _{DS(on)}	IRF450 IRF451	—	0.38	0.4	Ω	V _{GS} =10V, I _D =7.0A
		IRF452 IRF453	—	0.4	0.5	Ω	
Forward Transconductance (2)	g _{fs}	ALL	6.0	10.8	—	Ω	V _{DS} >I _{D(on)} ×R _{DS(on) max.} , I _D =7.0A
Input Capacitance	C _{iss}	ALL	—	2850	3000	pF	V _{GS} =0V, V _{DS} =25V, f=1.0MHz
Output Capacitance	C _{oss}	ALL	—	350	600	pF	
Reverse Transfer Capacitance	C _{rss}	ALL	—	150	200	pF	
Turn-On Delay Time	t _{d(on)}	ALL	—	—	35	ns	V _{DD} =0.5BV _{DSS} , I _D =7.0A, Z ₀ =4.7 Ω (MOSFET switching times are essentially independent of operating temperature.)
Rise Time	t _r	ALL	—	—	50	ns	
Turn-Off Delay Time	t _{d(off)}	ALL	—	—	150	ns	
Fall Time	t _f	ALL	—	—	70	ns	
Total Gate Charge (Gate-Source Plus Gate-Drain)	Q _g	ALL	—	77	120	nC	V _{GS} =10V, I _D =16A, V _{DS} =0.8 Max. Rating (Gate charge is essentially independent of operating temperature. See Fig. 8 page 21)
Gate-Source Charge	Q _{gs}	ALL	—	11	—	nC	
Gate-Drain ("Miller") Charge	Q _{gd}	ALL	—	66	—	nC	

THERMAL RESISTANCE

Junction-to-Case	R _{thJC}	ALL	—	—	0.83	K/W	
Case-to-Sink	R _{thCS}	ALL	—	0.1	—	K/W	Mounting surface flat, smooth, and greased
Junction-to-Ambient	R _{thJA}	ALL	—	—	30	K/W	Free Air Operation

- Notes:** (1) T_J=25°C to 150°C
 (2) Pulse test: Pulse width≤300μs, Duty Cycle≤2%
 (3) Repetitive rating: Pulse width limited by max. junction temperature

SOURCE-DRAIN DIODE RATINGS AND CHARACTERISTICS

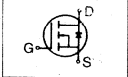
Characteristic	Symbol	Type	Min	Typ	Max	Units	Test Conditions
Continuous Source Current (Body Diode)	I_S	IRF450	—	—	13	A	Modified MOSFET symbol showing the integral reverse P-N junction rectifier 
		IRF451	—	—	12	A	
		IRF452	—	—	12	A	
		IRF453	—	—	12	A	
Pulse Source Current (Body Diode) (3)	I_{SM}	IRF450	—	—	52	A	
		IRF451	—	—	52	A	
		IRF452 IRF453	—	—	48	A	
Diode Forward Voltage (2)	V_{SD}	IRF450 IRF451	—	—	1.4	V	$T_C=25^\circ\text{C}$, $I_S=13\text{A}$, $V_{GS}=0\text{V}$
		IRF452 IRF453	—	—	1.3	V	$T_C=25^\circ\text{C}$, $I_S=12\text{A}$, $V_{GS}=0\text{V}$
Reverse Recovery Time	t_{rr}	ALL	—	1300	—	ns	$T_J=150^\circ\text{C}$, $I_F=13\text{A}$, $di_F/dt=100\text{A}/\mu\text{s}$

Notes: (1) $T_J=25^\circ\text{C}$ to 150°C (2) Pulse test: Pulse width $\leq 300\mu\text{s}$, Duty Cycle $\leq 2\%$
 (3) Repetitive rating: Pulse width limited by max. junction temperature

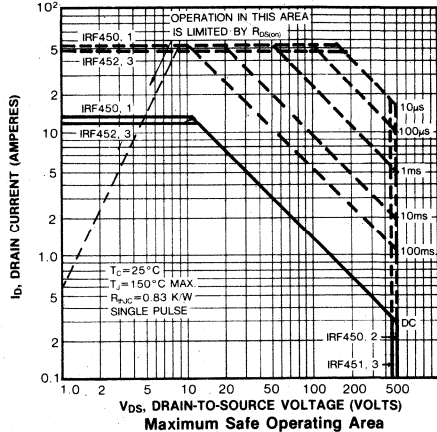
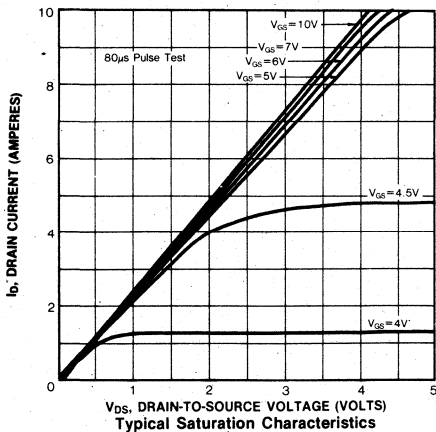
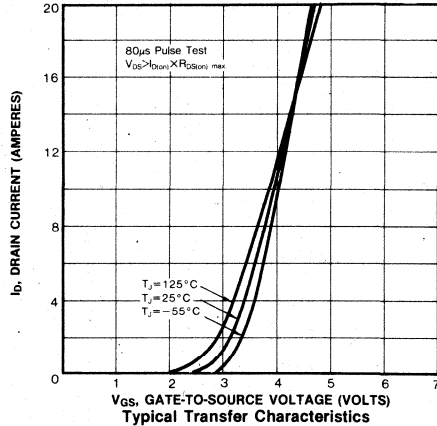
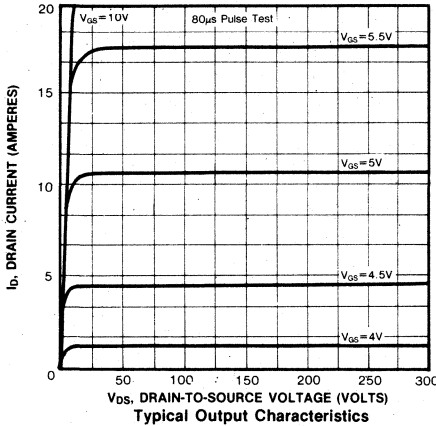

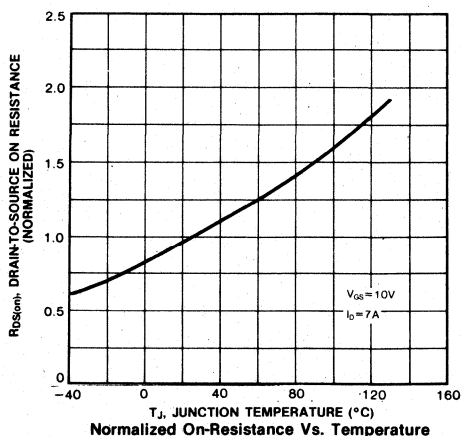
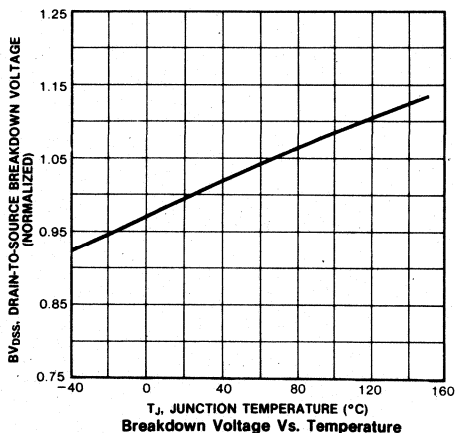
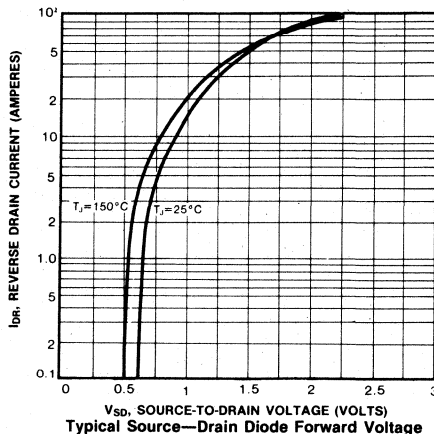
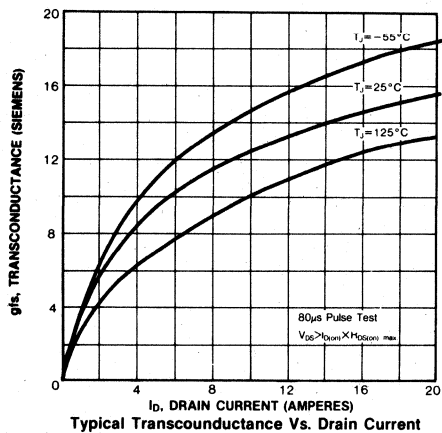
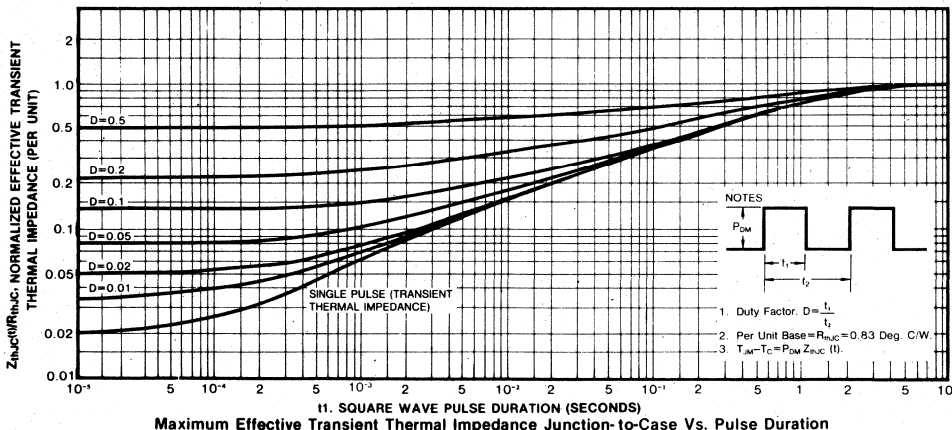

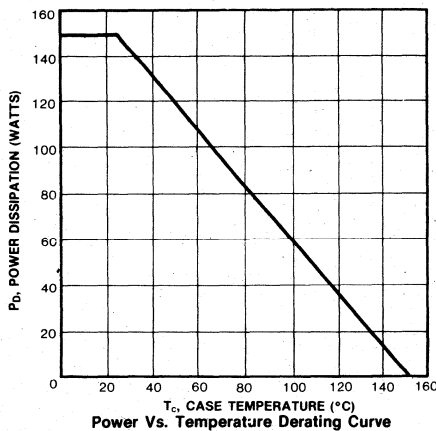
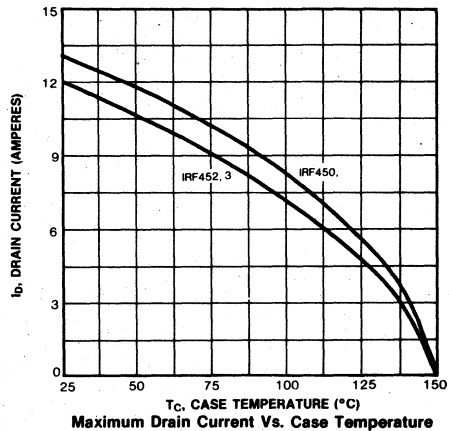
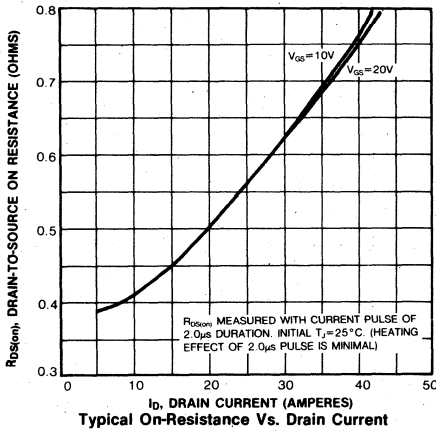
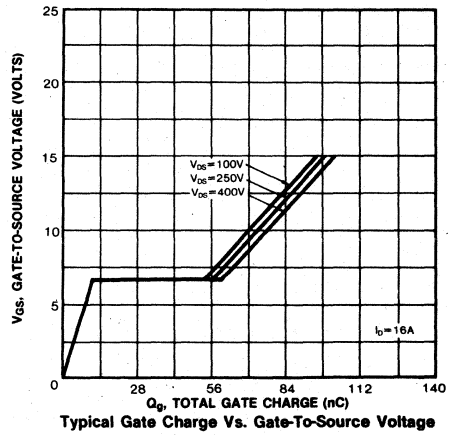
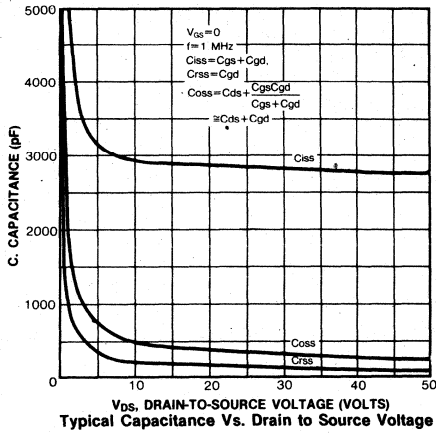

4

FEATURES

- Low $R_{DS(on)}$
- Improved inductive ruggedness
- Fast switching times
- Rugged polysilicon gate cell structure
- Low input capacitance
- Extended safe operating area
- Improved high temperature reliability
- TO-3P package

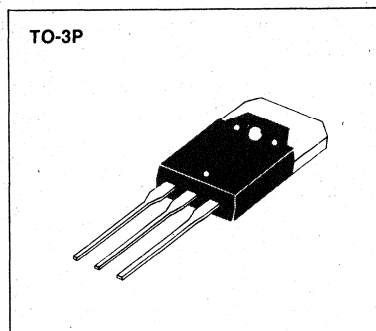

PRODUCT SUMMARY

Part Number	V_{DS}	$R_{DS(on)}$	I_D
IRFP120	100V	0.30 Ω	8.0A
IRFP121	60V	0.30 Ω	8.0A
IRFP122	100V	0.40 Ω	7.0A
IRFP123	60V	0.40 Ω	7.0A

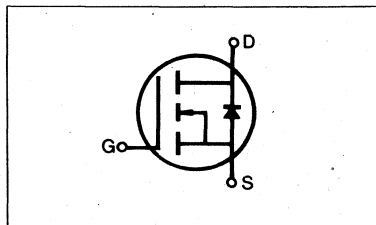

MAXIMUM RATINGS

Characteristic	Symbol	IRFP120	IRFP121	IRFP122	IRFP123	Unit
Drain-Source Voltage (1)	V_{DSS}	100	60	100	60	Vdc
Drain-Gate Voltage ($R_{GS}=1.0M\Omega$) (1)	V_{DGR}	100	60	100	60	Vdc
Gate-Source Voltage	V_{GS}	± 20				Vdc
Continuous Drain Current $T_C=25^\circ C$	I_D	8.0	8.0	7.0	7.0	Adc
Continuous Drain Current $T_C=100^\circ C$	I_B	5.0	5.0	4.0	4.0	Adc
Drain Current—Pulsed (3)	I_{DM}	32	32	28	28	Adc
Gate Current—Pulsed	I_{GM}	± 1.5				Adc
Total Power Dissipation @ $T_C=25^\circ C$ Derate above $25^\circ C$	P_D	40 0.32				Watts W/ $^\circ C$
Operating and Storage Junction Temperature Range	T_J, T_{stg}	-55 to 150				$^\circ C$
Maximum Lead Temp. for Soldering Purposes, 1/8" from case for 5 seconds	T_L	300				$^\circ C$

- Notes:** (1) $T_J=25^\circ C$ to $150^\circ C$
 (2) Pulse test: Pulse width $\leq 300\mu s$, Duty Cycle $\leq 2\%$
 (3) Repetitive rating: Pulse width limited by max. junction temperature

ELECTRICAL CHARACTERISTICS (T_C=25°C unless otherwise specified)

Characteristic	Symbol	Type	Min	Typ	Max	Units	Test Conditions
Drain-Source Breakdown Voltage	BV _{DSS}	IRFP120 IRFP122	100	—	—	V	V _{GS} =0V
		IRFP121 IRFP123	60	—	—	V	I _D =250μA
Gate Threshold Voltage	V _{GS(th)}	ALL	2.0	—	4.0	V	V _{DS} =V _{GS} , I _D =250μA
Gate-Source Leakage Forward	I _{GSS}	ALL	—	—	100	nA	V _{GS} =20V
Gate-Source Leakage Reverse	I _{GSS}	ALL	—	—	-100	nA	V _{GS} =-20V
Zero Gate Voltage Drain Current	I _{DSS}	ALL	—	—	250	μA	V _{DS} =Max. Rating, V _{GS} =0V
			—	—	1000	μA	V _{DS} =Max. Rating×0.8, V _{GS} =0V, T _C =125°C
On-State Drain-Source Current (2)	I _{D(on)}	IRFP120 IRFP121	8.0	—	—	A	V _{DS} >I _{D(on)} ×R _{DS(on)} max., V _{GS} =10V
		IRFP122 IRFP123	7.0	—	—	A	
Static Drain-Source On-State Resistance (2)	R _{DS(on)}	IRFP120 IRFP121	—	0.23	0.30	Ω	V _{GS} =10V, I _D =4.0A
		IRFP122 IRFP123	—	0.30	0.40	Ω	
Forward Transconductance (2)	g _{fs}	ALL	1.5	3.1	—		V _{DS} >I _{D(on)} ×R _{DS(on)} max., I _D =4.0A
Input Capacitance	C _{iss}	ALL	—	460	600	pF	V _{GS} =0V, V _{DS} =25V, f=1.0MHz
Output Capacitance	C _{oss}	ALL	—	220	400	pF	
Reverse Transfer Capacitance	C _{rss}	ALL	—	70	100	pF	
Turn-On Delay Time	t _{d(on)}	ALL	—	—	40	ns	V _{DD} =0.5BV _{DSS} , I _D =4.0A, Z _O =50Ω (MOSFET switching times are essentially independent of operating temperature.)
Rise Time	t _r	ALL	—	—	70	ns	
Turn-Off Delay Time	t _{d(off)}	ALL	—	—	100	ns	
Fall Time	t _f	ALL	—	—	70	ns	
Total Gate Charge (Gate-Source Plus Gate-Drain)	Q _g	ALL	—	9.8	15	nC	V _{GS} =10V, I _D =10A, V _{DS} =0.8 Max. Rating (Gate charge is essentially independent of operating temperature.)
Gate-Source Charge	Q _{gs}	ALL	—	3.5	—	nC	
Gate-Drain ("Miller") Charge	Q _{gd}	ALL	—	6.3	—	nC	

THERMAL RESISTANCE

Junction-to-Case	R _{thJC}	ALL	—	—	3.12	K/W	
Case-to-Sink	R _{thCS}	ALL	—	0.1	—	K/W	Mounting surface flat, smooth, and greased
Junction-to-Ambient	R _{thJA}	ALL	—	—	80	K/W	Free Air Operation

- Notes:** (1) T_J=25°C to 150°C
 (2) Pulse test: Pulse width≤300μs, Duty Cycle≤2%
 (3) Repetitive rating: Pulse width limited by max. junction temperature

4

SOURCE-DRAIN DIODE RATINGS AND CHARACTERISTICS

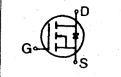
Characteristic	Symbol	Type	Min	Typ	Max	Units	Test Conditions
Continuous Source Current (Body Diode)	I_S	IRFP120	—	—	8.0	A	Modified MOSFET symbol showing the integral reverse P-N junction rectifier 
		IRFP121	—	—	7.0	A	
Pulse Source Current (Body Diode) (3)	I_{SM}	IRFP120	—	—	32	A	
		IRFP121	—	—	28	A	
Diode Forward Voltage (2)	V_{SD}	IRFP120	—	—	2.5	V	$T_C=25^\circ\text{C}$, $I_S=8.0\text{A}$, $V_{GS}=0\text{V}$
		IRFP121	—	—	2.3	V	$T_C=25^\circ\text{C}$, $I_S=7.0\text{A}$, $V_{GS}=0\text{V}$
Reverse Recovery Time	t_{rr}	ALL	—	280	—	ns	$T_J=150^\circ\text{C}$, $I_F=8.0\text{A}$, $dI_F/dt=100\text{A}/\mu\text{s}$

Notes: (1) $T_J=25^\circ\text{C}$ to 150°C (2) Pulse test: Pulse width $\leq 300\mu\text{s}$, Duty Cycle $\leq 2\%$
 (3) Repetitive rating: Pulse width limited by max. junction temperature

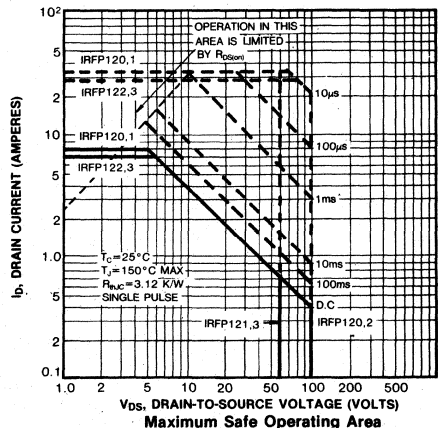
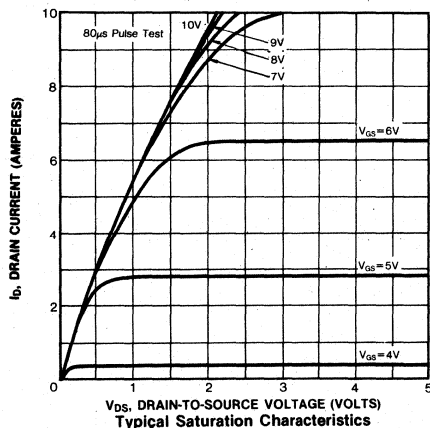
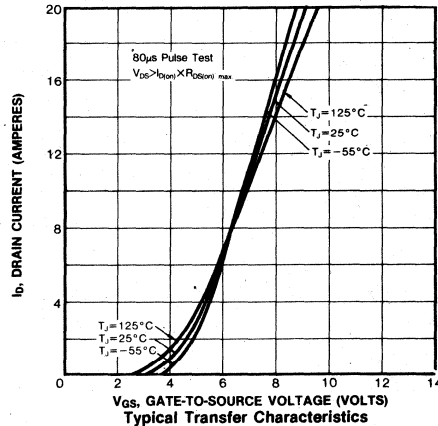
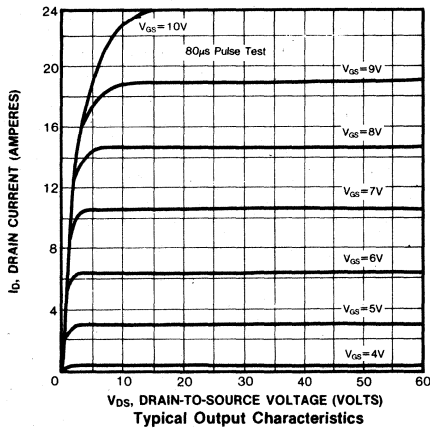

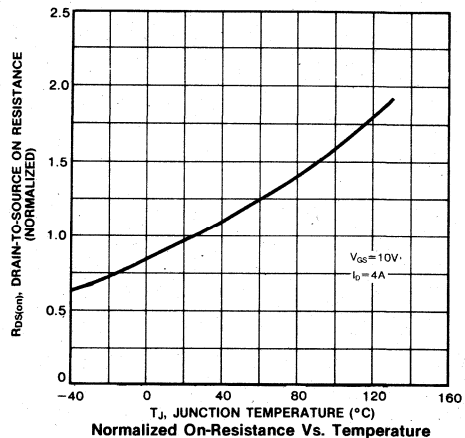
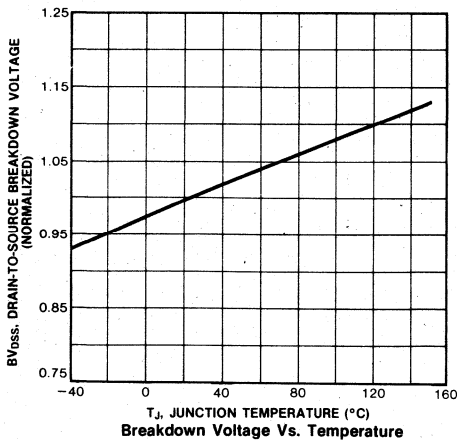
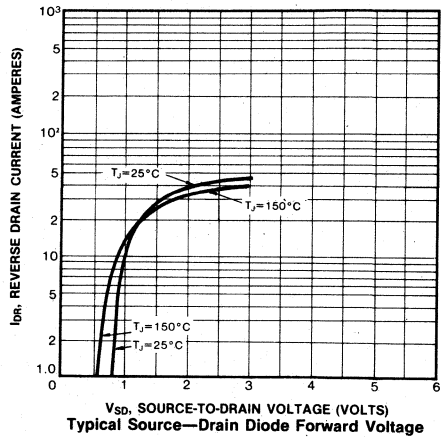
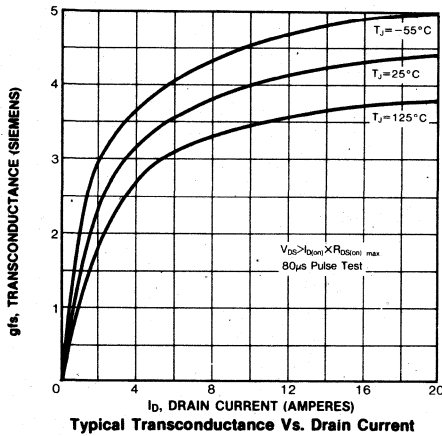
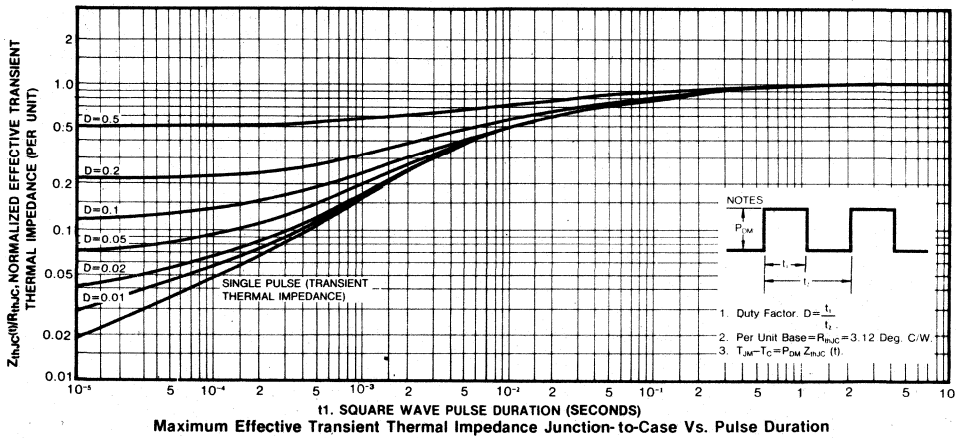

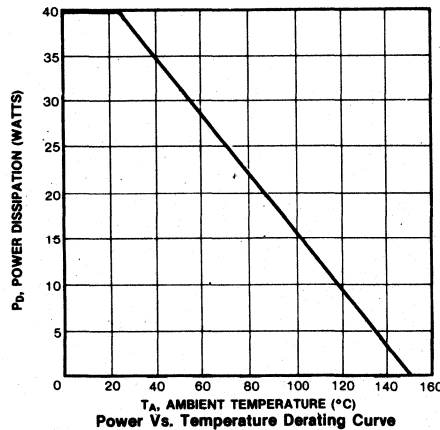
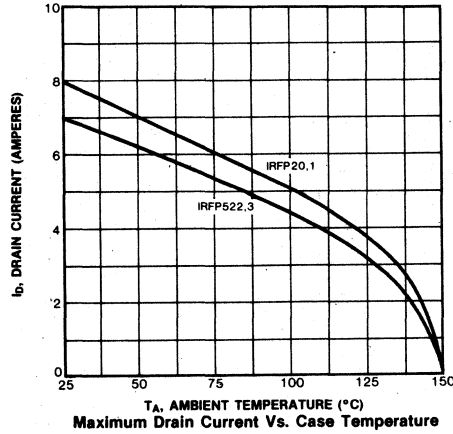
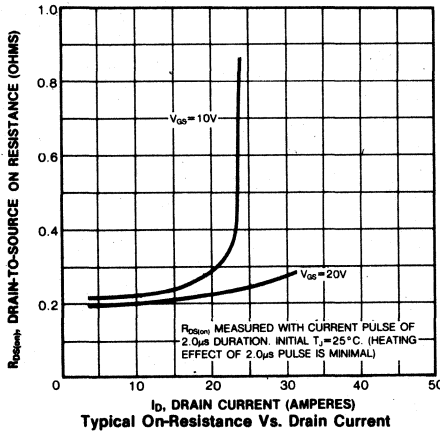
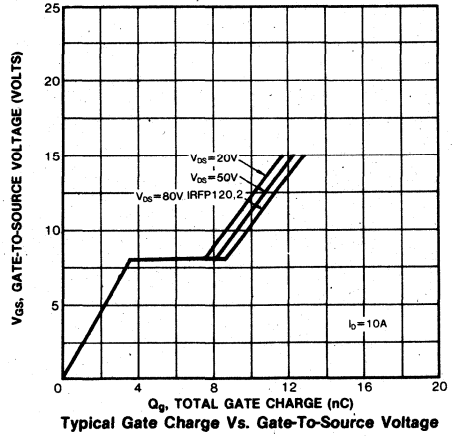
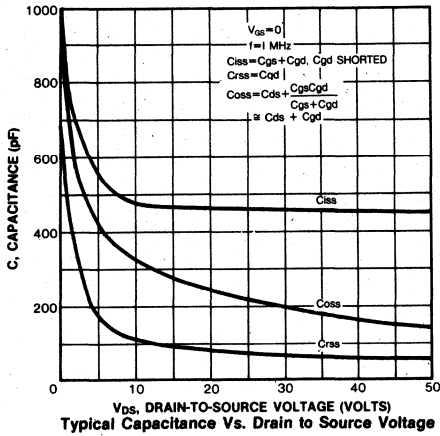

FEATURES

- Low $R_{DS(on)}$
- Improved inductive ruggedness
- Fast switching times
- Rugged polysilicon gate cell structure
- Low input capacitance
- Extended safe operating area
- Improved high temperature reliability
- TO-3P package

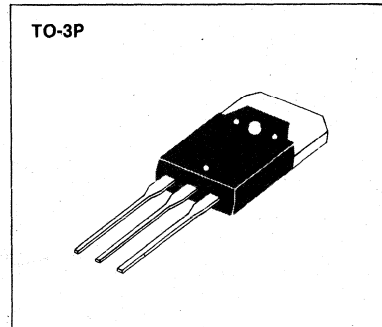

PRODUCT SUMMARY

Part Number	V_{DS}	$R_{DS(on)}$	I_D
IRFP130	100V	0.18 Ω	14A
IRFP131	60V	0.18 Ω	14A
IRFP132	100V	0.25 Ω	12A
IRFP133	60V	0.25 Ω	12A

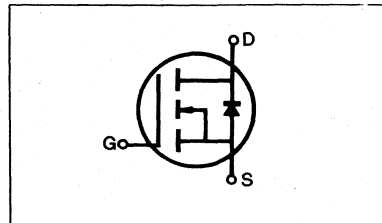

4

MAXIMUM RATINGS

Characteristic	Symbol	IRFP130	IRFP131	IRFP132	IRFP133	Unit
Drain-Source Voltage (1)	V_{DSS}	100	60	100	60	Vdc
Drain-Gate Voltage ($R_{GS}=1.0M\Omega$) (1)	V_{DGR}	100	60	100	60	Vdc
Gate-Source Voltage	V_{GS}	± 20				Vdc
Continuous Drain Current $T_C=25^\circ C$	I_D	14	14	12	12	Adc
Continuous Drain Current $T_C=100^\circ C$	I_D	9.0	9.0	8.0	8.0	Adc
Drain Current—Pulsed (3)	I_{DM}	56	56	48	48	Adc
Gate Current—Pulsed	I_{GM}	± 1.5				Adc
Total Power Dissipation @ $T_C=25^\circ C$ Derate above $25^\circ C$	P_D	75 0.6				Watts W/ $^\circ C$
Operating and Storage Junction Temperature Range	T_J, T_{stg}	-55 to 150				$^\circ C$
Maximum Lead Temp. for Soldering Purposes, 1/8" from case for 5 seconds	T_L	300				$^\circ C$

- Notes: (1) $T_J=25^\circ C$ to $150^\circ C$
 (2) Pulse test: Pulse width $\leq 300\mu s$, Duty Cycle $\leq 2\%$
 (3) Repetitive rating: Pulse width limited by max. junction temperature

ELECTRICAL CHARACTERISTICS (T_C=25°C unless otherwise specified)

Characteristic	Symbol	Type	Min	Typ	Max	Units	Test Conditions
Drain-Source Breakdown Voltage	BV _{DSS}	IRFP130 IRFP132	100	—	—	V	V _{GS} =0V
		IRFP131 IRFP133	60	—	—	V	I _D =250μA
Gate Threshold Voltage	V _{GS(th)}	ALL	2.0	—	4.0	V	V _{DS} =V _{GS} , I _D =250μA
Gate-Source Leakage Forward	I _{GSS}	ALL	—	—	100	nA	V _{GS} =20V
Gate-Source Leakage Reverse	I _{GSS}	ALL	—	—	-100	nA	V _{GS} =-20V
Zero Gate Voltage Drain Current	I _{DSS}	ALL	—	—	250	μA	V _{DS} =Max. Rating, V _{GS} =0V
			—	—	1000	μA	V _{DS} =Max. Rating×0.8, V _{GS} =0V, T _C =125°C
On-State Drain-Source Current (2)	I _{D(on)}	IRFP130 IRFP131	14	—	—	A	V _{DS} >I _{D(on)} ×R _{DS(on) max.} , V _{GS} =10V
		IRFP132 IRFP133	12	—	—	A	
Static Drain-Source On-State Resistance (2)	R _{DS(on)}	IRFP130 IRFP131	—	0.10	0.18	Ω	V _{GS} =10V, I _D =8.0A
		IRFP132 IRFP133	—	0.20	0.25	Ω	
Forward Transconductance (2)	g _{fs}	ALL	4.0	5.5	—	Ω	V _{DS} >I _{D(on)} ×R _{DS(on) max.} , I _D =8.0A
Input Capacitance	C _{iss}	ALL	—	680	800	pF	V _{GS} =0V, V _{DS} =25V, f=1.0MHz V _{DD} =0.5BV _{DSS} , I _D =8.0A, Z ₀ =15 (MOSFET switching times are essentially independent of operating temperature.)
Output Capacitance	C _{oss}	ALL	—	300	500	pF	
Reverse Transfer Capacitance	C _{rss}	ALL	—	100	150	pF	
Turn-On Delay Time	t _{d(on)}	ALL	—	—	30	ns	
Rise Time	t _r	ALL	—	—	75	ns	
Turn-Off Delay Time	t _{d(off)}	ALL	—	—	40	ns	
Fall Time	t _f	ALL	—	—	45	ns	
Total Gate Charge (Gate-Source Plus Gate-Drain)	Q _g	ALL	—	18	30	nC	V _{GS} =10V, I _D =18A, V _{DS} =0.8 Max. Rating (Gate charge is essentially independent of operating temperature.)
Gate-Source Charge	Q _{gs}	ALL	—	6.0	—	nC	
Gate-Drain ("Miller") Charge	Q _{gd}	ALL	—	12.0	—	nC	

THERMAL RESISTANCE

Junction-to-Case	R _{thJC}	ALL	—	—	1.67	K/W	
Case-to-Sink	R _{thCS}	ALL	—	0.1	—	K/W	Mounting surface flat, smooth, and greased
Junction-to-Ambient	R _{thJA}	ALL	—	—	80	K/W	Free Air Operation

- Notes: (1) T_J=25°C to 150°C
 (2) Pulse test: Pulse width≤300μs, Duty Cycle≤2%
 (3) Repetitive rating: Pulse width limited by max. junction temperature

SOURCE-DRAIN DIODE RATINGS AND CHARACTERISTICS

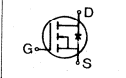
Characteristic	Symbol	Type	Min	Typ	Max	Units	Test Conditions
Continuous Source Current (Body Diode)	I_S	IRFP130	—	—	14	A	Modified MOSFET symbol showing the integral reverse P-N junction rectifier 
		IRFP131	—	—	12	A	
		IRFP132	—	—	12	A	
		IRFP133	—	—	12	A	
Pulse Source Current (Body Diode) (3)	I_{SM}	IRFP130	—	—	56	A	
		IRFP131	—	—	48	A	
		IRFP132	—	—	48	A	
		IRFP133	—	—	48	A	
Diode Forward Voltage (2)	V_{SD}	IRFP130	—	—	2.5	V	$T_C=25^\circ\text{C}$, $I_S=14\text{A}$, $V_{GS}=0\text{V}$
		IRFP131	—	—	2.5	V	$T_C=25^\circ\text{C}$, $I_S=12\text{A}$, $V_{GS}=0\text{V}$
		IRFP132	—	—	2.3	V	$T_C=25^\circ\text{C}$, $I_S=12\text{A}$, $V_{GS}=0\text{V}$
		IRFP133	—	—	2.3	V	$T_C=25^\circ\text{C}$, $I_S=12\text{A}$, $V_{GS}=0\text{V}$
Reverse Recovery Time	t_{rr}	ALL	—	360	—	ns	$T_J=150^\circ\text{C}$, $I_F=14\text{A}$, $dI_F/dt=100\text{A}/\mu\text{s}$

Notes: (1) $T_J=25^\circ\text{C}$ to 150°C (2) Pulse test: Pulse width $\leq 300\mu\text{s}$, Duty Cycle $\leq 2\%$
 (3) Repetitive rating: Pulse width limited by max. junction temperature

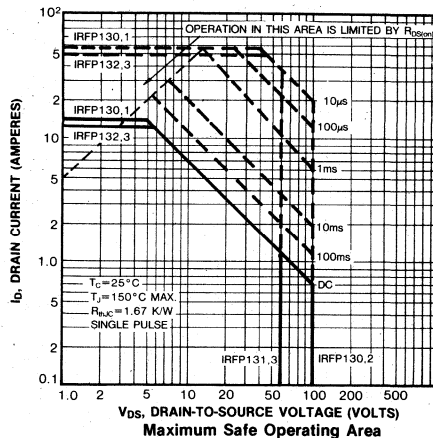
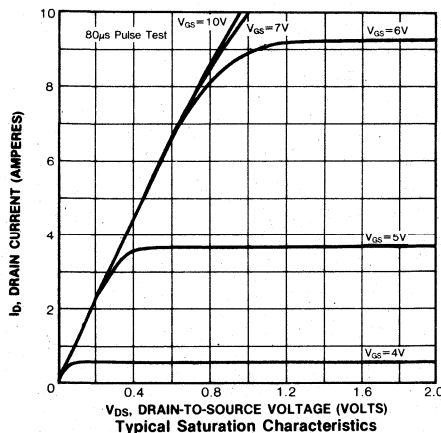
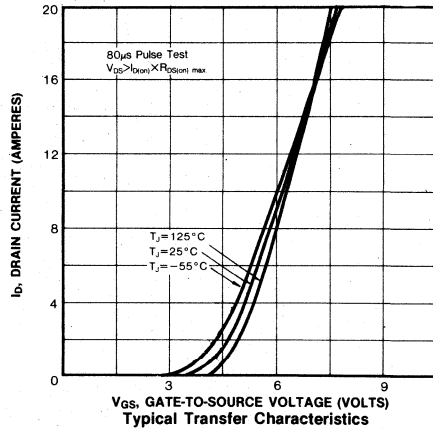
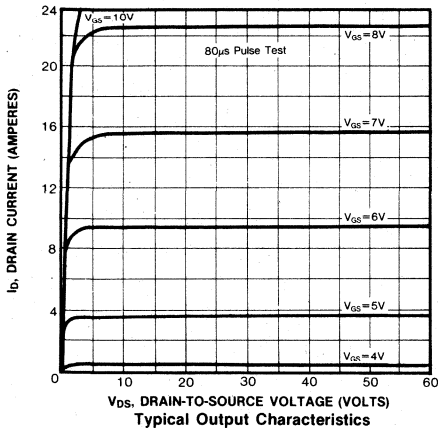

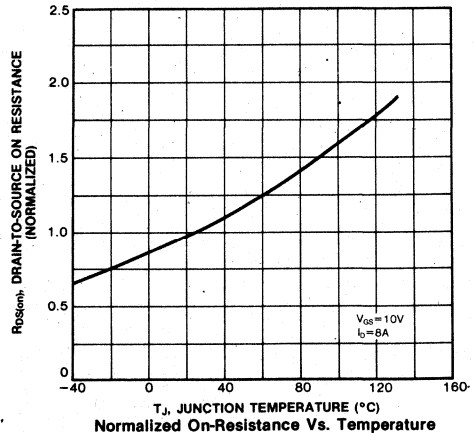
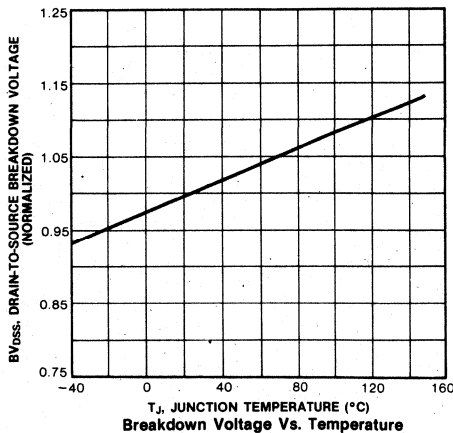
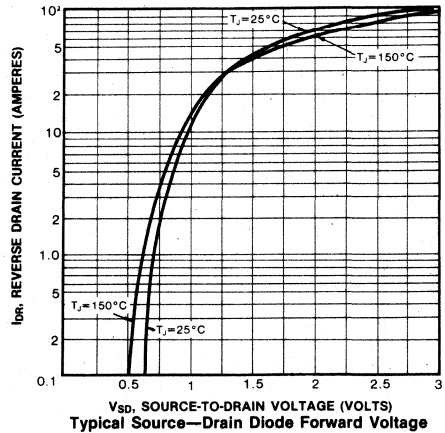
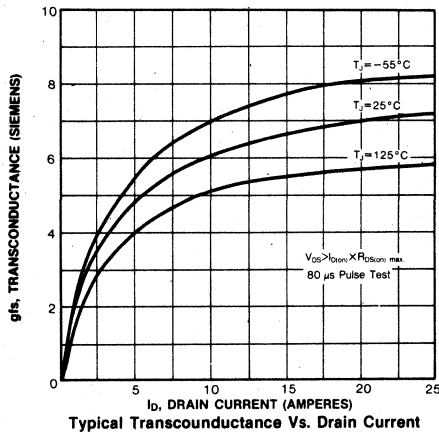
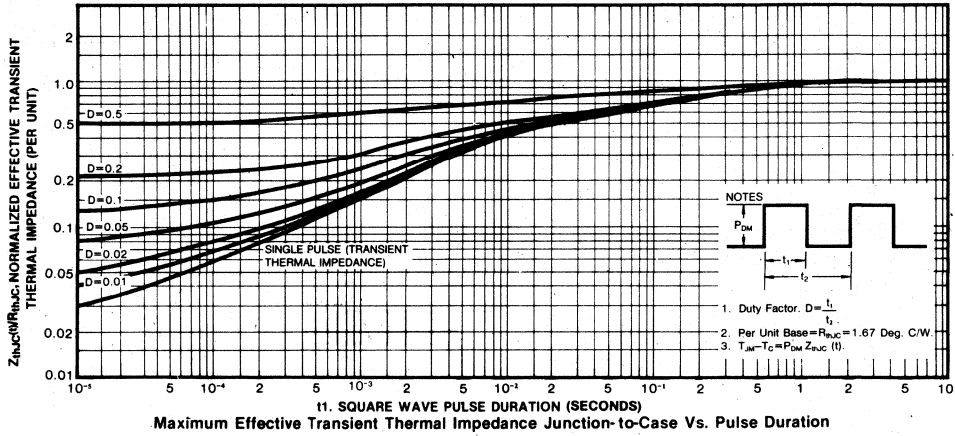

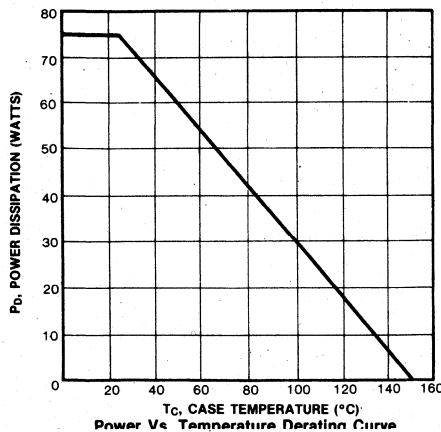
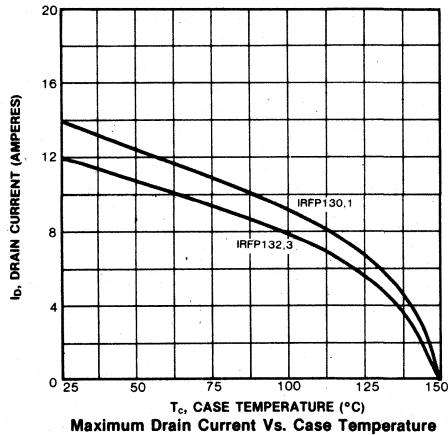
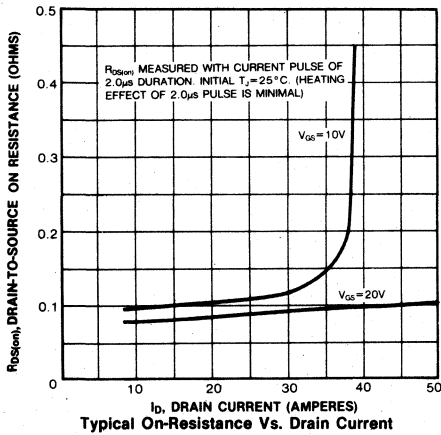
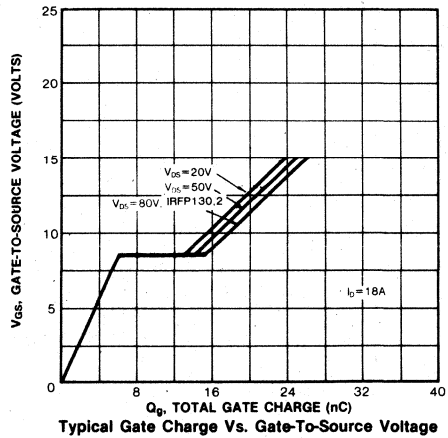
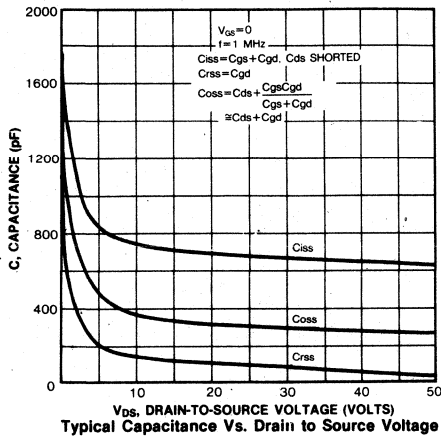

4

FEATURES

- Low $R_{DS(on)}$
- Improved inductive ruggedness
- Fast switching times
- Rugged polysilicon gate cell structure
- Low input capacitance
- Extended safe operating area
- Improved high temperature reliability
- TO-3P package

PRODUCT SUMMARY

Part Number	V_{DS}	$R_{DS(on)}$	I_D
IRFP140	100V	0.085 Ω	27A
IRFP141	60V	0.085 Ω	27A
IRFP142	100V	0.11 Ω	24A
IRFP143	60V	0.11 Ω	24A

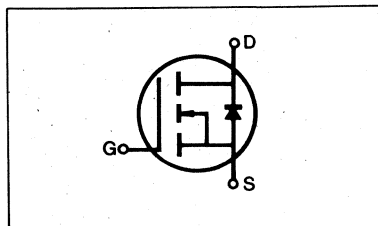
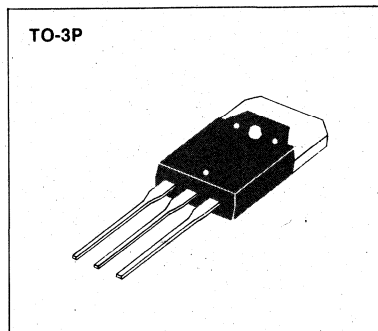

MAXIMUM RATINGS

Characteristic	Symbol	IRFP140	IRFP141	IRFP142	IRFP143	Unit
Drain-Source Voltage (1)	V_{DSS}	100	60	100	60	Vdc
Drain-Gate Voltage ($R_{GS}=1.0M\Omega$) (1)	V_{DGR}	100	60	100	60	Vdc
Gate-Source Voltage	V_{GS}	± 20				Vdc
Continuous Drain Current $T_C=25^\circ C$	I_D	27	27	24	24	Adc
Continuous Drain Current $T_C=100^\circ C$	I_D	17	17	15	15	Adc
Drain Current—Pulsed (3)	I_{DM}	108	108	96	96	Adc
Gate Current—Pulsed	I_{GM}	± 1.5				Adc
Total Power Dissipation @ $T_C=25^\circ C$ Derate above $25^\circ C$	P_D	125 1.0				Watts W/ $^\circ C$
Operating and Storage Junction Temperature Range	T_J, T_{stg}	-55 to 150				$^\circ C$
Maximum Lead Temp. for Soldering Purposes, 1/8" from case for 5 seconds	T_L	300				$^\circ C$

- Notes:** (1) $T_J=25^\circ C$ to $150^\circ C$
 (2) Pulse test: Pulse width $\leq 300\mu s$, Duty Cycle $\leq 2\%$
 (3) Repetitive rating: Pulse width limited by max. junction temperature

ELECTRICAL CHARACTERISTICS (T_C=25°C unless otherwise specified)

Characteristic	Symbol	Type	Min	Typ	Max	Units	Test Conditions
Drain-Source Breakdown Voltage	BV _{DSS}	IRFP140 IRFP142	100	—	—	V	V _{GS} =0V
		IRFP141 IRFP143	60	—	—	V	I _D =250μA
Gate Threshold Voltage	V _{GS(th)}	ALL	2.0	—	4.0	V	V _{DS} =V _{GS} , I _D =250μA
Gate-Source Leakage Forward	I _{GSS}	ALL	—	—	100	nA	V _{GS} =20V
Gate-Source Leakage Reverse	I _{GSS}	ALL	—	—	-100	nA	V _{GS} =-20V
Zero Gate Voltage Drain Current	I _{DSS}	ALL	—	—	250	μA	V _{DS} =Max. Rating, V _{GS} =0V
			—	—	1000	μA	V _{DS} =Max. Rating×0.8, V _{GS} =0V, T _C =125°C
On-State Drain-Source Current (2)	I _{D(on)}	IRFP140 IRFP141	27	—	—	A	V _{DS} >I _{D(on)} ×R _{DS(on) max.} , V _{GS} =10V
		IRFP142 IRFP143	24	—	—	A	
Static Drain-Source On-State Resistance (2)	R _{DS(on)}	IRFP140 IRFP141	—	0.06	0.085	Ω	V _{GS} =10V, I _D =15A
		IRFP142 IRFP143	—	0.09	0.11	Ω	
Forward Transconductance (2)	g _{fs}	ALL	6.0	10.5	—	ŧ	V _{DS} >I _{D(on)} ×R _{DS(on) max.} , I _D =15A
Input Capacitance	C _{iss}	ALL	—	1320	1600	pF	V _{GS} =0V, V _{DS} =25V, f=1.0MHz
Output Capacitance	C _{oss}	ALL	—	600	800	pF	
Reverse Transfer Capacitance	C _{rss}	ALL	—	250	300	pF	
Turn-On Delay Time	t _{d(on)}	ALL	—	—	30	ns	V _{DD} =0.5BV _{DSS} , I _D =15A, Z _O =4.7 Ω (MOSFET switching times are essentially independent of operating temperature.)
Rise Time	t _r	ALL	—	—	60	ns	
Turn-Off Delay Time	t _{d(off)}	ALL	—	—	80	ns	
Fall Time	t _f	ALL	—	—	30	ns	
Total Gate Charge (Gate-Source Plus Gate-Drain)	Q _g	ALL	—	39	60	nC	V _{GS} =10V, I _D =34A, V _{DS} =0.8 Max. Rating (Gate charge is essentially independent of operating temperature.)
Gate-Source Charge	Q _{gs}	ALL	—	12	—	nC	
Gate-Drain ("Miller") Charge	Q _{gd}	ALL	—	27	—	nC	

THERMAL RESISTANCE

Junction-to-Case	R _{thJC}	ALL	—	—	1.0	K/W	
Case-to-Sink	R _{thCS}	ALL	—	0.1	—	K/W	Mounting surface flat, smooth, and greased
Junction-to-Ambient	R _{thJA}	ALL	—	—	80	K/W	Free Air Operation

- Notes:** (1) T_J=25°C to 150°C
 (2) Pulse test: Pulse width≤300μs, Duty Cycle≤2%
 (3) Repetitive rating: Pulse width limited by max. junction temperature

SOURCE-DRAIN DIODE RATINGS AND CHARACTERISTICS

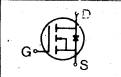
Characteristic	Symbol	Type	Min	Typ	Max	Units	Test Conditions
Continuous Source Current (Body Diode)	I _S	IRFP140 IRFP141	—	—	27	A	Modified MOSFET symbol showing the integral reverse P-N junction rectifier 
		IRFP142 IRFP143	—	—	24	A	
Pulse Source Current (Body Diode) (3)	I _{SM}	IRFP140 IRFP141	—	—	108	A	
		IRFP142 IRFP143	—	—	96	A	
Diode Forward Voltage (2)	V _{SD}	IRFP140 IRFP141	—	—	2.5	V	T _C = 25°C, I _S = 27A, V _{GS} = 0V
		IRFP142 IRFP143	—	—	2.3	V	T _C = 25°C, I _S = 24A, V _{GS} = 0V
Reverse Recovery Time	t _{rr}	ALL	—	500	—	ns	T _J = 150°C, I _F = 27A, dI _F /dt = 100A/μs

Notes: (1) T_J = 25°C to 150°C (2) Pulse test: Pulse width ≤ 300μs, Duty Cycle ≤ 2% (3) Repetitive rating: Pulse width limited by max. junction temperature

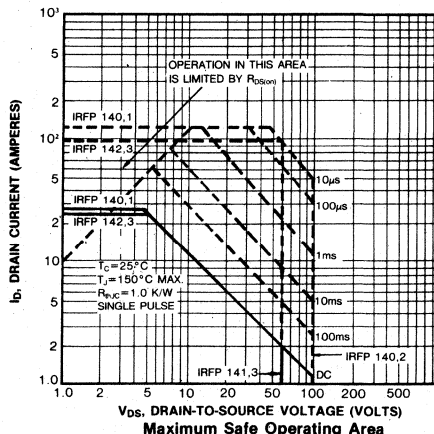
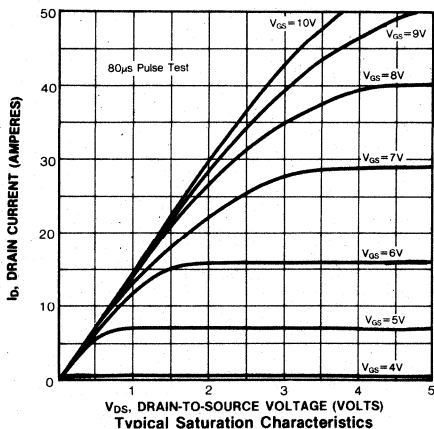
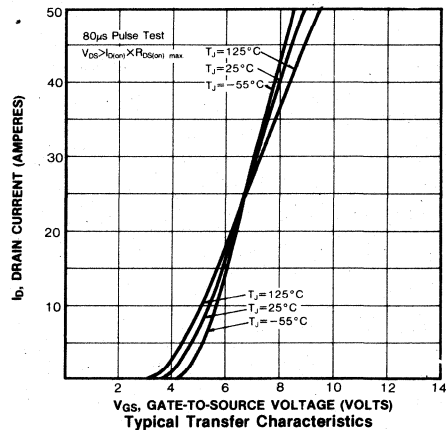
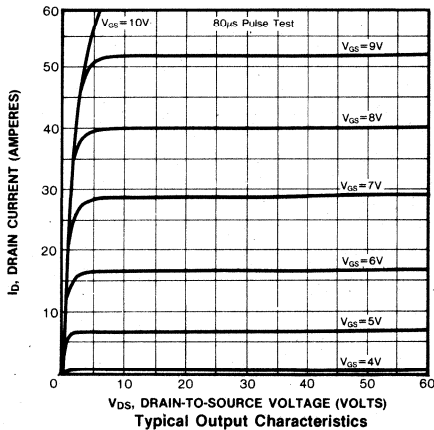

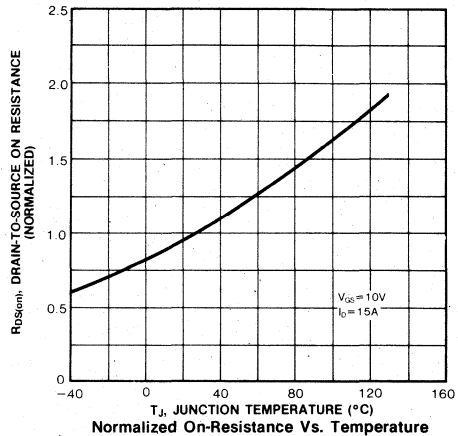
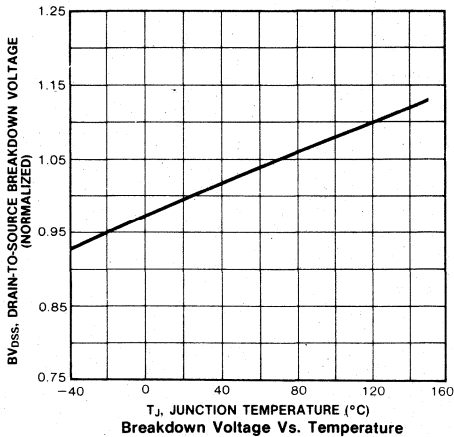
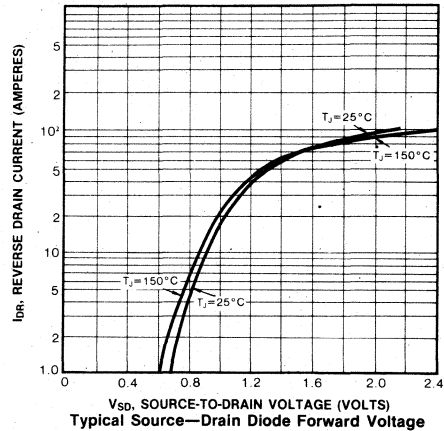
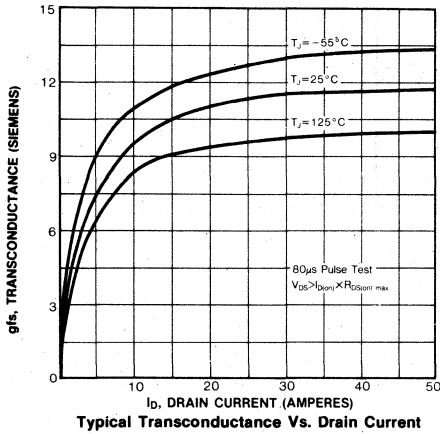
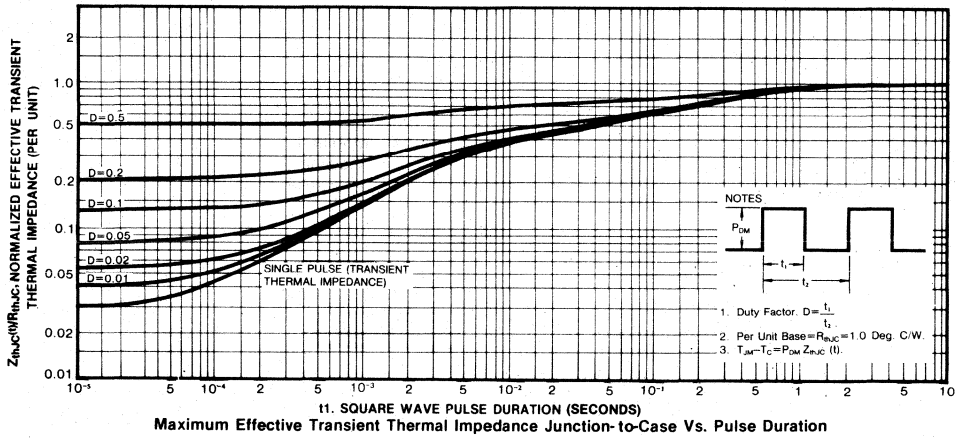

IRFP140/141/142/143

N-CHANNEL POWER MOSFETS

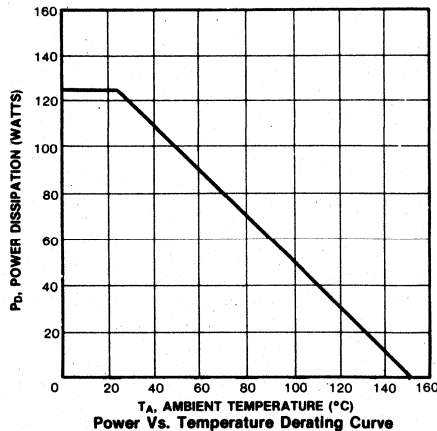
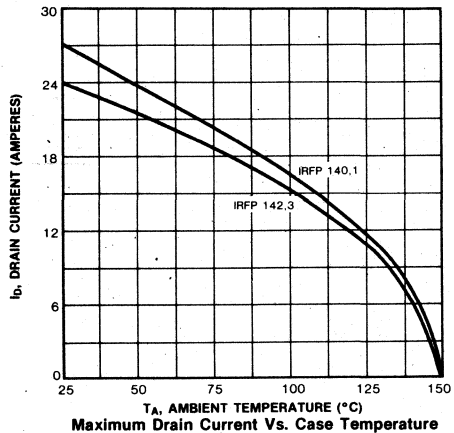
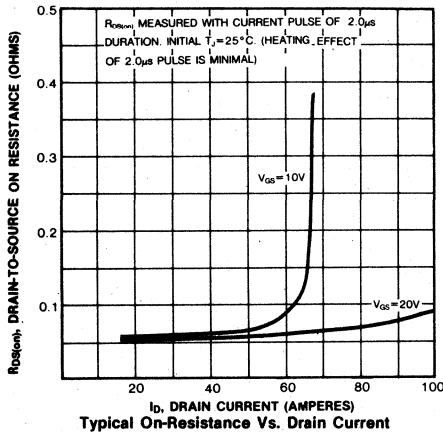
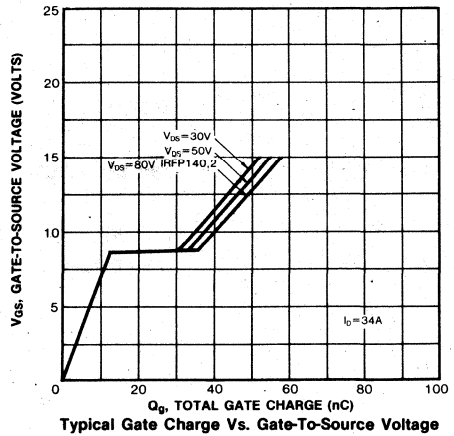
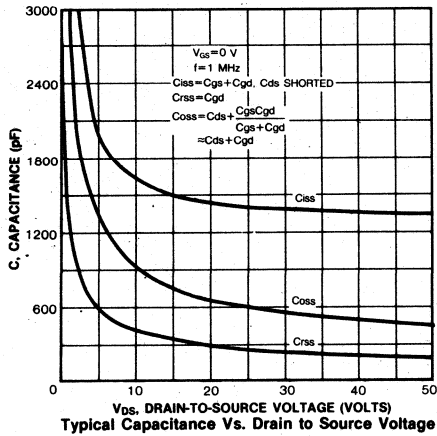

FEATURES

- Low $R_{DS(on)}$
- Improved inductive ruggedness
- Fast switching times
- Rugged polysilicon gate cell structure
- Low input capacitance
- Extended safe operating area
- Improved high temperature reliability
- TO-3P package

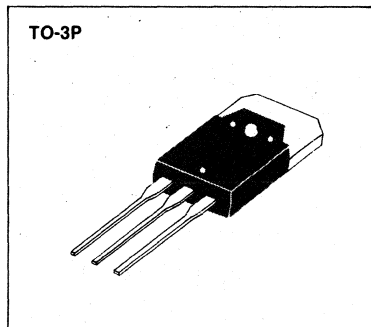

PRODUCT SUMMARY

Part Number	V_{DS}	$R_{DS(on)}$	I_D
IRFP150	100V	0.055 Ω	40A
IRFP151	60V	0.055 Ω	40A
IRFP152	100V	0.08 Ω	33A
IRFP153	60V	0.08 Ω	33A

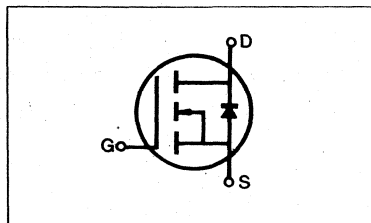

MAXIMUM RATINGS

Characteristic	Symbol	IRFP150	IRFP151	IRFP152	IRFP153	Unit
Drain-Source Voltage (1)	V_{DSS}	100	60	100	60	Vdc
Drain-Gate Voltage ($R_{GS}=1.0M\Omega$) (1)	V_{DGR}	100	60	100	60	Vdc
Gate-Source Voltage	V_{GS}	± 20				Vdc
Continuous Drain Current $T_C=25^\circ C$	I_D	40	40	33	33	Adc
Continuous Drain Current $T_C=100^\circ C$	I_D	25	25	20	20	Adc
Drain Current—Pulsed (3)	I_{DM}	160	160	132	132	Adc
Gate Current—Pulsed	I_{GM}	± 1.5				Adc
Total Power Dissipation @ $T_C=25^\circ C$ Derate above $25^\circ C$	P_D	150 1.2				Watts W/ $^\circ C$
Operating and Storage Junction Temperature Range	T_J, T_{stg}	-55 to 150				$^\circ C$
Maximum Lead Temp. for Soldering Purposes, 1/8" from case for 5 seconds	T_L	300				$^\circ C$

Notes: (1) $T_J=25^\circ C$ to $150^\circ C$

(2) Pulse test: Pulse width $\leq 300\mu s$, Duty Cycle $\leq 2\%$

(3) Repetitive rating: Pulse width limited by max. junction temperature.

ELECTRICAL CHARACTERISTICS (T_C=25 °C unless otherwise specified)

Characteristic	Symbol	Type	Min	Typ	Max	Units	Test Conditions
Drain-Source Breakdown Voltage	BV _{DSS}	IRFP150 IRFP152	100	—	—	V	V _{GS} =0V
		IRFP151 IRFP153	60	—	—	V	I _D =250μA
Gate Threshold Voltage	V _{GS(th)}	ALL	2.0	—	4.0	V	V _{DS} =V _{GS} , I _D =250μA
Gate-Source Leakage Forward	I _{GSS}	ALL	—	—	100	nA	V _{GS} =20V
Gate-Source Leakage Reverse	I _{GSS}	ALL	—	—	-100	nA	V _{GS} =-20V
Zero Gate Voltage Drain Current	I _{DSS}	ALL	—	—	250	μA	V _{DS} =Max. Rating, V _{GS} =0V
			—	—	1000	μA	V _{DS} =Max. Rating×0.8, V _{GS} =0V, T _C =125 °C
On-State Drain-Source Current (2)	I _{D(on)}	IRFP150 IRFP151	40	—	—	A	V _{DS} >I _{D(on)} ×R _{DS(on) max.} , V _{GS} =10V
		IRFP152 IRFP153	33	—	—	A	
Static Drain-Source On-State Resistance (2)	R _{DS(on)}	IRFP150 IRFP151	—	0.04	0.055	Ω	V _{GS} =10V, I _D =20A
		IRFP152 IRFP153	—	0.06	0.08	Ω	
Forward Transconductance (2)	g _{fs}	ALL	9.0	12.3	—	∅	V _{DS} >I _{D(on)} ×R _{DS(on) max.} , I _D =20A
Input Capacitance	C _{ISS}	ALL	—	2900	3000	pF	V _{GS} =0V, V _{DS} =25V, f=1.0MHz
Output Capacitance	C _{OSS}	ALL	—	1050	1500	pF	
Reverse Transfer Capacitance	C _{rss}	ALL	—	450	500	pF	
Turn-On Delay Time	t _{d(on)}	ALL	—	—	35	ns	V _{DD} =0.5BV _{DSS} , I _D =20A, Z _O =4.7 Ω (MOSFET switching times are essentially independent of operating temperature.)
Rise Time	t _r	ALL	—	—	100	ns	
Turn-Off Delay Time	t _{d(off)}	ALL	—	—	125	ns	
Fall Time	t _f	ALL	—	—	100	ns	
Total Gate Charge (Gate-Source Plus Gate-Drain)	Q _g	ALL	—	72	120	nC	V _{GS} =10V, I _D =50A, V _{DS} =0.8 Max. Rating (Gate charge is essentially independent of operating temperature.)
Gate-Source Charge	Q _{gs}	ALL	—	18	—	nC	
Gate-Drain ("Miller") Charge	Q _{gd}	ALL	—	54	—	nC	

THERMAL RESISTANCE

Junction-to-Case	R _{thJC}	ALL	—	—	0.83	K/W	
Case-to-Sink	R _{thCS}	ALL	—	0.1	—	K/W	Mounting surface flat, smooth, and greased
Junction-to-Ambient	R _{thJA}	ALL	—	—	30	K/W	Free Air Operation

- Notes:** (1) T_J=25 °C to 150 °C
 (2) Pulse test: Pulse width ≤ 300 μs, Duty Cycle ≤ 2%
 (3) Repetitive rating: Pulse width limited by max. junction temperature

SOURCE-DRAIN DIODE RATINGS AND CHARACTERISTICS

Characteristic	Symbol	Type	Min	Typ	Max	Units	Test Conditions
Continuous Source Current (Body Diode)	I_S	IRFP150	—	—	40	A	Modified MOSFET symbol showing the integral reverse P-N junction rectifier 
		IRFP151	—	—	40	A	
		IRFP152	—	—	33	A	
		IRFP153	—	—	33	A	
Pulse Source Current (Body Diode) (3)	I_{SM}	IRFP150	—	—	160	A	
		IRFP151	—	—	160	A	
		IRFP152	—	—	132	A	
		IRFP153	—	—	132	A	
Diode Forward Voltage (2)	V_{SD}	IRFP150	—	—	2.5	V	$T_C=25^\circ\text{C}$, $I_S=40\text{A}$, $V_{GS}=0\text{V}$
		IRFP151	—	—	2.5	V	$T_C=25^\circ\text{C}$, $I_S=40\text{A}$, $V_{GS}=0\text{V}$
		IRFP152	—	—	2.3	V	$T_C=25^\circ\text{C}$, $I_S=33\text{A}$, $V_{GS}=0\text{V}$
IRFP153	—	—	2.3	V	$T_C=25^\circ\text{C}$, $I_S=33\text{A}$, $V_{GS}=0\text{V}$		
Reverse Recovery Time	t_{rr}	ALL	—	600	—	ns	$T_J=150^\circ\text{C}$, $I_F=40\text{A}$, $dI_F/dt=100\text{A}/\mu\text{s}$

Notes: (1) $T_J=25^\circ\text{C}$ to 150°C (2) Pulse test: Pulse width $\leq 300\mu\text{s}$, Duty Cycle $\leq 2\%$
 (3) Repetitive rating: Pulse width limited by max. junction temperature

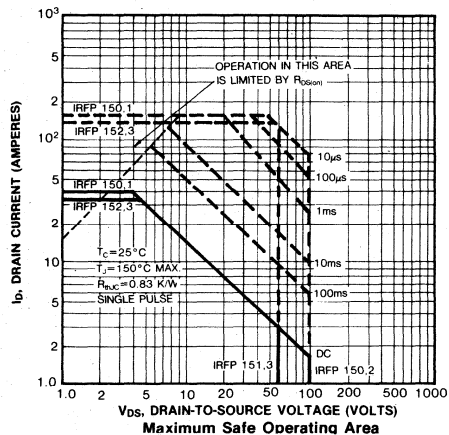
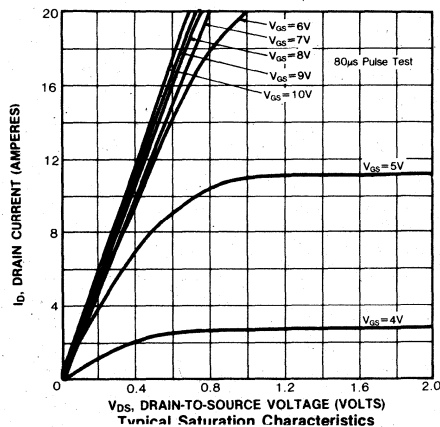
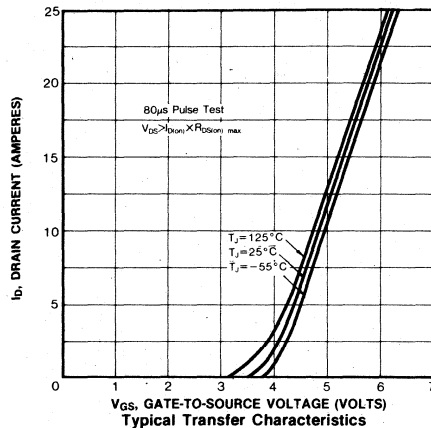
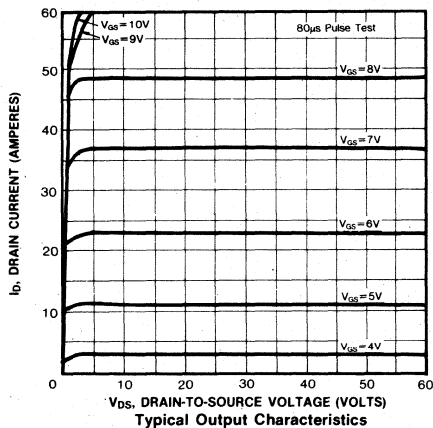

4

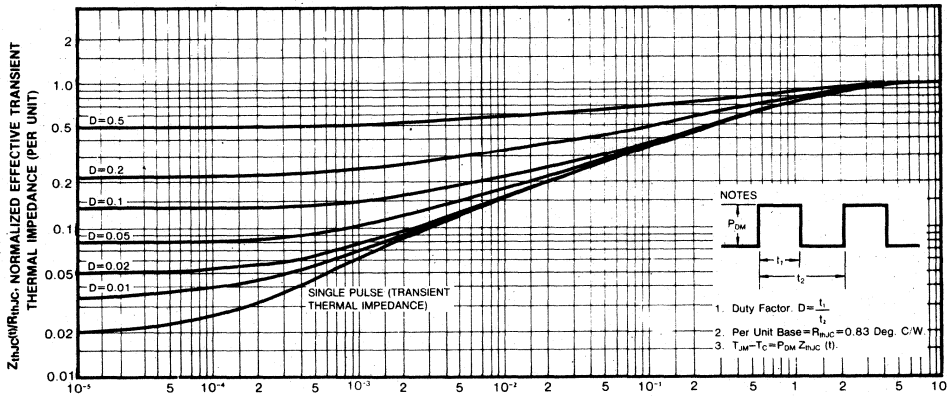

11. SQUARE WAVE PULSE DURATION (SECONDS)
Maximum Effective Transient Thermal Impedance Junction-to-Case Vs. Pulse Duration

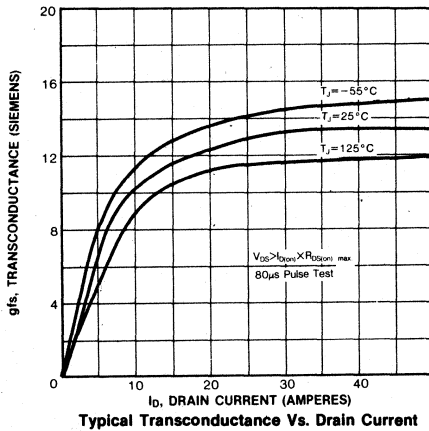

Typical Transconductance Vs. Drain Current

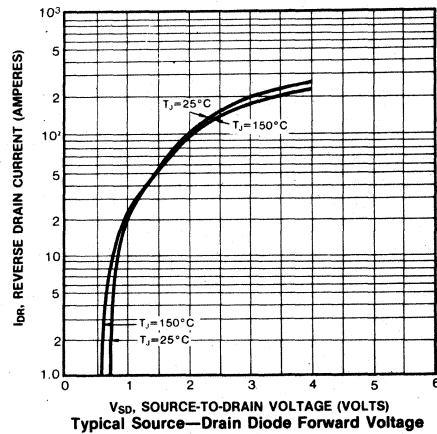

Typical Source-Drain Diode Forward Voltage

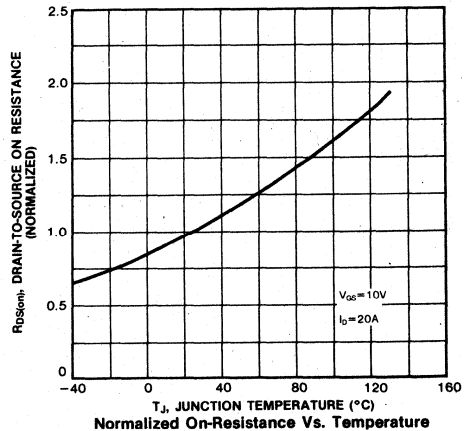
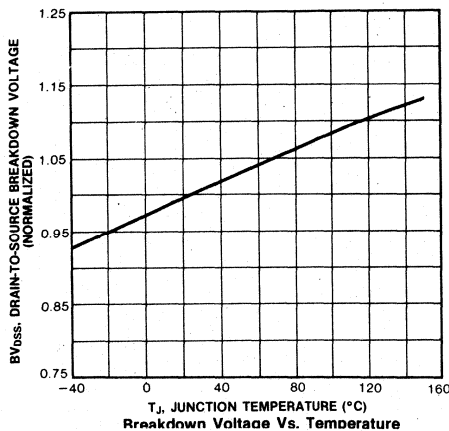

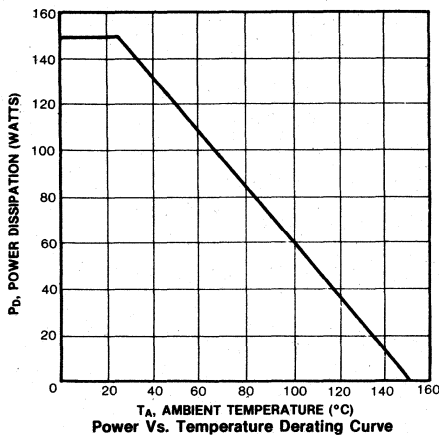
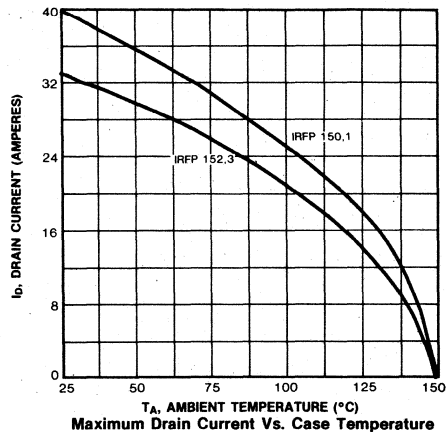
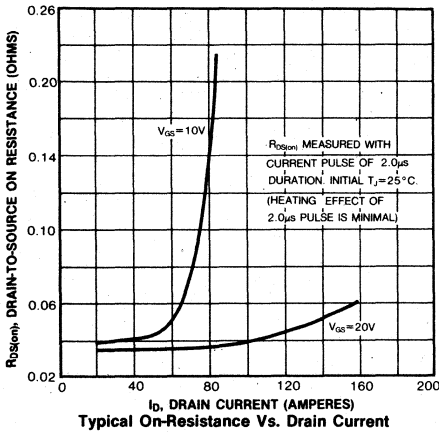
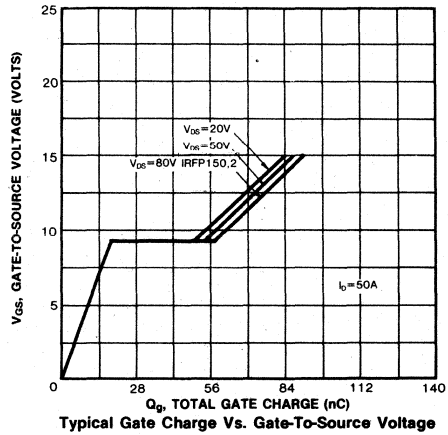
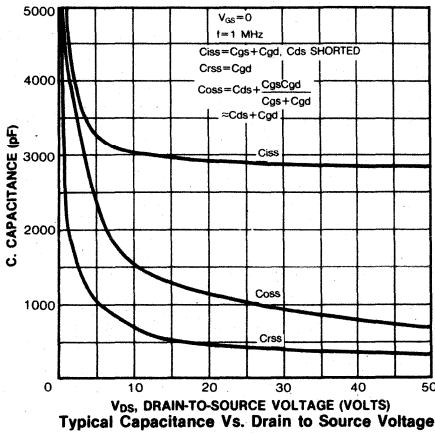

4

FEATURES

- Low $R_{DS(on)}$
- Improved inductive ruggedness
- Fast switching times
- Rugged polysilicon gate cell structure
- Low input capacitance
- Extended safe operating area
- Improved high temperature reliability
- TO-3P package

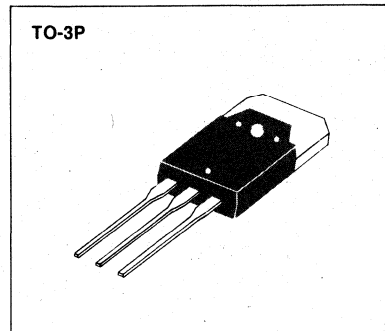

PRODUCT SUMMARY

Part Number	V_{DS}	$R_{DS(on)}$	I_D
IRFP220	200V	0.8 Ω	5.0A
IRFP221	150V	0.8 Ω	5.0A
IRFP222	200V	1.2 Ω	4.0A
IRFP223	150V	1.2 Ω	4.0A

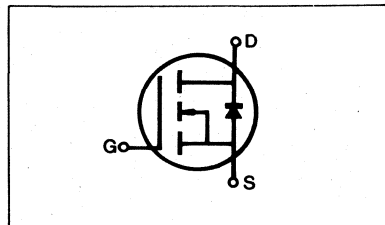

MAXIMUM RATINGS

Characteristic	Symbol	IRFP220	IRFP221	IRFP222	IRFP223	Unit
Drain-Source Voltage (1)	V_{DSS}	200	150	200	150	Vdc
Drain-Gate Voltage ($R_{GS}=1.0M\Omega$) (1)	V_{DGR}	200	150	200	150	Vdc
Gate-Source Voltage	V_{GS}	± 20				Vdc
Continuous Drain Current $T_C=25^\circ C$	I_D	5.0	5.0	4.0	4.0	Adc
Continuous Drain Current $T_C=100^\circ C$	I_D	3.0	3.0	2.0	2.0	Adc
Drain Current—Pulsed (3)	I_{DM}	20	20	16	16	Adc
Gate Current—Pulsed	I_{GM}	± 1.5				Adc
Total Power Dissipation @ $T_C=25^\circ C$ Derate above $25^\circ C$	P_D	40 0.32				Watts W/ $^\circ C$
Operating and Storage Junction Temperature Range	T_J, T_{stg}	-55 to 150				$^\circ C$
Maximum Lead Temp. for Soldering Purposes, 1/8" from case for 5 seconds	T_L	300				$^\circ C$

Notes: (1) $T_J=25^\circ C$ to $150^\circ C$

(2) Pulse test: Pulse width $\leq 300\mu s$, Duty Cycle $\leq 2\%$

(3) Repetitive rating: Pulse width limited by max. junction temperature

ELECTRICAL CHARACTERISTICS (T_C=25°C unless otherwise specified)

Characteristic	Symbol	Type	Min	Typ	Max	Units	Test Conditions
Drain-Source Breakdown Voltage	BV _{DSS}	IRFP220 IRFP222	200	—	—	V	V _{GS} =0V
		IRFP221 IRFP223	150	—	—	V	I _D =250μA
Gate Threshold Voltage	V _{GS(th)}	ALL	2.0	—	4.0	V	V _{DS} =V _{GS} , I _D =250μA
Gate-Source Leakage Forward	I _{GSS}	ALL	—	—	100	nA	V _{GS} =20V
Gate-Source Leakage Reverse	I _{GSS}	ALL	—	—	-100	nA	V _{GS} =-20V
Zero Gate Voltage Drain Current	I _{DSS}	ALL	—	—	250	μA	V _{DS} =Max. Rating, V _{GS} =0V
			—	—	1000	μA	V _{DS} =Max. Rating×0.8, V _{GS} =0V, T _C =125°C
On-State Drain-Source Current (2)	I _{D(on)}	IRFP220 IRFP221	5.0	—	—	A	V _{DS} >I _{D(on)} ×R _{DS(on)} max., V _{GS} =10V
		IRFP222 IRFP223	4.0	—	—	A	
Static Drain-Source On-State Resistance (2)	R _{DS(on)}	IRFP220 IRFP221	—	0.4	0.8	Ω	V _{GS} =10V, I _D =2.5A
		IRFP222 IRFP223	—	0.8	1.2	Ω	
Forward Transconductance (2)	g _{fs}	ALL	1.3	2.8	—	Ω	V _{DS} >I _{D(on)} ×R _{DS(on)} max., I _D =2.5A
Input Capacitance	C _{iss}	ALL	—	450	600	pF	V _{GS} =0V, V _{DS} =25V, f=1.0MHz
Output Capacitance	C _{oss}	ALL	—	150	300	pF	
Reverse Transfer Capacitance	C _{rss}	ALL	—	50	80	pF	V _{DD} =0.5BV _{DSS} , I _D =2.5A, Z _O =50 Ω (MOSFET switching times are essentially independent of operating temperature)
Turn-On Delay Time	t _{d(on)}	ALL	—	—	40	ns	
Rise Time	T _r	ALL	—	—	60	ns	
Turn-Off Delay Time	t _{d(off)}	ALL	—	—	100	ns	
Fall Time	t _f	ALL	—	—	60	ns	V _{GS} =10V, I _D =6.0A, V _{DS} =0.8 Max. Rating (Gate charge is essentially independent of operating temperature.)
Total Gate Charge (Gate-Source Plus Gate-Drain)	Q _g	ALL	—	12.5	15	nC	
Gate-Source Charge	Q _{gs}	ALL	—	4.0	—	nC	
Gate-Drain ("Miller") Charge	Q _{gd}	ALL	—	8.5	—	nC	

THERMAL RESISTANCE

Junction-to-Case	R _{thJC}	ALL	—	—	3.12	K/W	
Case-to-Sink	R _{thCS}	ALL	—	0.1	—	K/W	Mounting surface flat, smooth, and greased
Junction-to-Ambient	R _{thJA}	ALL	—	—	80	K/W	Free Air Operation

- Notes:** (1) T_J=25°C to 150°C
 (2) Pulse test: Pulse width≤300μs, Duty Cycle≤2%
 (3) Repetitive rating: Pulse width limited by max. junction temperature

SOURCE-DRAIN DIODE RATINGS AND CHARACTERISTICS

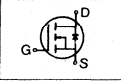
Characteristic	Symbol	Type	Min	Typ	Max	Units	Test Conditions
Continuous Source Current (Body Diode)	I_S	IRFP220	—	—	5.0	A	Modified MOSFET symbol showing the integral reverse P-N junction rectifier 
		IRFP221	—	—	4.0	A	
		IRFP222	—	—	4.0	A	
		IRFP223	—	—	4.0	A	
Pulse Source Current (Body Diode) (3)	I_{SM}	IRFP220	—	—	20	A	
		IRFP221	—	—	20	A	
		IRFP222 IRFP223	—	—	16	A	
Diode Forward Voltage (2)	V_{SD}	IRFP220 IRFP221	—	—	2.0	V	$T_C=25^\circ\text{C}$, $I_S=5.0\text{A}$, $V_{GS}=0\text{V}$
		IRFP222 IRFP223	—	—	1.8	V	$T_C=25^\circ\text{C}$, $I_S=4.0\text{A}$, $V_{GS}=0\text{V}$
Reverse Recovery Time	t_{rr}	ALL	—	350	—	ns	$T_J=150^\circ\text{C}$, $I_F=5.0\text{A}$, $di/dt=100\text{A}/\mu\text{s}$

Notes: (1) $T_J=25^\circ\text{C}$ to 150°C (2) Pulse test: Pulse width $\leq 300\mu\text{s}$, Duty Cycle $\leq 2\%$
 (3) Repetitive rating: Pulse width limited by max. junction temperature

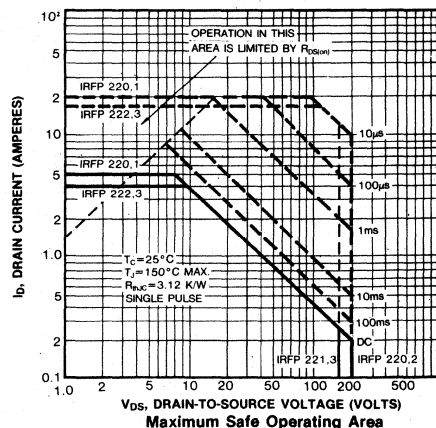
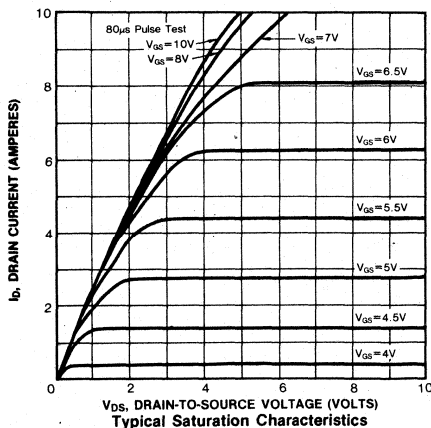
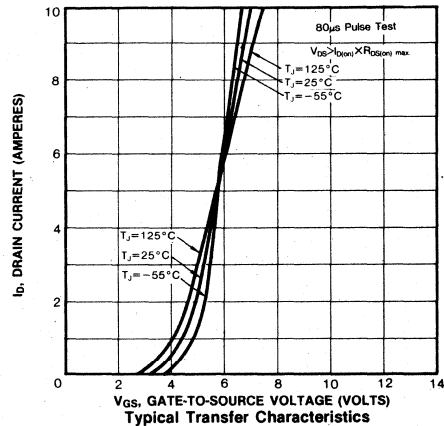
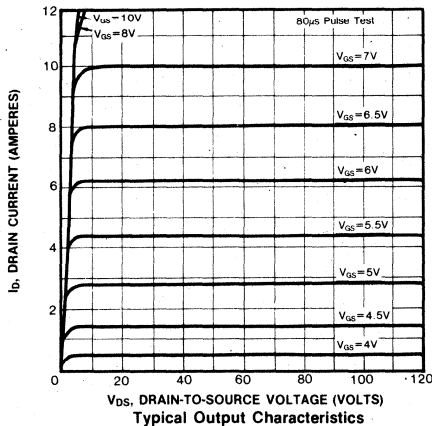

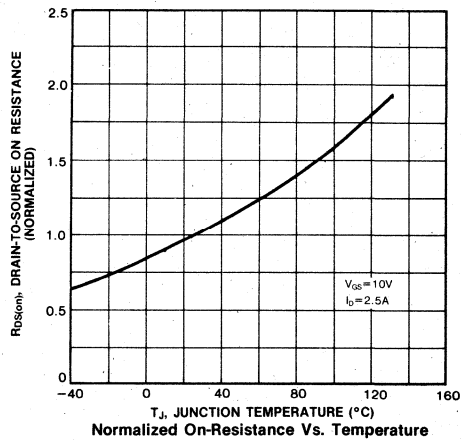
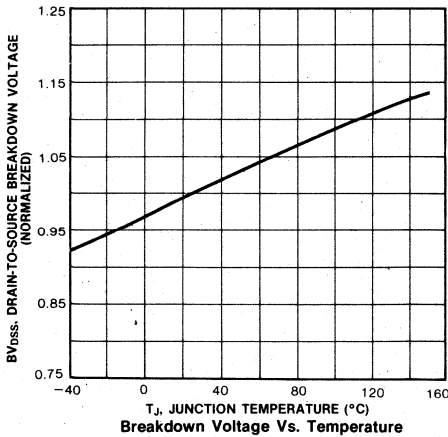
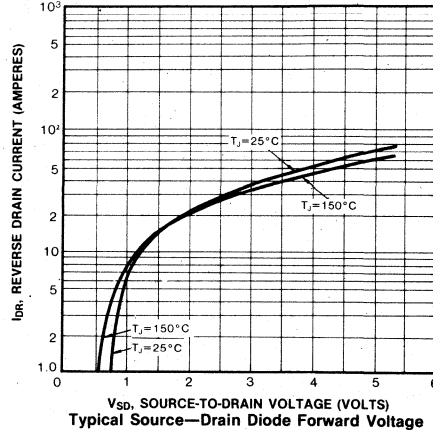
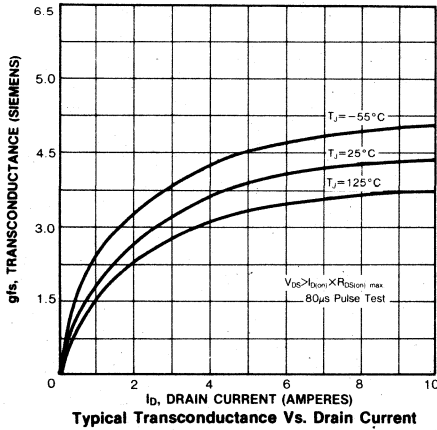
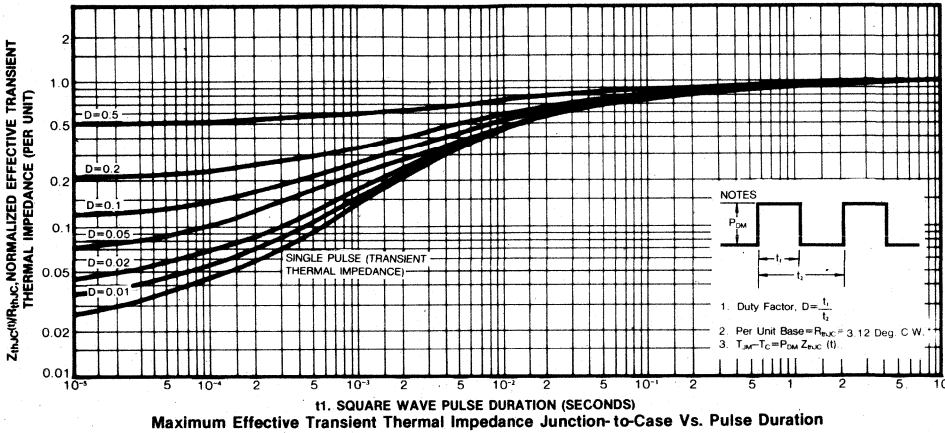

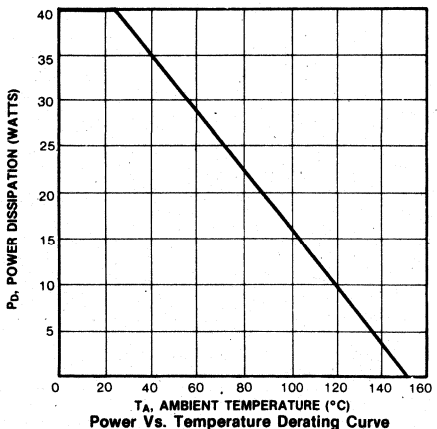
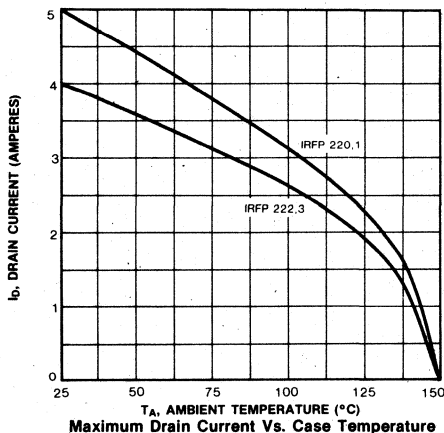
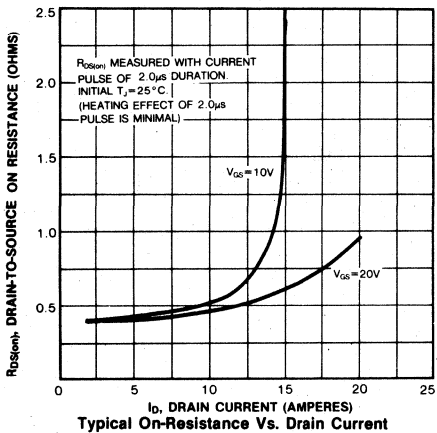
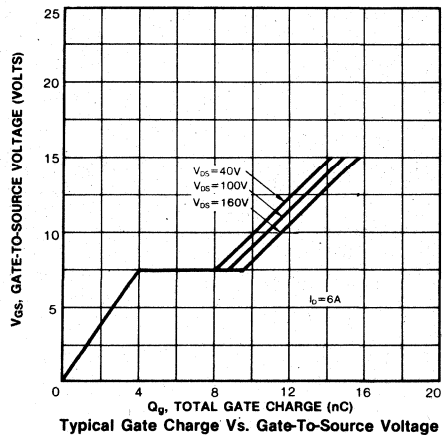
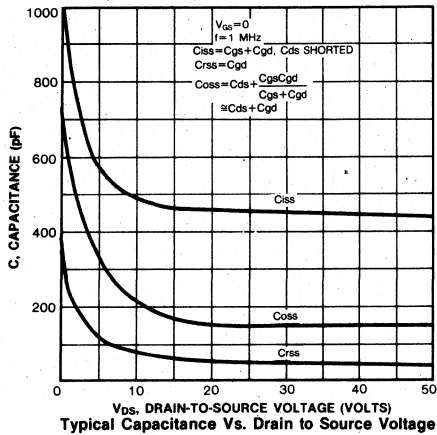

FEATURES

- Low $R_{DS(on)}$
- Improved inductive ruggedness
- Fast switching times
- Rugged polysilicon gate cell structure
- Low input capacitance
- Extended safe operating area
- Improved high temperature reliability
- TO-3P package

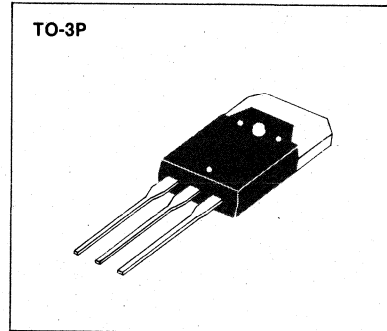

PRODUCT SUMMARY

Part Number	V_{DS}	$R_{DS(on)}$	I_D
IRFP230	200V	0.4 Ω	9.0A
IRFP231	150V	0.4 Ω	9.0A
IRFP232	200V	0.6 Ω	8.0A
IRFP233	150V	0.6 Ω	8.0A

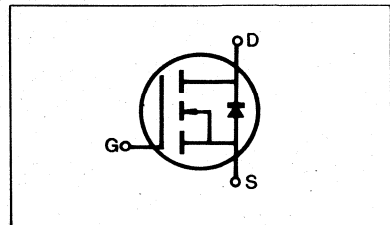

MAXIMUM RATINGS

Characteristic	Symbol	IRFP230	IRFP231	IRFP232	IRFP233	Unit
Drain-Source Voltage (1)	V_{DSS}	200	150	200	150	Vdc
Drain-Gate Voltage ($R_{GS}=1.0M\Omega$) (1)	V_{DGR}	200	150	200	150	Vdc
Gate-Source Voltage	V_{GS}	± 20				Vdc
Continuous Drain Current $T_C=25^\circ C$	I_D	9.0	9.0	8.0	8.0	Adc
Continuous Drain Current $T_C=100^\circ C$	I_D	6.0	6.0	5.0	5.0	Adc
Drain Current—Pulsed (3)	I_{DM}	36	36	32	32	Adc
Gate Current—Pulsed	I_{GM}	± 1.5				Adc
Total Power Dissipation @ $T_C=25^\circ C$ Derate above $25^\circ C$	P_D	75 0.6				Watts W/ $^\circ C$
Operating and Storage Junction Temperature Range	T_J, T_{stg}	-55 to 150				$^\circ C$
Maximum Lead Temp. for Soldering Purposes, 1/8" from case for 5 seconds	T_L	300				$^\circ C$

- Notes:** (1) $T_J=25^\circ C$ to $150^\circ C$
 (2) Pulse test: Pulse width $\leq 300\mu s$, Duty Cycle $\leq 2\%$
 (3) Repetitive rating: Pulse width limited by max. junction temperature

ELECTRICAL CHARACTERISTICS (T_C=25°C unless otherwise specified)

Characteristic	Symbol	Type	Min	Typ	Max	Units	Test Conditions
Drain-Source Breakdown Voltage	BV _{DSS}	IRFP230 IRFP232	200	—	—	V	V _{GS} =0V
		IRFP231 IRFP233	150	—	—	V	I _D =250μA
Gate Threshold Voltage	V _{GS(th)}	ALL	2.0	—	4.0	V	V _{DS} =V _{GS} , I _D =250μA
Gate-Source Leakage Forward	I _{GSS}	ALL	—	—	100	nA	V _{GS} =20V
Gate-Source Leakage Reverse	I _{GSS}	ALL	—	—	-100	nA	V _{GS} =-20V
Zero Gate Voltage Drain Current	I _{DSS}	ALL	—	—	250	μA	V _{DS} =Max. Rating, V _{GS} =0V
			—	—	1000	μA	V _{DS} =Max. Rating×0.8, V _{GS} =0V, T _C =125°C
On-State Drain-Source Current (2)	I _{D(on)}	IRFP230 IRFP231	9.0	—	—	A	V _{DS} >I _{D(on)} ×R _{DS(on) max.} , V _{GS} =10V
		IRFP232 IRFP233	8.0	—	—	A	
Static Drain-Source On-State Resistance (2)	R _{DS(on)}	IRFP230 IRFP231	—	0.25	0.4	Ω	V _{GS} =10V, I _D =5.0A
		IRFP232 IRFP233	—	0.4	0.6	Ω	
		—	—	—	—	—	
Forward Transconductance (2)	g _{fs}	ALL	3.0	4.6	—	Ω	V _{DS} >I _{D(on)} ×R _{DS(on) max.} , I _D =5.0A
Input Capacitance	C _{iSS}	ALL	—	720	800	pF	V _{GS} =0V, V _{DS} =25V, f=1.0MHz
Output Capacitance	C _{oss}	ALL	—	250	450	pF	
Reverse Transfer Capacitance	C _{rSS}	ALL	—	60	150	pF	
Turn-On Delay Time	t _{d(on)}	ALL	—	—	30	ns	V _{DD} =0.5BV _{DSS} , I _D =5.0A, Z _O =15 Ω (MOSFET switching times are essentially independent of operating temperature.)
Rise Time	t _r	ALL	—	—	50	ns	
Turn-Off Delay Time	t _{d(off)}	ALL	—	—	50	ns	
Fall Time	t _f	ALL	—	—	40	ns	
Total Gate Charge (Gate-Source Plus Gate-Drain)	Q _g	ALL	—	19	30	nC	V _{GS} =10V, I _D =12A, V _{DS} =0.8 Max. Rating (Gate charge is essentially independent of operating temperature.)
Gate-Source Charge	Q _{gs}	ALL	—	50	—	nC	
Gate-Drain ("Miller") Charge	Q _{gd}	ALL	—	14	—	nC	

THERMAL RESISTANCE

Junction-to-Case	R _{thJC}	ALL	—	—	1.67	K/W	
Case-to-Sink	R _{thCS}	ALL	—	0.1	—	K/W	Mounting surface flat, smooth, and greased
Junction-to-Ambient	R _{thJA}	ALL	—	—	80	K/W	Free Air Operation

- Notes:** (1) T_J=25°C to 150°C
 (2) Pulse test: Pulse width≤300μs, Duty Cycle≤2%
 (3) Repetitive rating: Pulse width limited by max. junction temperature

SOURCE-DRAIN DIODE RATINGS AND CHARACTERISTICS

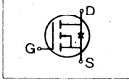
Characteristic	Symbol	Type	Min	Typ	Max	Units	Test Conditions
Continuous Source Current (Body Diode)	I _S	IRFP230	—	—	9.0	A	Modified MOSFET symbol showing the integral reverse P-N junction rectifier 
		IRFP231	—	—	9.0	A	
		IRFP232	—	—	8.0	A	
		IRFP233	—	—	8.0	A	
Pulse Source Current (Body Diode) (3)	I _{SM}	IRFP230	—	—	36	A	
		IRFP231	—	—	36	A	
		IRFP232	—	—	32	A	
		IRFP233	—	—	32	A	
Diode Forward Voltage (2)	V _{SD}	IRFP230	—	—	2.0	V	T _C =25°C, I _S =9.0A, V _{GS} =0V
		IRFP231	—	—	2.0	V	T _C =25°C, I _S =9.0A, V _{GS} =0V
		IRFP232	—	—	1.8	V	T _C =25°C, I _S =8.0A, V _{GS} =0V
		IRFP233	—	—	1.8	V	T _C =25°C, I _S =8.0A, V _{GS} =0V
Reverse Recovery Time	t _{rr}	ALL	—	450	—	ns	T _J =150°C, I _F =9.0A, dI _F /dt=100A/μs

Notes: (1) T_J=25°C to 150°C (2) Pulse test: Pulse width≤300μs, Duty Cycle≤2%
 (3) Repetitive rating: Pulse width limited by max. junction temperature

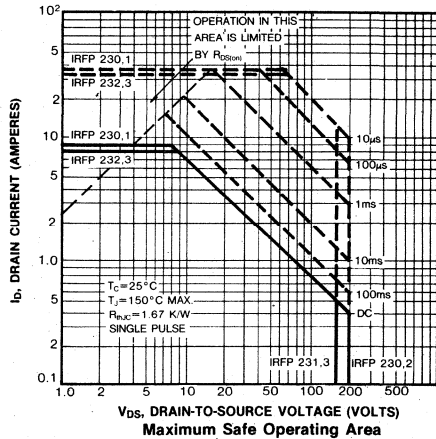
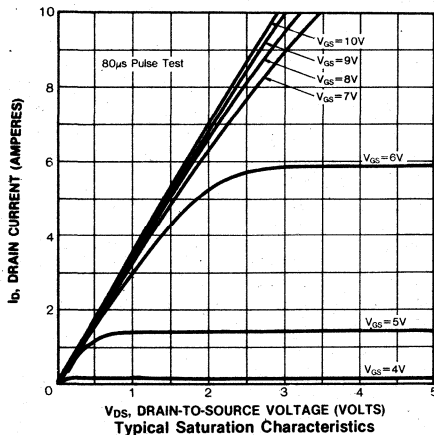
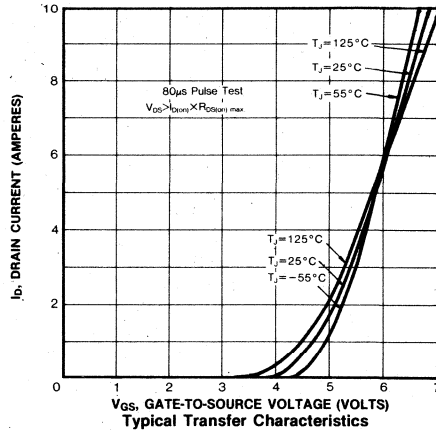
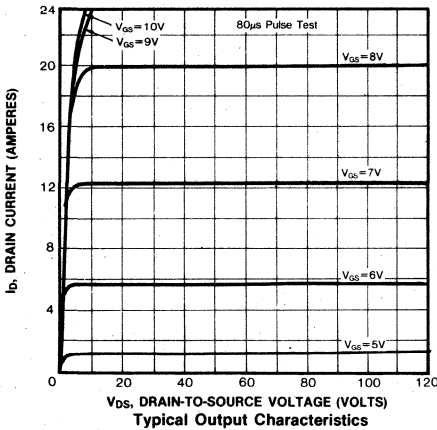

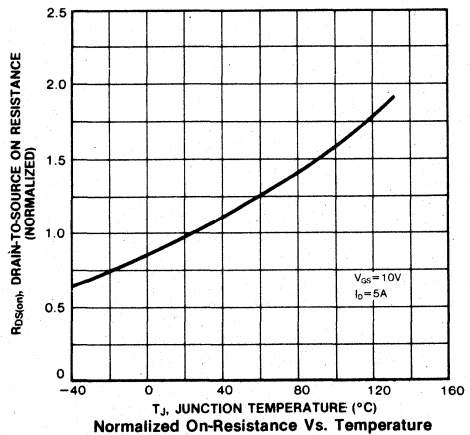
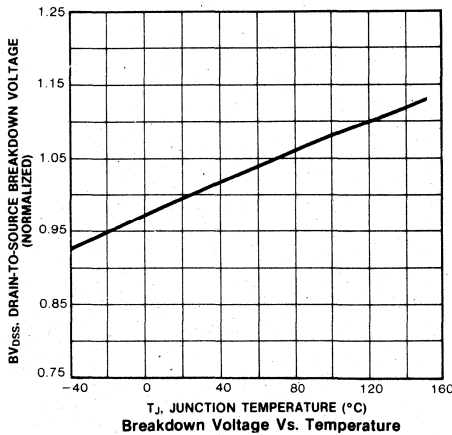
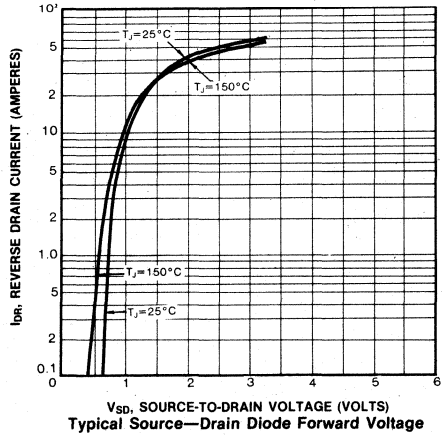
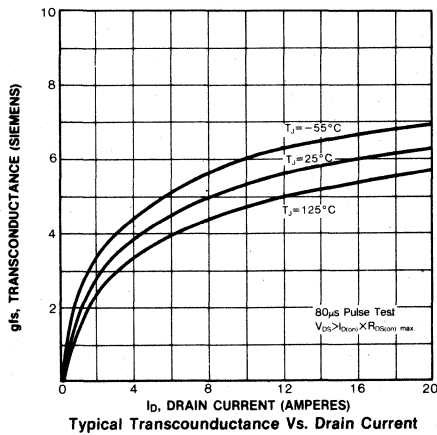
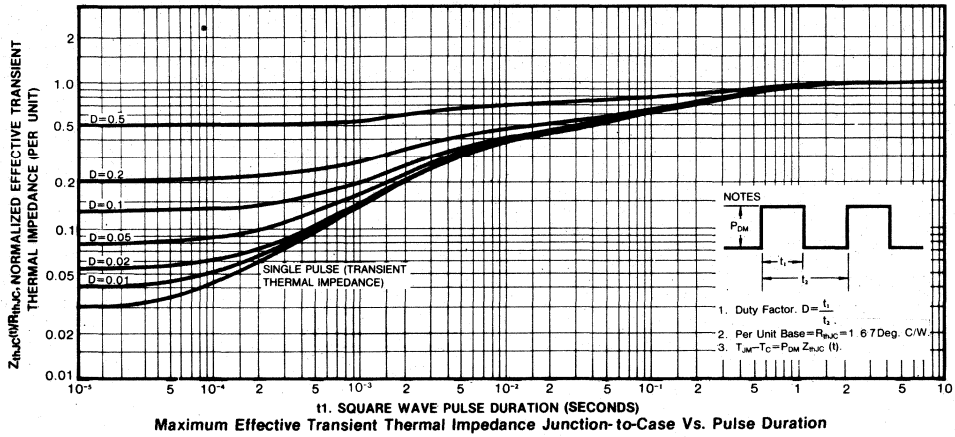

IRFP230/231/232/233

N-CHANNEL POWER MOSFETS

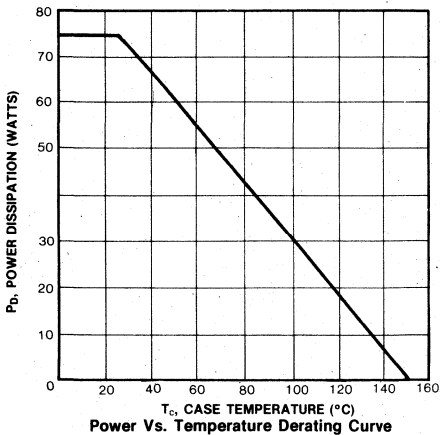
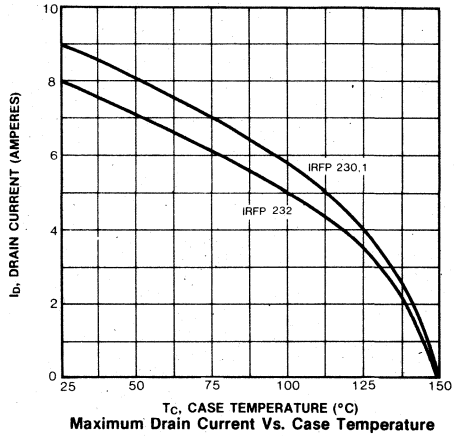
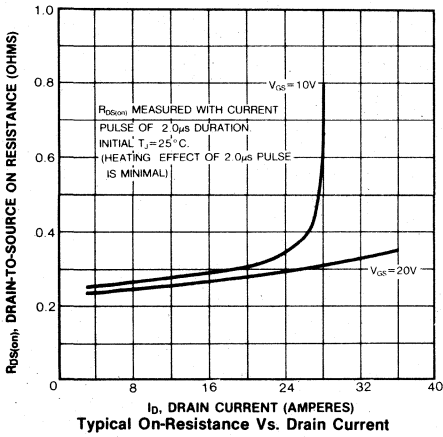
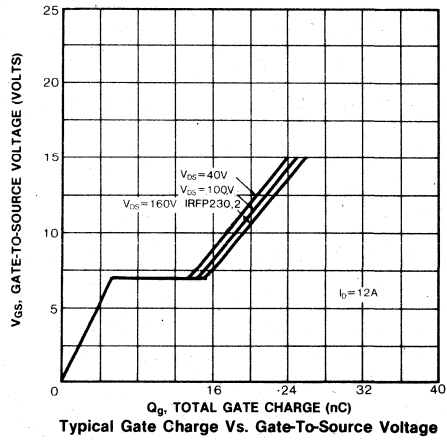
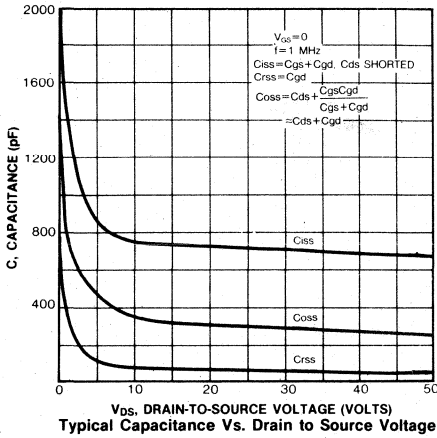

4

FEATURES

- Low $R_{DS(on)}$
- Improved inductive ruggedness
- Fast switching times
- Rugged polysilicon gate cell structure
- Low input capacitance
- Extended safe operating area
- Improved high temperature reliability
- TO-3P package

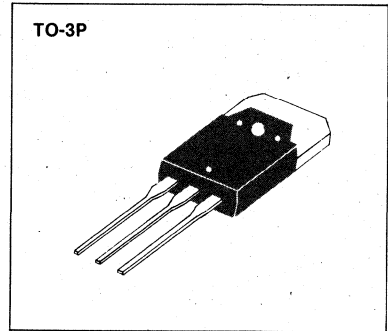

PRODUCT SUMMARY

Part Number	V_{DS}	$R_{DS(on)}$	I_D
IRFP240	200V	0.18 Ω	18A
IRFP241	150V	0.18 Ω	18A
IRFP242	200V	0.22 Ω	16A
IRFP243	150V	0.22 Ω	16A

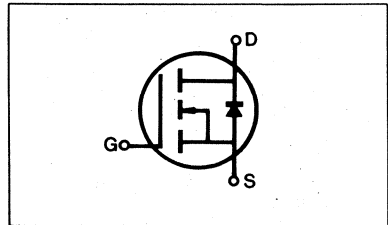

MAXIMUM RATINGS

Characteristic	Symbol	IRFP240	IRFP241	IRFP242	IRFP243	Unit
Drain-Source Voltage (1)	V_{DSS}	200	150	200	150	Vdc
Drain-Gate Voltage ($R_{GS}=1.0M\Omega$) (1)	V_{DGR}	200	150	200	150	Vdc
Gate-Source Voltage	V_{GS}	± 20				Vdc
Continuous Drain Current $T_C=25^\circ C$	I_D	18	18	16	16	Adc
Continuous Drain Current $T_C=100^\circ C$	I_D	11	11	10	10	Adc
Drain Current—Pulsed (3)	I_{DM}	72	72	64	64	Adc
Gate Current—Pulsed	I_{GM}	± 1.5				Adc
Total Power Dissipation @ $T_C=25^\circ C$ Derate above $25^\circ C$	P_D	125 1.0				Watts W/ $^\circ C$
Operating and Storage Junction Temperature Range	T_J, T_{stg}	-55 to 150				$^\circ C$
Maximum Lead Temp. for Soldering Purposes, 1/8" from case for 5 seconds	T_L	300				$^\circ C$

Notes: (1) $T_J=25^\circ C$ to $150^\circ C$

(2) Pulse test: Pulse width $< 300\mu s$, Duty Cycle $< 2\%$

(3) Repetitive rating: Pulse width limited by max. junction temperature

ELECTRICAL CHARACTERISTICS (T_C=25°C unless otherwise specified)

Characteristic	Symbol	Type	Min	Typ	Max	Units	Test Conditions
Drain-Source Breakdown Voltage	BV _{DSS}	IRFP240 IRFP242	200	—	—	V	V _{GS} =0V
		IRFP241 IRFP243	150	—	—	V	I _D =250μA
Gate Threshold Voltage	V _{GS(th)}	ALL	2.0	—	4.0	V	V _{DS} =V _{GS} , I _D =250μA
Gate-Source Leakage Forward	I _{GSS}	ALL	—	—	100	nA	V _{GS} =20V
Gate-Source Leakage Reverse	I _{GSS}	ALL	—	—	-100	nA	V _{GS} =-20V
Zero Gate Voltage Drain Current	I _{DSS}	ALL	—	—	250	μA	V _{DS} =Max. Rating, V _{GS} =0V
			—	—	1000	μA	V _{DS} =Max. Rating×0.8, V _{GS} =0V, T _C =125°C
On-State Drain-Source Current (2)	I _{D(on)}	IRFP240 IRFP241	18	—	—	A	V _{DS} >I _{D(on)} ×R _{DS(on)} max., V _{GS} =10V
		IRFP242 IRFP243	16	—	—	A	
Static Drain-Source On-State Resistance (2)	R _{DS(on)}	IRFP240 IRFP241	—	0.13	0.18	Ω	V _{GS} =10V, I _D =10A
		IRFP242 IRFP243	—	0.20	0.22	Ω	
Forward Transconductance (2)	g _{fs}	ALL	6.0	9.5	—	♢	V _{DS} >I _{D(on)} ×R _{DS(on)} max., I _D =10A
Input Capacitance	C _{iss}	ALL	—	1200	1600	pF	V _{GS} =0V, V _{DS} =25V, f=1.0MHz
Output Capacitance	C _{oss}	ALL	—	360	750	pF	
Reverse Transfer Capacitance	C _{rss}	ALL	—	130	300	pF	
Turn-On Delay Time	t _{d(on)}	ALL	—	—	30	ns	V _{DD} =0.5BV _{DSS} , I _D =10A, Z _O =4.7Ω (MOSFET switching times are essentially independent of operating temperature.)
Rise Time	T _r	ALL	—	—	60	ns	
Turn-Off Delay Time	t _{d(off)}	ALL	—	—	80	ns	
Fall Time	t _f	ALL	—	—	60	ns	V _{GS} =10V, I _D =22A, V _{DS} =0.8 Max. Rating (Gate charge is essentially independent of operating temperature.)
Total Gate Charge (Gate-Source Plus Gate-Drain)	Q _g	ALL	—	44	60	nC	
Gate-Source Charge	Q _{gs}	ALL	—	9	—	nC	
Gate-Drain ("Miller") Charge	Q _{gd}	ALL	—	35	—	nC	

THERMAL RESISTANCE

Junction-to-Case	R _{thJC}	ALL	—	—	1.0	K/W	
Case-to-Sink	R _{thCS}	ALL	—	0.1	—	K/W	Mounting surface flat, smooth, and greased
Junction-to-Ambient	R _{thJA}	ALL	—	—	80	K/W	Free Air Operation

- Notes:** (1) T_J=25°C to 150°C
 (2) Pulse test: Pulse width≤300μs, Duty Cycle≤2%
 (3) Repetitive rating: Pulse width limited by max. junction temperature

SOURCE-DRAIN DIODE RATINGS AND CHARACTERISTICS

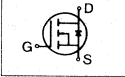
Characteristic	Symbol	Type	Min	Typ	Max	Units	Test Conditions
Continuous Source Current (Body Diode)	I_S	IRFP240	—	—	18	A	Modified MOSFET symbol showing the integral reverse P-N junction rectifier 
		IRFP241	—	—	16	A	
		IRFP242	—	—	16	A	
		IRFP243	—	—	16	A	
Pulse Source Current (Body Diode) (3)	I_{SM}	IRFP240	—	—	72	A	
		IRFP241	—	—	64	A	
		IRFP242	—	—	64	A	
		IRFP243	—	—	64	A	
Diode Forward Voltage (2)	V_{SD}	IRFP240	—	—	2.0	V	$T_C=25^\circ\text{C}$, $I_S=18\text{A}$, $V_{GS}=0\text{V}$
		IRFP241	—	—	1.9	V	$T_C=25^\circ\text{C}$, $I_S=16\text{A}$, $V_{GS}=0\text{V}$
Reverse Recovery Time	t_{rr}	ALL	—	650	—	ns	$T_J=150^\circ\text{C}$, $I_F=18\text{A}$, $di/dt=100\text{A}/\mu\text{s}$

Notes: (1) $T_J=25^\circ\text{C}$ to 150°C (2) Pulse test: Pulse width $\leq 300\mu\text{s}$, Duty Cycle $\leq 2\%$
 (3) Repetitive rating: Pulse width limited by max. junction temperature

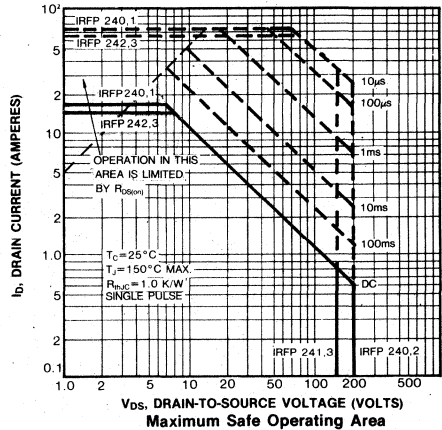
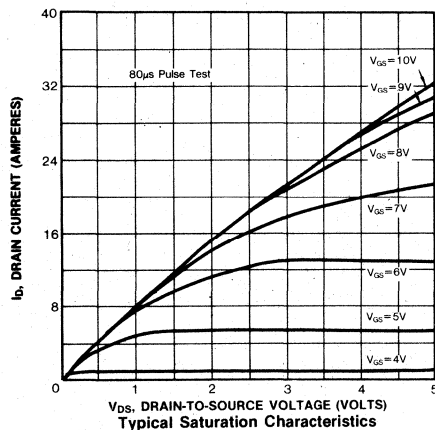
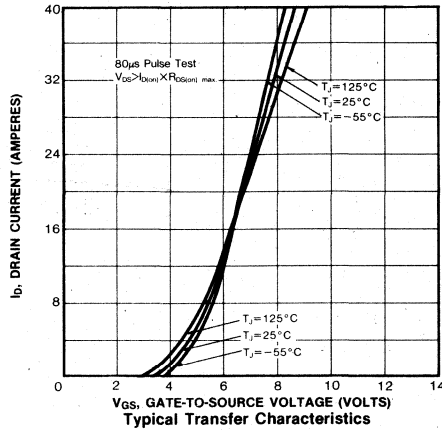
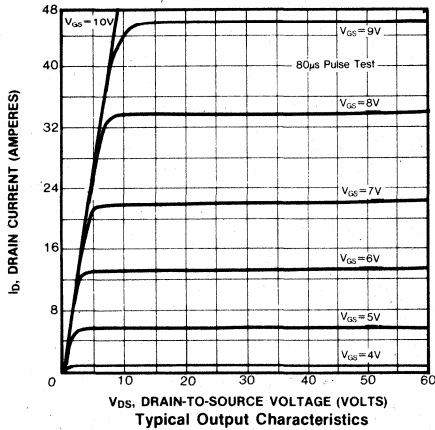

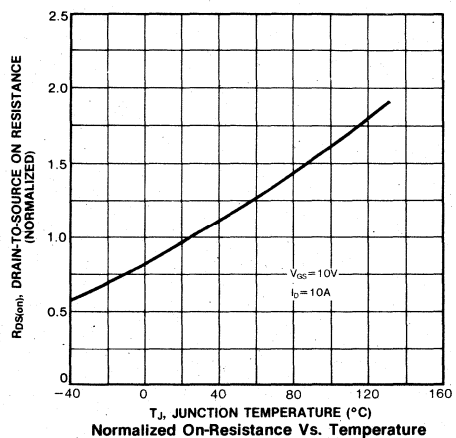
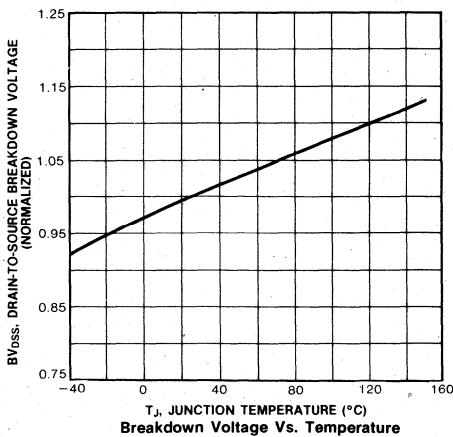
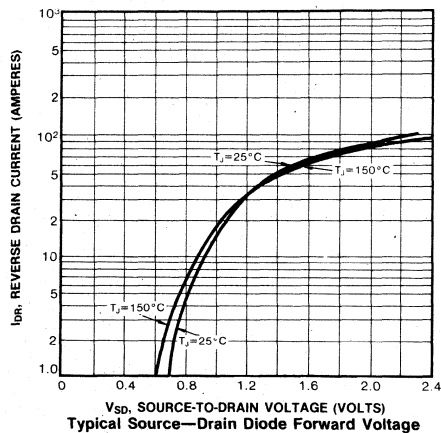
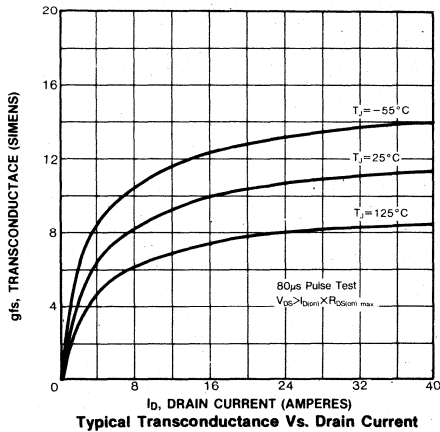
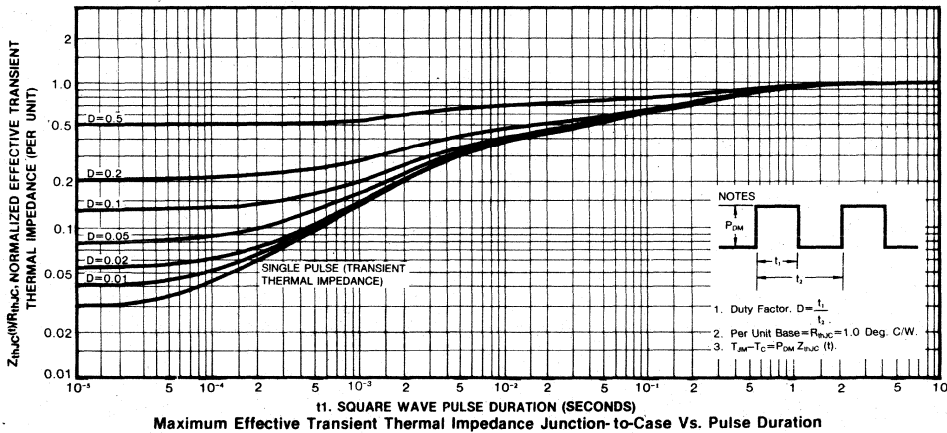

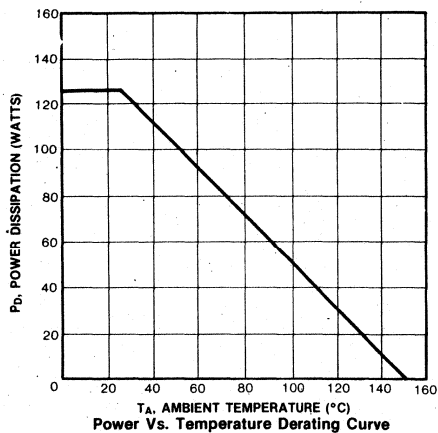
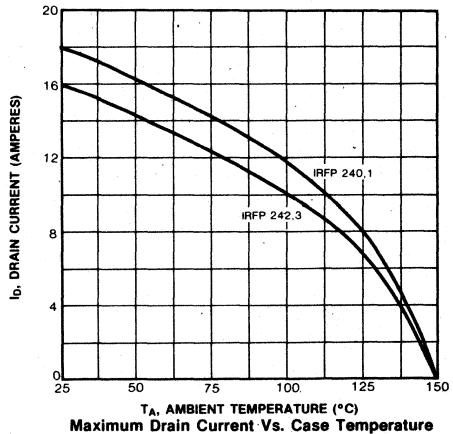
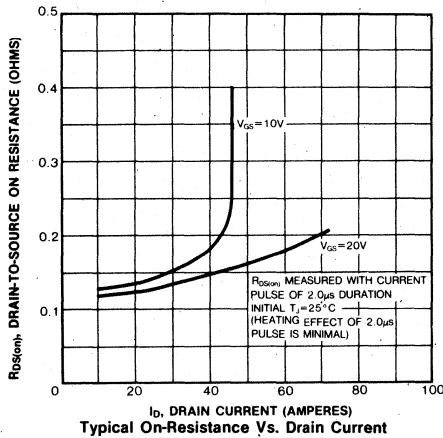
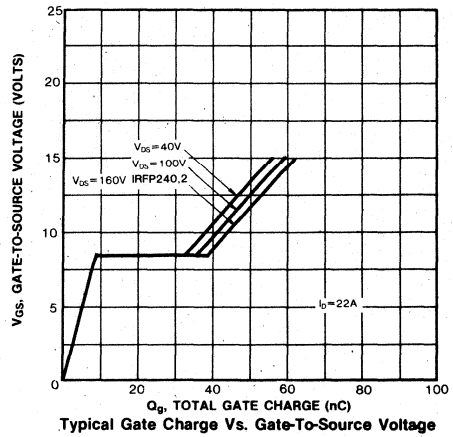
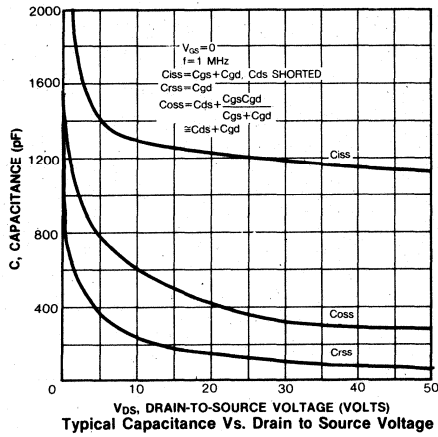

FEATURES

- Low $R_{DS(on)}$
- Improved inductive ruggedness
- Fast switching times
- Rugged polysilicon gate cell structure
- Low input capacitance
- Extended safe operating area
- Improved high temperature reliability
- TO-3P package

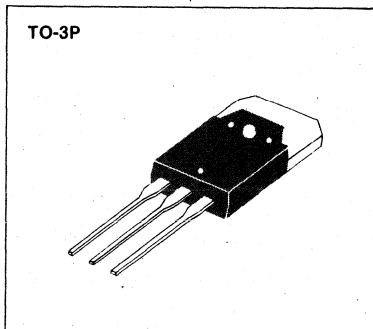

PRODUCT SUMMARY

Part Number	V_{DS}	$R_{DS(on)}$	I_D
IRFP250	200V	0.085 Ω	30A
IRFP251	150V	0.085 Ω	30A
IRFP252	200V	0.12 Ω	25A
IRFP253	150V	0.12 Ω	25A

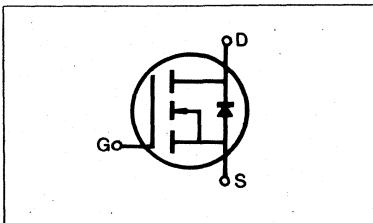

MAXIMUM RATINGS

Characteristic	Symbol	IRFP250	IRFP251	IRFP252	IRFP253	Unit
Drain-Source Voltage (1)	V_{DSS}	200	150	200	150	Vdc
Drain-Gate Voltage ($R_{GS}=1.0M\Omega$) (1)	V_{DGR}	200	150	200	150	Vdc
Gate-Source Voltage	V_{GS}	±20				Vdc
Continuous Drain Current $T_C=25^\circ C$	I_D	30	30	25	25	Adc
Continuous Drain Current $T_C=100^\circ C$	I_D	19	19	16	16	Adc
Drain Current—Pulsed (3)	I_{DM}	120	120	100	100	Adc
Gate Current—Pulsed	I_{GM}	±1.5				Adc
Total Power Dissipation @ $T_C=25^\circ C$ Derate above $25^\circ C$	P_D	150 1.2				Watts W/ $^\circ C$
Operating and Storage Junction Temperature Range	T_J, T_{stg}	-55 to 150				$^\circ C$
Maximum Lead Temp. for Soldering Purposes, 1/8" from case for 5 seconds	T_L	300				$^\circ C$

Notes: (1) $T_J=25^\circ C$ to $150^\circ C$

(2) Pulse test: Pulse width $\leq 300\mu s$, Duty Cycle $\leq 2\%$

(3) Repetitive rating: Pulse width limited by max. junction temperature

ELECTRICAL CHARACTERISTICS (T_C=25°C unless otherwise specified)

Characteristic	Symbol	Type	Min	Typ	Max	Units	Test Conditions
Drain-Source Breakdown Voltage	BV _{DSS}	IRFP250 IRFP252	200	—	—	V	V _{GS} =0V
		IRFP251 IRFP253	150	—	—	V	I _D =250μA
Gate Threshold Voltage	V _{GS(th)}	ALL	2.0	—	4.0	V	V _{DS} =V _{GS} , I _D =250μA
Gate-Source Leakage Forward	I _{GSS}	ALL	—	—	100	nA	V _{GS} =20V
Gate-Source Leakage Reverse	I _{GSS}	ALL	—	—	-100	nA	V _{GS} =-20V
Zero Gate Voltage Drain Current	I _{DSS}	ALL	—	—	250	μA	V _{DS} =Max. Rating, V _{GS} =0V
			—	—	1000	μA	V _{DS} =Max. Rating×0.8, V _{GS} =0V, T _C =125°C
On-State Drain-Source Current (2)	I _{D(on)}	IRFP250 IRFP251	30	—	—	A	V _{DS} >I _{D(on)} ×R _{DS(on)} max., V _{GS} =10V
		IRFP252 IRFP253	25	—	—	A	
Static Drain-Source On-State Resistance (2)	R _{DS(on)}	IRFP250 IRFP251	—	0.07	0.085	Ω	V _{GS} =10V, I _D =16A
		IRFP252 IRFP253	—	0.09	0.120	Ω	
Forward Transconductance (2)	g _{fs}	ALL	8.0	12.5	—	Ω	V _{DS} >I _{D(on)} ×R _{DS(on)} max., I _D =16A
Input Capacitance	C _{iss}	ALL	—	2640	3000	pF	V _{GS} =0V, V _{DS} =25V, f=1.0MHz
Output Capacitance	C _{oss}	ALL	—	800	1200	pF	
Reverse Transfer Capacitance	C _{rss}	ALL	—	300	500	pF	
Turn-On Delay Time	t _{d(on)}	ALL	—	—	35	ns	V _{DD} =0.5BV _{DSS} , I _D =2.5A, Z _O =15 Ω (MOSFET switching times are essentially independent of operating temperature)
Rise Time	t _r	ALL	—	—	100	ns	
Turn-Off Delay Time	t _{d(off)}	ALL	—	—	125	ns	
Fall Time	t _f	ALL	—	—	100	ns	
Total Gate Charge (Gate-Source Plus Gate-Drain)	Q _g	ALL	—	68	120	nC	V _{GS} =10V, I _D =38A, V _{DS} =0.8 Max. Rating (Gate charge is essentially independent of operating temperature.)
Gate-Source Charge	Q _{gs}	ALL	—	18	—	nC	
Gate-Drain ("Miller") Charge	Q _{gd}	ALL	—	50	—	nC	

THERMAL RESISTANCE

Junction-to-Case	R _{thJC}	ALL	—	—	0.83	K/W	
Case-to-Sink	R _{thCS}	ALL	—	0.1	—	K/W	Mounting surface flat, smooth, and greased
Junction-to-Ambient	R _{thJA}	ALL	—	—	80	K/W	Free Air Operation

- Notes:** (1) T_J=25°C to 150°C
 (2) Pulse test: Pulse width≤300μs, Duty Cycle≤2%
 (3) Repetitive rating: Pulse width limited by max. junction temperature

SOURCE-DRAIN DIODE RATINGS AND CHARACTERISTICS

Characteristic	Symbol	Type	Min	Typ	Max	Units	Test Conditions
Continuous Source Current (Body Diode)	I _S	IRFP250	—	—	30	A	Modified MOSFET symbol showing the integral reverse P-N junction rectifier
		IRFP251	—	—	30	A	
		IRFP252	—	—	25	A	
		IRFP253	—	—	25	A	
Pulse Source Current (Body Diode) (3)	I _{SM}	IRFP250	—	—	120	A	
		IRFP251	—	—	120	A	
		IRFP252	—	—	100	A	
		IRFP253	—	—	100	A	
Diode Forward Voltage (2)	V _{SD}	IRFP250	—	—	2.0	V	T _C =25°C, I _S =30A, V _{GS} =0V
		IRFP251	—	—	2.0	V	T _C =25°C, I _S =30A, V _{GS} =0V
		IRFP252	—	—	1.8	V	T _C =25°C, I _S =25A, V _{GS} =0V
		IRFP253	—	—	1.8	V	T _C =25°C, I _S =25A, V _{GS} =0V
Reverse Recovery Time	t _{rr}	ALL	—	750	—	ns	T _J =150°C, I _F =30A, dI _F /dt=100A/μs

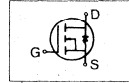

Notes: (1) T_J=25°C to 150°C (2) Pulse test: Pulse width ≤ 300μs, Duty Cycle ≤ 2%
 (3) Repetitive rating: Pulse width limited by max. junction temperature

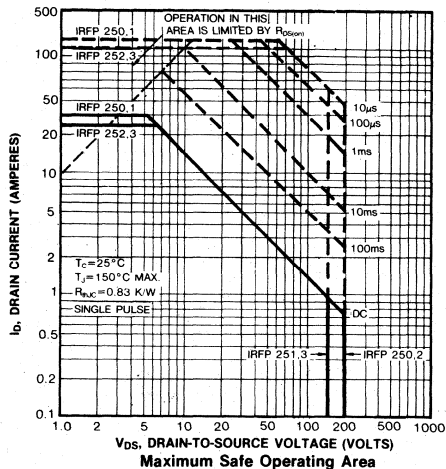
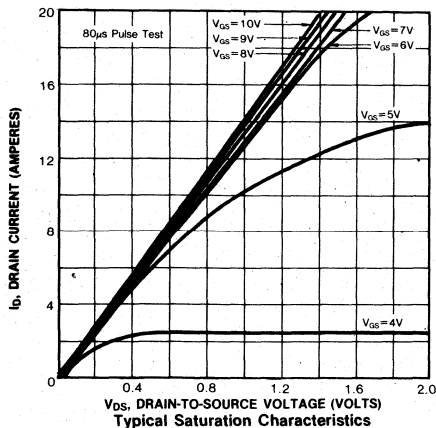
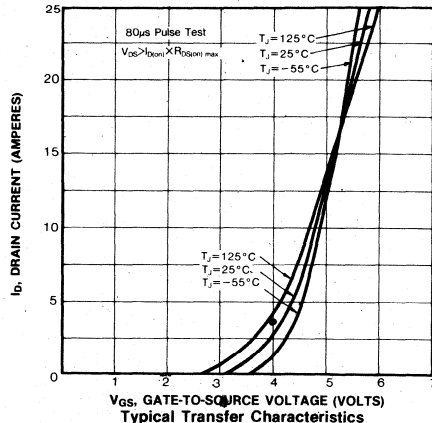
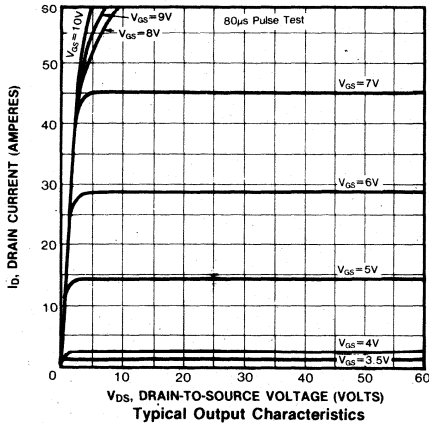

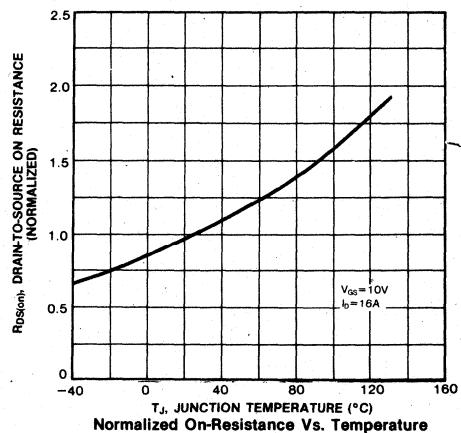
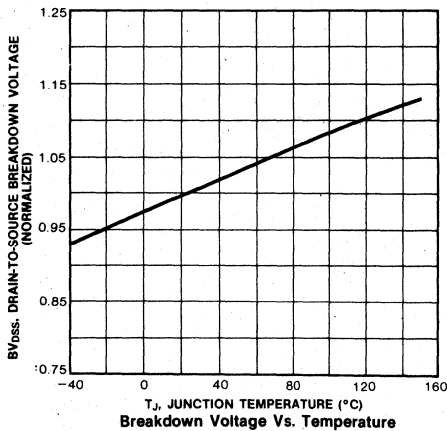
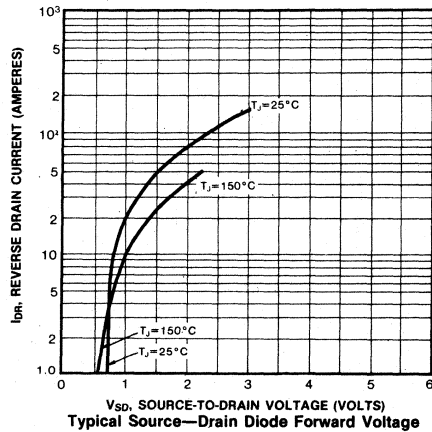
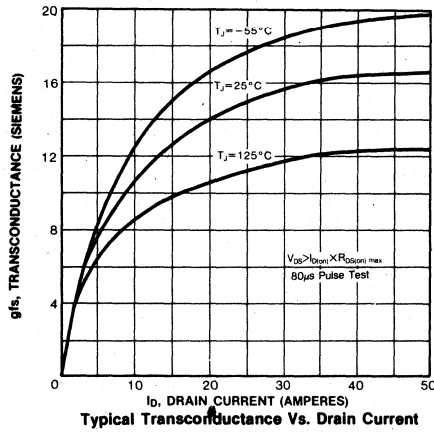
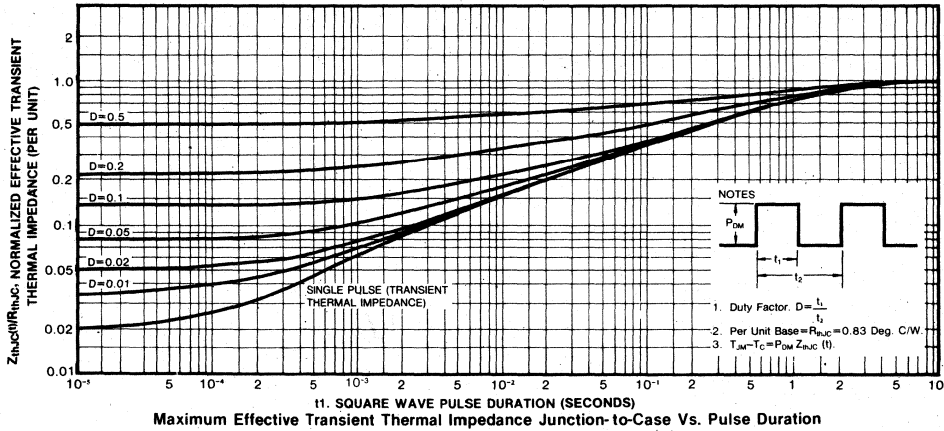

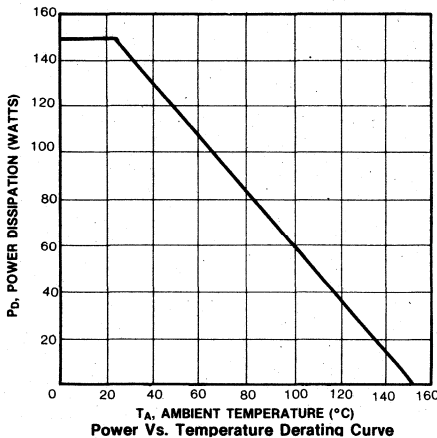
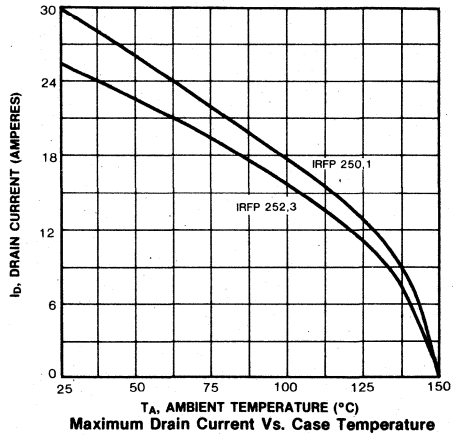
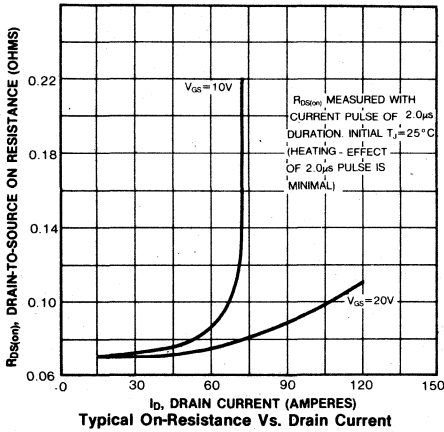
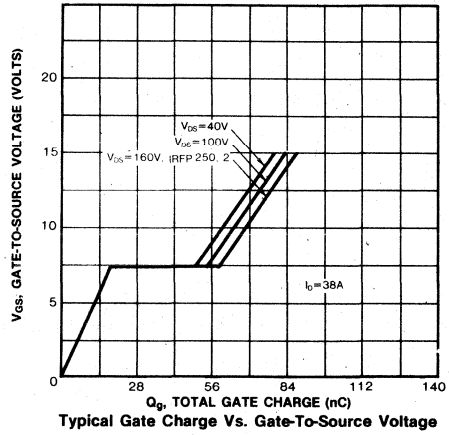
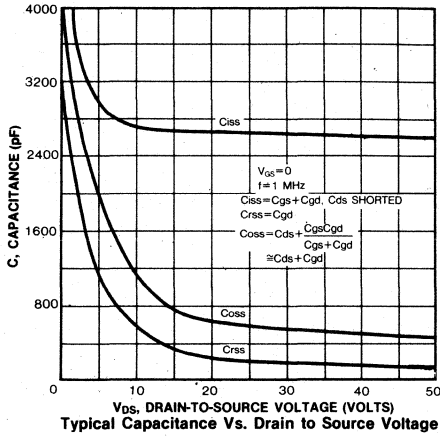

4

FEATURES

- Low $R_{DS(on)}$
- Improved inductive ruggedness
- Fast switching times
- Rugged polysilicon gate cell structure
- Low input capacitance
- Extended safe operating area
- Improved high temperature reliability
- TO-3P package

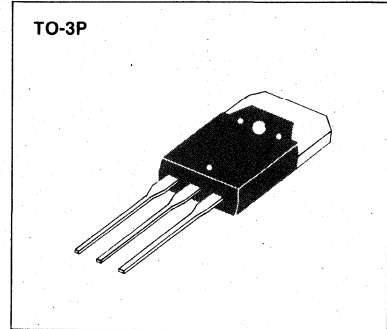

PRODUCT SUMMARY

Part Number	V_{DS}	$R_{DS(on)}$	I_D
IRFP320	400V	1.8 Ω	3.0A
IRFP321	350V	1.8 Ω	3.0A
IRFP322	400V	2.5 Ω	2.5A
IRFP323	350V	2.5 Ω	2.5A

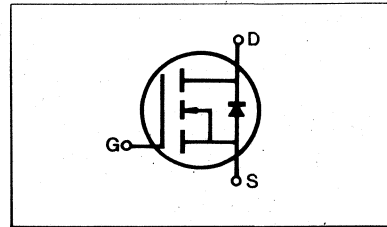

MAXIMUM RATINGS

Characteristic	Symbol	IRFP320	IRFP321	IRFP322	IRFP323	Unit
Drain-Source Voltage (1)	V_{DSS}	400	350	400	350	Vdc
Drain-Gate Voltage ($R_{GS}=1.0M\Omega$) (1)	V_{DGR}	400	350	400	350	Vdc
Gate-Source Voltage	V_{GS}	± 20				Vdc
Continuous Drain Current $T_C=25^\circ C$	I_D	3.0	3.0	2.5	2.5	Adc
Continuous Drain Current $T_C=100^\circ C$	I_D	2.0	2.0	1.5	1.5	Adc
Drain Current—Pulsed (3)	I_{DM}	12	12	10	10	Adc
Gate Current—Pulsed	I_{GM}	± 1.5				Adc
Total Power Dissipation @ $T_C=25^\circ C$ Derate above $25^\circ C$	P_D	40 0.32				Watts W/ $^\circ C$
Operating and Storage Junction Temperature Range	T_J, T_{stg}	-55 to 150				$^\circ C$
Maximum Lead Temp. for Soldering Purposes, 1/8" from case for 5 seconds	T_L	300				$^\circ C$

- Notes: (1) $T_J=25^\circ C$ to $150^\circ C$
 (2) Pulse test: Pulse width $\leq 300\mu s$, Duty Cycle $\leq 2\%$
 (3) Repetitive rating: Pulse width limited by max. junction temperature

ELECTRICAL CHARACTERISTICS (T_C=25°C unless otherwise specified)

Characteristic	Symbol	Type	Min	Typ	Max	Units	Test Conditions
Drain-Source Breakdown Voltage	BV _{DSS}	IRFP320 IRFP322	400	—	—	V	V _{GS} =0V
		IRFP321 IRFP323	350	—	—	V	I _D =250μA
Gate Threshold Voltage	V _{GS(th)}	ALL	2.0	—	4.0	V	V _{DS} =V _{GS} , I _D =250μA
Gate-Source Leakage Forward	I _{GSS}	ALL	—	—	100	nA	V _{GS} =20V
Gate-Source Leakage Reverse	I _{GSS}	ALL	—	—	-100	nA	V _{GS} =-20V
Zero Gate Voltage Drain Current	I _{DSS}	ALL	—	—	250	μA	V _{DS} =Max. Rating, V _{GS} =0V
			—	—	1000	μA	V _{DS} =Max. Rating×0.8, V _{GS} =0V, T _C =125°C
On-State Drain-Source Current (2)	I _{D(on)}	IRFP320 IRFP321	3.0	—	—	A	V _{DS} >I _{D(on)} ×R _{DS(on) max.} , V _{GS} =10V
		IRFP322 IRFP323	2.5	—	—	A	
Static Drain-Source On-State Resistance (2)	R _{DS(on)}	IRFP320 IRFP321	—	1.4	1.8	Ω	V _{GS} =10V, I _D =1.5A
		IRFP322 IRFP323	—	1.7	2.5	Ω	
Forward Transconductance (2)	g _{fs}	ALL	1.0	2.2	—	∅	V _{DS} >I _{D(on)} ×R _{DS(on) max.} , I _D =1.5A
Input Capacitance	C _{iss}	ALL	—	400	600	pF	V _{GS} =0V, V _{DS} =25V, f=1.0MHz
Output Capacitance	C _{oss}	ALL	—	90	200	pF	
Reverse Transfer Capacitance	C _{rss}	ALL	—	30	40	pF	
Turn-On Delay Time	t _{d(on)}	ALL	—	—	40	ns	V _{DD} =0.5BV _{DSS} , I _D =1.5A, Z _O =50Ω, (MOSFET switching times are essentially independent of operating temperature.)
Rise Time	t _r	ALL	—	—	50	ns	
Turn-Off Delay Time	t _{d(off)}	ALL	—	—	100	ns	
Fall Time	t _f	ALL	—	—	50	ns	
Total Gate Charge (Gate-Source Plus Gate-Drain)	Q _g	ALL	—	12.5	15	nC	V _{GS} =10V, I _D =4.0A, V _{DS} =0.8 Max. Rating (Gate charge is essentially independent of operating temperature.)
Gate-Source Charge	Q _{gs}	ALL	—	2.8	—	nC	
Gate-Drain ("Miller") Charge	Q _{gd}	ALL	—	9.7	—	nC	

THERMAL RESISTANCE

Junction-to-Case	R _{thJC}	ALL	—	—	3.12	K/W	
Case-to-Sink	R _{thCS}	ALL	—	0.1	—	K/W	Mounting surface flat, smooth, and greased
Junction-to-Ambient	R _{thJA}	ALL	—	—	30	K/W	Free Air Operation

- Notes:** (1) T_J=25°C to 150°C
 (2) Pulse test: Pulse width≤300μs, Duty Cycle≤2%
 (3) Repetitive rating: Pulse width limited by max. junction temperature

SOURCE-DRAIN DIODE RATINGS AND CHARACTERISTICS

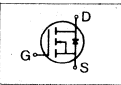
Characteristic	Symbol	Type	Min	Typ	Max	Units	Test Conditions
Continuous Source Current (Body Diode)	I_S	IRFP320	—	—	3.0	A	Modified MOSFET symbol showing the integral reverse P-N junction rectifier 
		IRFP321	—	—	3.0	A	
		IRFP322	—	—	2.5	A	
		IRFP323	—	—	2.5	A	
Pulse Source Current (Body Diode) (3)	I_{SM}	IRFP320	—	—	12	A	
		IRFP321	—	—	12	A	
		IRFP322	—	—	10	A	
		IRFP323	—	—	10	A	
Diode Forward Voltage (2)	V_{SD}	IRFP320	—	—	1.6	V	$T_C=25^\circ\text{C}$, $I_S=3.0\text{A}$, $V_{GS}=0\text{V}$
		IRFP321	—	—	1.6	V	$T_C=25^\circ\text{C}$, $I_S=3.0\text{A}$, $V_{GS}=0\text{V}$
		IRFP322	—	—	1.5	V	$T_C=25^\circ\text{C}$, $I_S=2.5\text{A}$, $V_{GS}=0\text{V}$
Reverse Recovery Time	t_{rr}	ALL	—	450	—	ns	$T_J=150^\circ\text{C}$, $I_F=3.0\text{A}$, $dI_F/dt=100\text{A}/\mu\text{s}$

Notes: (1) $T_J=25^\circ\text{C}$ to 150°C (2) Pulse test: Pulse width $<300\mu\text{s}$, Duty Cycle $<2\%$
 (3) Repetitive rating: Pulse width limited by max. junction temperature

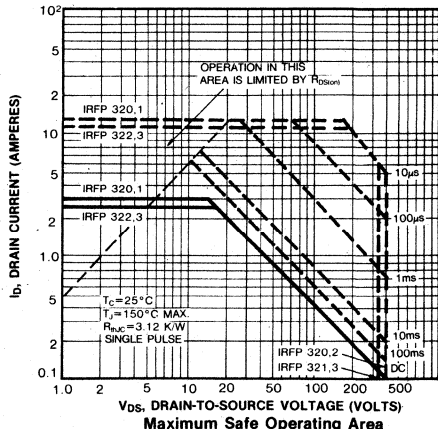
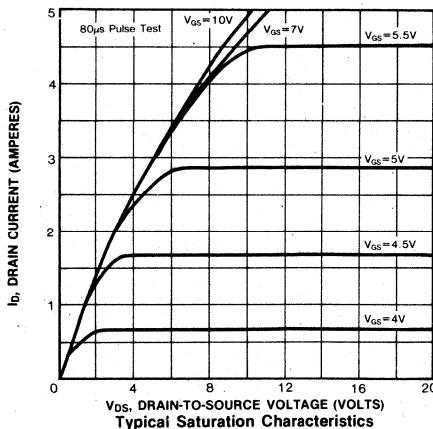
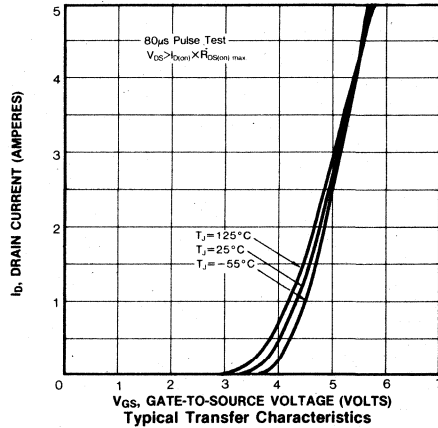
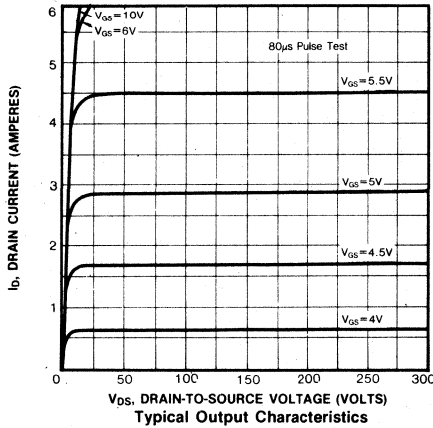

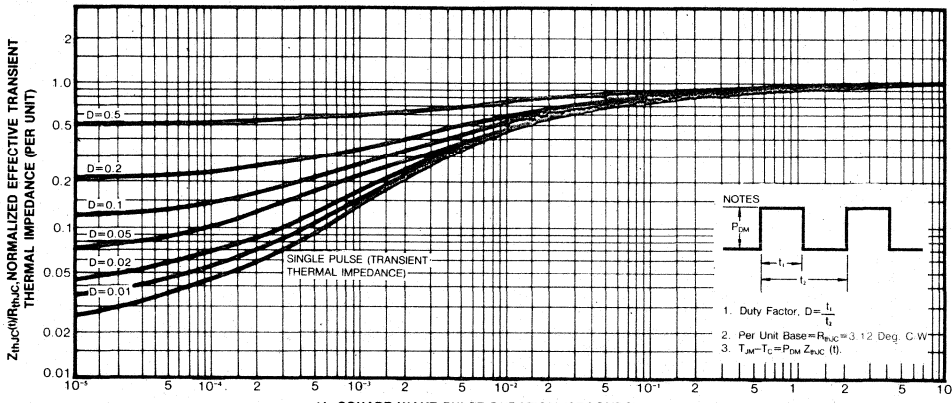

11. SQUARE WAVE PULSE DURATION (SECONDS)
Maximum Effective Transient Thermal Impedance Junction-to-Case Vs. Pulse Duration

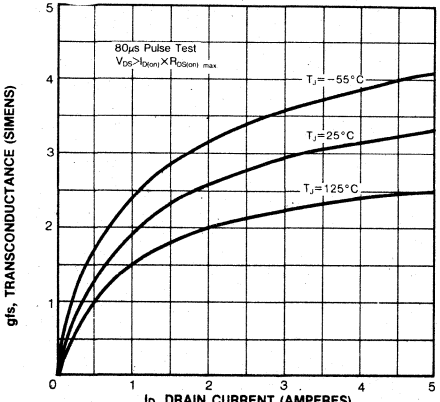

Typical Transconductance Vs. Drain Current

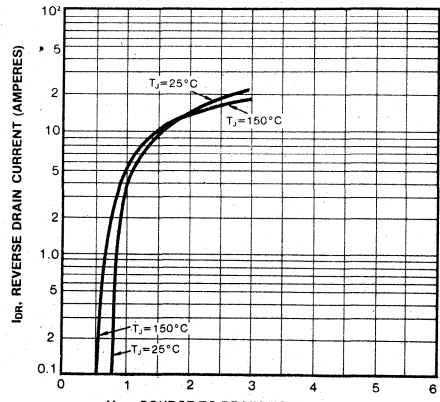

Typical Source-Drain Diode Forward Voltage

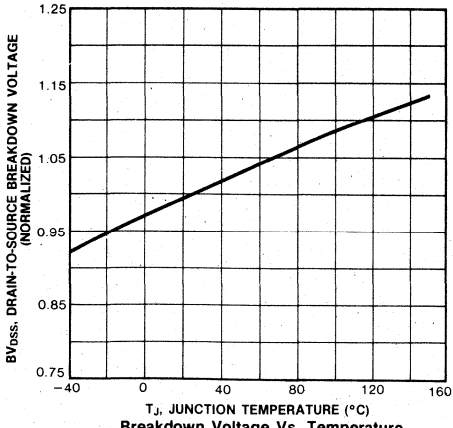

Breakdown Voltage Vs. Temperature

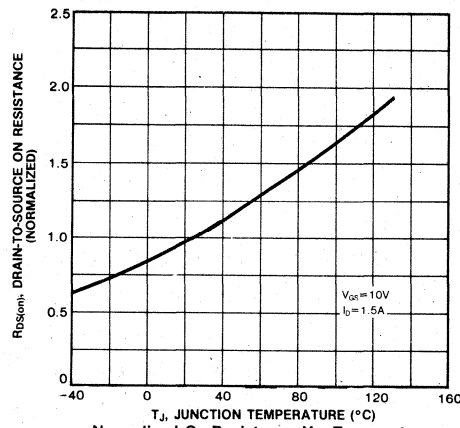

Normalized On-Resistance Vs. Temperature

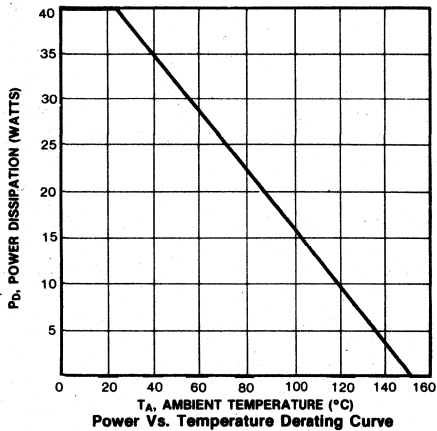
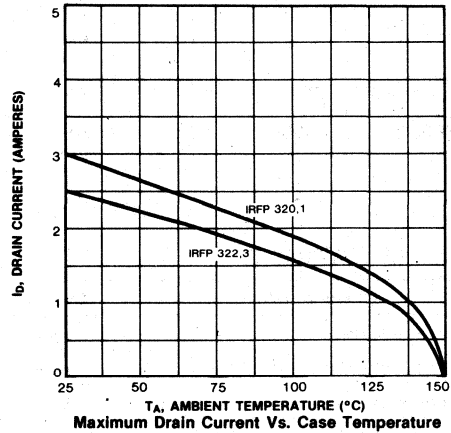
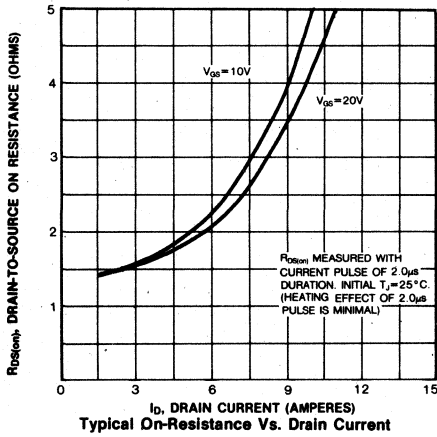
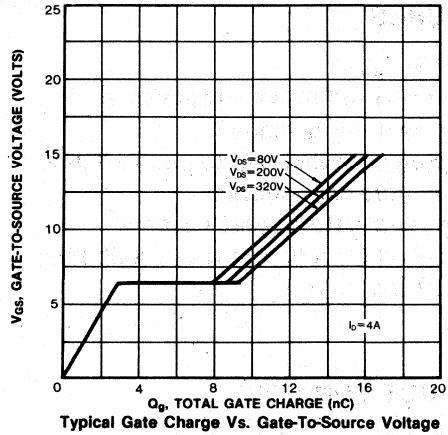
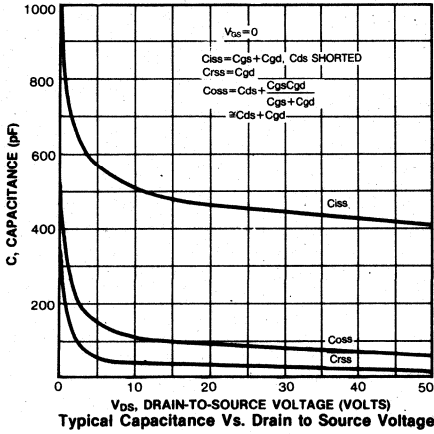

FEATURES

- Low $R_{DS(on)}$
- Improved inductive ruggedness
- Fast switching times
- Rugged polysilicon gate cell structure
- Low input capacitance
- Extended safe operating area
- Improved high temperature reliability
- TO-3P package

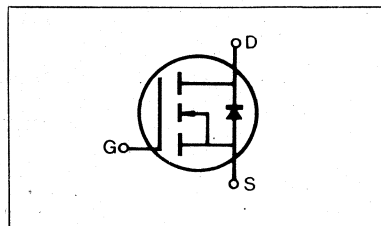
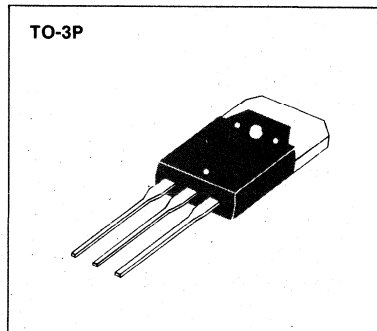

PRODUCT SUMMARY

Part Number	V_{DS}	$R_{DS(on)}$	I_D
IRFP330	400V	1.0 Ω	5.5A
IRFP331	350V	1.0 Ω	5.5A
IRFP332	400V	1.5 Ω	4.5A
IRFP333	350V	1.5 Ω	4.5A

MAXIMUM RATINGS

Characteristic	Symbol	IRFP330	IRFP331	IRFP332	IRFP333	Unit
Drain-Source Voltage (1)	V_{DSS}	400	350	400	350	Vdc
Drain-Gate Voltage ($R_{GS} = 1.0M\Omega$) (1)	V_{DGR}	400	350	400	350	Vdc
Gate-Source Voltage	V_{GS}	± 20				Vdc
Continuous Drain Current $T_C = 25^\circ C$	I_D	5.5	5.5	4.5	4.5	Adc
Continuous Drain Current $T_C = 100^\circ C$	I_D	3.5	3.5	3.0	3.0	Adc
Drain Current—Pulsed (3)	I_{DM}	22	22	18	18	Adc
Gate Current—Pulsed	I_{GM}	± 1.5				Adc
Total Power Dissipation @ $T_C = 25^\circ C$ Derate above $25^\circ C$	P_D	75 0.6				Watts W/ $^\circ C$
Operating and Storage Junction Temperature Range	T_J, T_{stg}	-55 to 150				$^\circ C$
Maximum Lead Temp. for Soldering Purposes, 1/8" from case for 5 seconds	T_L	300				$^\circ C$

Notes: (1) $T_J = 25^\circ C$ to $150^\circ C$

(2) Pulse test: Pulse width $\leq 300\mu s$, Duty Cycle $\leq 2\%$

(3) Repetitive rating: Pulse width limited by max. junction temperature

ELECTRICAL CHARACTERISTICS (T_C=25°C unless otherwise specified)

Characteristic	Symbol	Type	Min	Typ	Max	Units	Test Conditions
Drain-Source Breakdown Voltage	BV _{DSS}	IRFP330 IRFP332	400	—	—	V	V _{GS} =0V
		IRFP331 IRFP333	350	—	—	V	I _D =250μA
Gate Threshold Voltage	V _{GS(th)}	ALL	2.0	—	4.0	V	V _{DS} =V _{GS} , I _D =250μA
Gate-Source Leakage Forward	I _{GSS}	ALL	—	—	100	nA	V _{GS} =20V
Gate-Source Leakage Reverse	I _{GSS}	ALL	—	—	-100	nA	V _{GS} =-20V
Zero Gate Voltage Drain Current	I _{DSS}	ALL	—	—	250	μA	V _{DS} =Max. Rating, V _{GS} =0V
			—	—	1000	μA	V _{DS} =Max. Rating×0.8, V _{GS} =0V, T _C =125°C
On-State Drain-Source Current (2)	I _{D(on)}	IRFP330 IRFP331	5.5	—	—	A	V _{DS} >I _{D(on)} ×R _{DS(on) max.} , V _{GS} =10V
		IRFP332 IRFP333	4.5	—	—	A	
Static Drain-Source On-State Resistance (2)	R _{DS(on)}	IRFP330 IRFP331	—	0.8	1.0	Ω	V _{GS} =10V, I _D =3.0A
		IRFP332 IRFP333	—	1.0	1.5	Ω	
Forward Transconductance (2)	g _{fs}	ALL	3.0	4.4	—	Ω	V _{DS} >I _{D(on)} ×R _{DS(on) max.} , I _D =3.0A
Input Capacitance	C _{iss}	ALL	—	730	800	pF	V _{GS} =0V, V _{DS} =25V, f=1.0MHz
Output Capacitance	C _{oss}	ALL	—	100	300	pF	
Reverse Transfer Capacitance	C _{rss}	ALL	—	50	80	pF	
Turn-On Delay Time	t _{d(on)}	ALL	—	—	30	ns	V _{DD} =0.5BV _{DSS} , I _D =3.0A, Z ₀ =15Ω. (MOSFET switching times are essentially independent of operating temperature.)
Rise Time	t _r	ALL	—	—	35	ns	
Turn-Off Delay Time	t _{d(off)}	ALL	—	—	55	ns	
Fall Time	t _f	ALL	—	—	35	ns	
Total Gate Charge (Gate-Source Plus Gate-Drain)	Q _g	ALL	—	18	30	nC	V _{GS} =10V, I _D =7.0A, V _{DS} =0.8 Max. Rating (Gate charge is essentially independent of operating temperature.)
Gate-Source Charge	Q _{gs}	ALL	—	4.0	—	nC	
Gate-Drain ("Miller") Charge	Q _{gd}	ALL	—	14	—	nC	

THERMAL RESISTANCE

Junction-to-Case	R _{thJC}	ALL	—	—	1.67	K/W	
Case-to-Sink	R _{thCS}	ALL	—	0.1	—	K/W	Mounting surface flat, smooth, and greased
Junction-to-Ambient	R _{thJA}	ALL	—	—	80	K/W	Free Air Operation

Notes: (1) T_J=25°C to 150°C

(2) Pulse test: Pulse width≤300μs, Duty Cycle≤2%

(3) Repetitive rating: Pulse width limited by max. junction temperature

SOURCE-DRAIN DIODE RATINGS AND CHARACTERISTICS

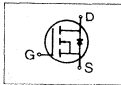
Characteristic	Symbol	Type	Min	Typ	Max	Units	Test Conditions
Continuous Source Current (Body Diode)	I_S	IRFP330	—	—	5.5	A	Modified MOSFET symbol showing the integral reverse P-N junction rectifier 
		IRFP332	—	—	4.5	A	
		IRFP333	—	—	4.5	A	
Pulse Source Current (Body Diode) (3)	I_{SM}	IRFP330	—	—	22	A	
		IRFP332	—	—	18	A	
		IRFP333	—	—	18	A	
Diode Forward Voltage (2)	V_{SD}	IRFP330	—	—	1.6	V	$T_C=25^\circ\text{C}$, $I_S=5.5\text{A}$, $V_{GS}=0\text{V}$
		IRFP331	—	—	1.6	V	$T_C=25^\circ\text{C}$, $I_S=5.5\text{A}$, $V_{GS}=0\text{V}$
		IRFP332	—	—	1.5	V	$T_C=25^\circ\text{C}$, $I_S=4.5\text{A}$, $V_{GS}=0\text{V}$
IRFP333	—	—	1.5	V	$T_C=25^\circ\text{C}$, $I_S=4.5\text{A}$, $V_{GS}=0\text{V}$		
Reverse Recovery Time	t_{rr}	ALL	—	600	—	ns	$T_J=150^\circ\text{C}$, $I_F=5.5\text{A}$, $dI_F/dt=100\text{A}/\mu\text{s}$

Notes: (1) $T_J=25^\circ\text{C}$ to 150°C (2) Pulse test: Pulse width $\leq 300\mu\text{s}$, Duty Cycle $\leq 2\%$
 (3) Repetitive rating: Pulse width limited by max. junction temperature

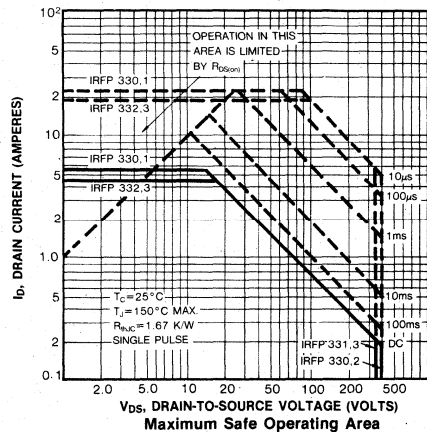
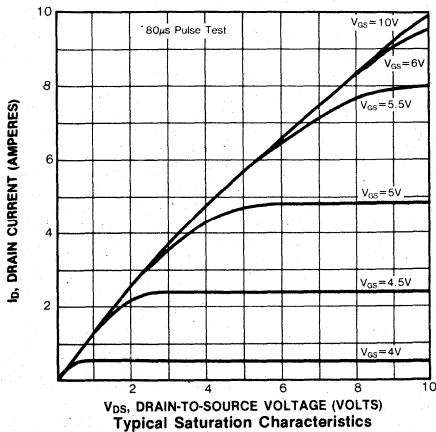
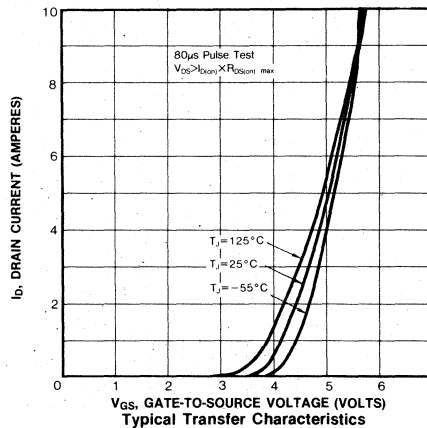
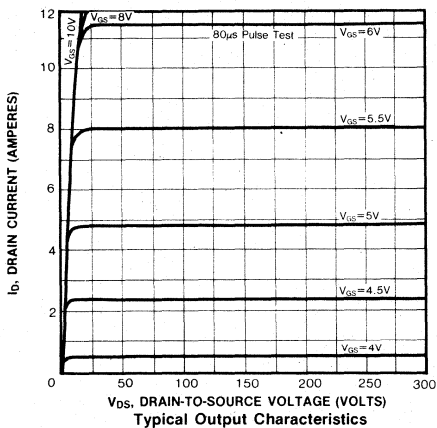

4

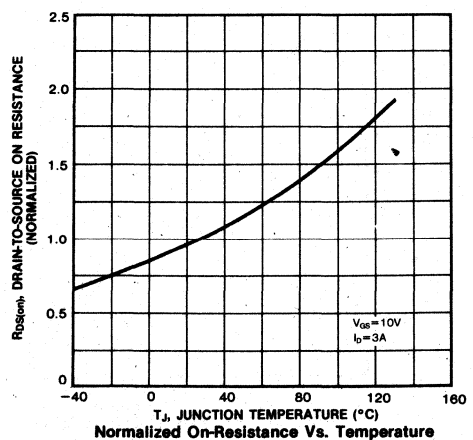
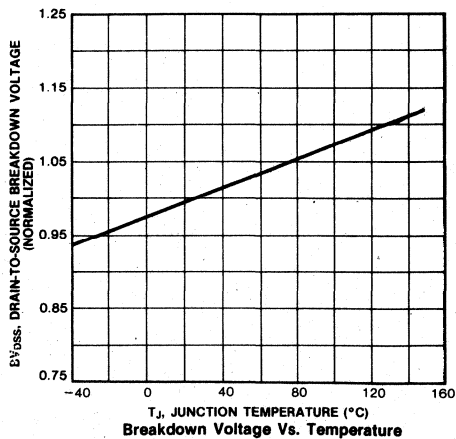
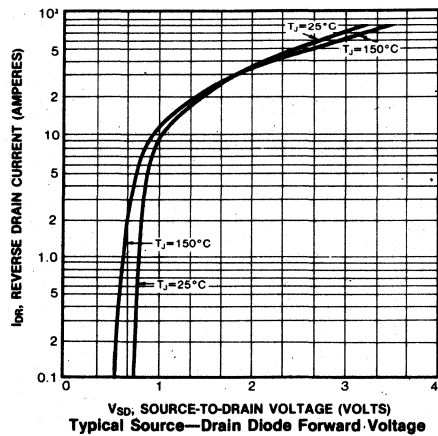
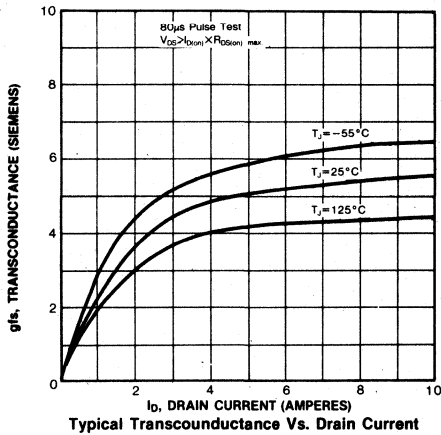
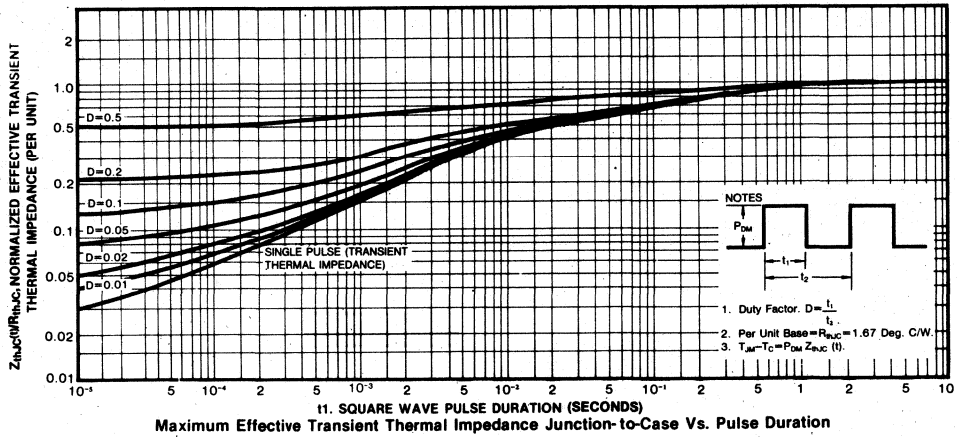

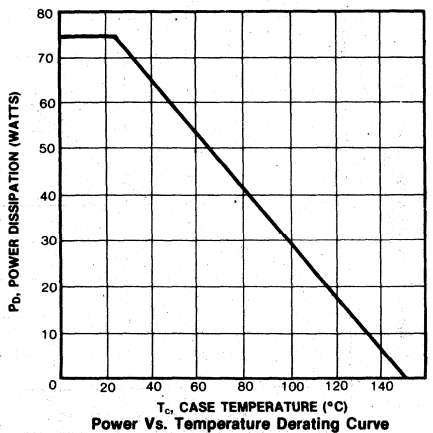
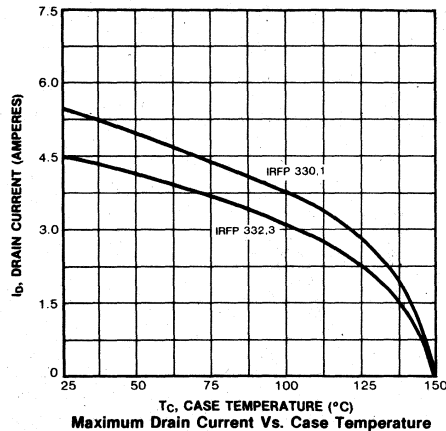
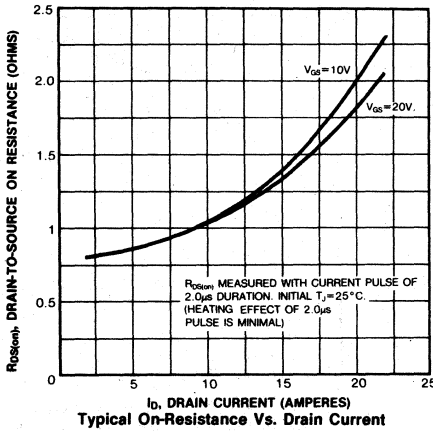
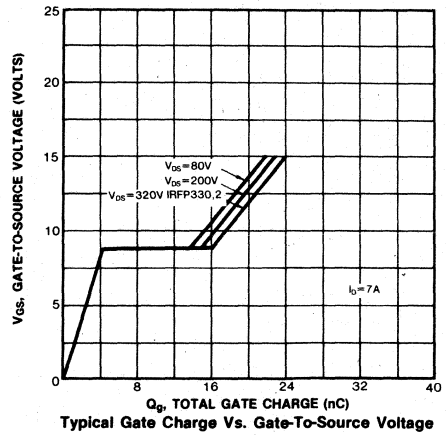
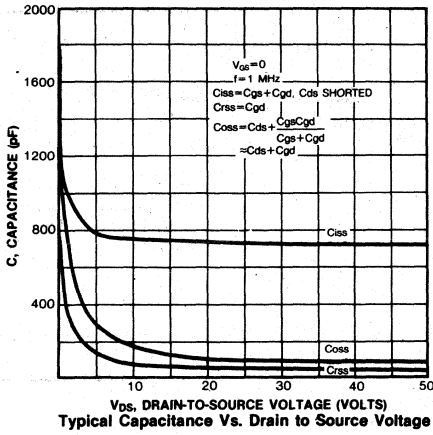

4

FEATURES

- Low $R_{DS(on)}$
- Improved inductive ruggedness
- Fast switching times
- Rugged polysilicon gate cell structure
- Low input capacitance
- Extended safe operating area
- Improved high temperature reliability
- TO-3P package

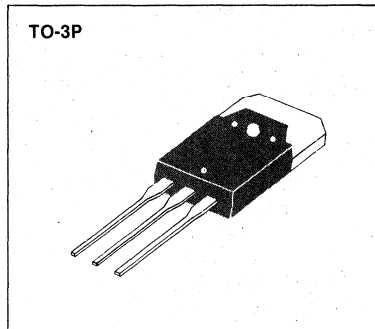

PRODUCT SUMMARY

Part Number	V_{DS}	$R_{DS(on)}$	I_D
IRFP340	400V	0.55 Ω	10A
IRFP341	350V	0.55 Ω	10A
IRFP342	400V	0.80 Ω	8.0A
IRFP343	350V	0.80 Ω	8.0A

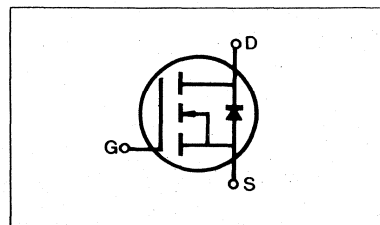

MAXIMUM RATINGS

Characteristic	Symbol	IRFP340	IRFP341	IRFP342	IRFP343	Unit
Drain-Source Voltage (1)	V_{DSS}	400	350	400	350	Vdc
Drain-Gate Voltage ($R_{GS}=1.0M\Omega$) (1)	V_{DGR}	400	350	400	350	Vdc
Gate-Source Voltage	V_{GS}	±20				Vdc
Continuous Drain Current $T_C=25^\circ C$	I_D	10	10	8.0	8.0	Adc
Continuous Drain Current $T_C=100^\circ C$	I_D	6.0	6.0	5.0	5.0	Adc
Drain Current—Pulsed (3)	I_{DM}	40	40	32	32	Adc
Gate Current—Pulsed	I_{GM}	±1.5				Adc
Total Power Dissipation @ $T_C=25^\circ C$ Derate above $25^\circ C$	P_D	125 1.0				Watts W/ $^\circ C$
Operating and Storage Junction Temperature Range	T_J, T_{stg}	-55 to 150				$^\circ C$
Maximum Lead Temp. for Soldering Purposes, 1/8" from case for 5 seconds	T_L	300				$^\circ C$

Notes: (1) $T_J=25^\circ C$ to $150^\circ C$

(2) Pulse test: Pulse width $\leq 300\mu s$, Duty Cycle $\leq 2\%$

(3) Repetitive rating: Pulse width limited by max. junction temperature

ELECTRICAL CHARACTERISTICS (T_C=25°C unless otherwise specified)

Characteristic	Symbol	Type	Min	Typ	Max	Units	Test Conditions
Drain-Source Breakdown Voltage	BV _{DSS}	IRFP340 IRFP342	400	—	—	V	V _{GS} =0V
		IRFP341 IRFP343	350	—	—	V	I _D =250μA
Gate Threshold Voltage	V _{GS(th)}	ALL	2.0	—	4.0	V	V _{DS} =V _{GS} , I _D =250μA
Gate-Source Leakage Forward	I _{GSS}	ALL	—	—	100	nA	V _{GS} =20V
Gate-Source Leakage Reverse	I _{GSS}	ALL	—	—	-100	nA	V _{GS} =-20V
Zero Gate Voltage Drain Current	I _{DSS}	ALL	—	—	250	μA	V _{DS} =Max. Rating, V _{GS} =0V
			—	—	1000	μA	V _{DS} =Max. Rating×0.8, V _{GS} =0V, T _C =125°C
On-State Drain-Source Current (2)	I _{D(on)}	IRFP340 IRFP341	10	—	—	A	V _{DS} >I _{D(on)} ×R _{DS(on) max.} , V _{GS} =10V
		IRFP342 IRFP343	8.0	—	—	A	
Static Drain-Source On-State Resistance (2)	R _{DS(on)}	IRFP340 IRFP341	—	0.30	0.55	Ω	V _{GS} =10V, I _D =5.0A
		IRFP342 IRFP343	—	0.68	0.80	Ω	
Forward Transconductance (2)	g _{fs}	ALL	4.0	7.0	—	Ω	V _{DS} >I _{D(on)} ×R _{DS(on) max.} , I _D =5.0A
Input Capacitance	C _{iss}	ALL	—	1300	1600	pF	V _{GS} =0V, V _{DS} =25V, f=1.0MHz
Output Capacitance	C _{oss}	ALL	—	250	450	pF	
Reverse Transfer Capacitance	C _{rss}	ALL	—	50	150	pF	V _{DD} =0.5BV _{DSS} , I _D =5.0A, Z _O =4.7 Ω (MOSFET switching times are essentially independent of operating temperature.)
Turn-On Delay Time	t _{d(on)}	ALL	—	—	35	ns	
Rise Time	t _r	ALL	—	—	15	ns	
Turn-Off Delay Time	t _{d(off)}	ALL	—	—	90	ns	
Fall Time	t _f	ALL	—	—	35	ns	V _{GS} =10V, I _D =12A, V _{DS} =0.8 Max. Rating (Gate charge is essentially independent of operating temperature.)
Total Gate Charge (Gate-Source Plus Gate-Drain)	Q _g	ALL	—	41	60	nC	
Gate-Source Charge	Q _{gs}	ALL	—	6.0	—	nC	
Gate-Drain ("Miller") Charge	Q _{gd}	ALL	—	35	—	nC	

THERMAL RESISTANCE

Junction-to-Case	R _{thJC}	ALL	—	—	1.0	K/W	
Case-to-Sink	R _{thCS}	ALL	—	0.1	—	K/W	Mounting surface flat, smooth, and greased
Junction-to-Ambient	R _{thJA}	ALL	—	—	80	K/W	Free Air Operation

- Notes:** (1) T_J=25°C to 150°C
 (2) Pulse test: Pulse width≤300μs, Duty Cycle≤2%
 (3) Repetitive rating: Pulse width limited by max. junction temperature

SOURCE-DRAIN DIODE RATINGS AND CHARACTERISTICS

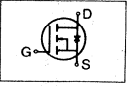
Characteristic	Symbol	Type	Min	Typ	Max	Units	Test Conditions
Continuous Source Current (Body Diode)	I_S	IRFP340	—	—	10	A	Modified MOSFET symbol showing the integral reverse P-N junction rectifier 
		IRFP341	—	—	10	A	
		IRFP342	—	—	8.0	A	
Pulse Source Current (Body Diode) (3)	I_{SM}	IRFP340	—	—	40	A	
		IRFP341	—	—	40	A	
		IRFP342	—	—	32	A	
Diode Forward Voltage (2)	V_{SD}	IRFP340	—	—	2.0	V	$T_C=25^\circ\text{C}$, $I_S=10\text{A}$, $V_{GS}=0\text{V}$
		IRFP341	—	—	2.0	V	$T_C=25^\circ\text{C}$, $I_S=10\text{A}$, $V_{GS}=0\text{V}$
		IRFP342	—	—	1.9	V	$T_C=25^\circ\text{C}$, $I_S=8.0\text{A}$, $V_{GS}=0\text{V}$
Reverse Recovery Time	t_{rr}	ALL	—	800	—	ns	$T_J=150^\circ\text{C}$, $I_F=10\text{A}$, $dI_F/dt=100\text{A}/\mu\text{s}$

Notes: (1) $T_J=25^\circ\text{C}$ to 150°C (2) Pulse test: pulse width $\leq 300\mu\text{s}$, Duty Cycle $\leq 2\%$
 (3) Repetitive rating: Pulse width limited by max. junction temperature

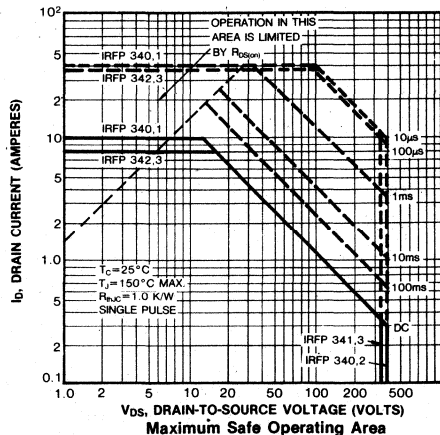
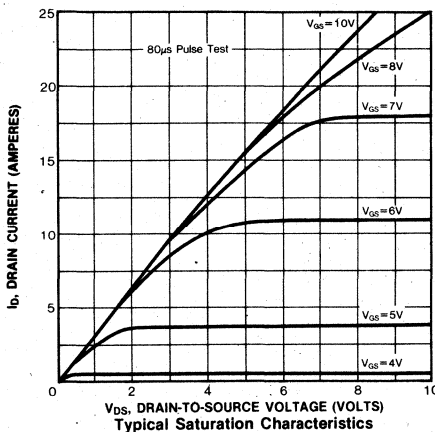
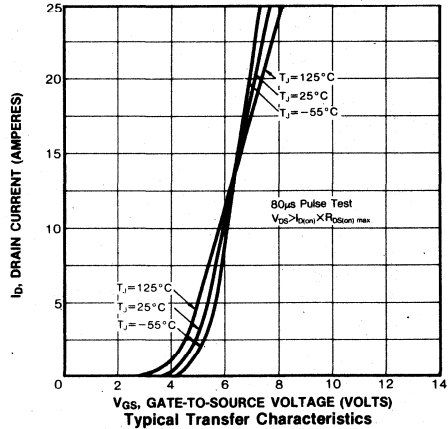
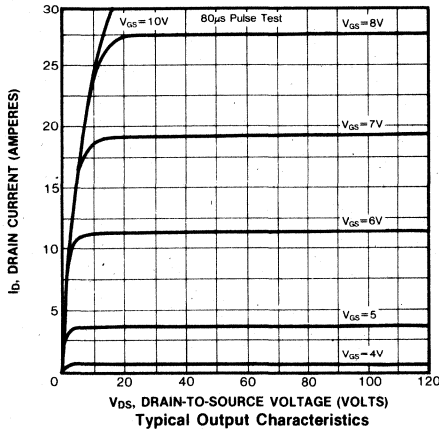

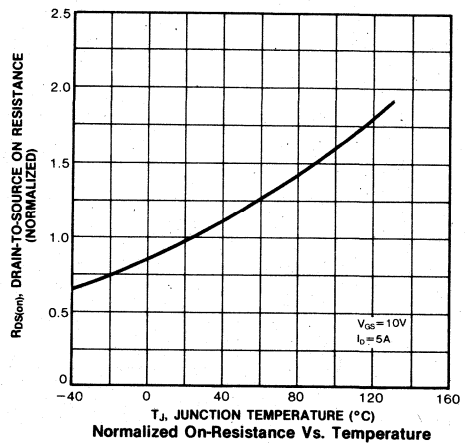
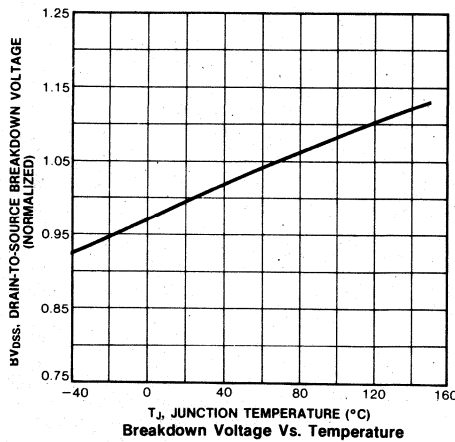
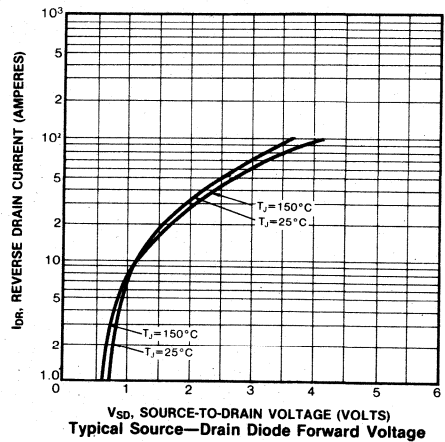
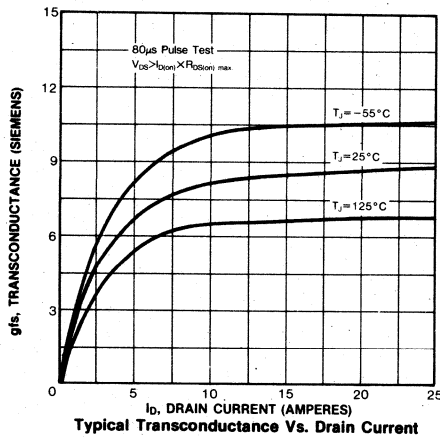
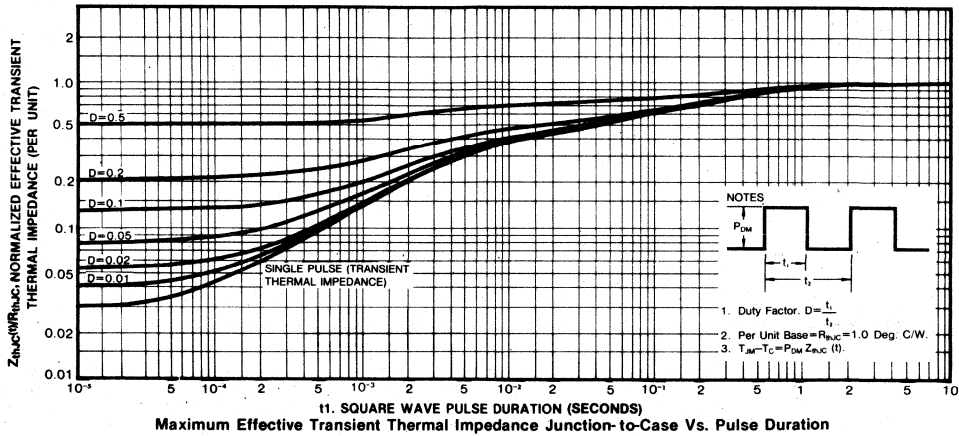

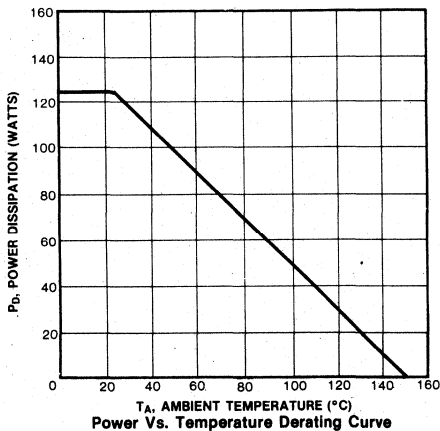
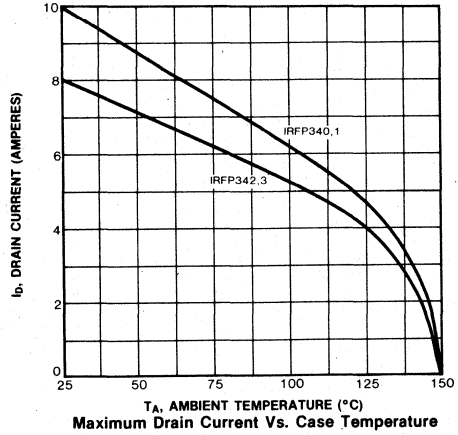
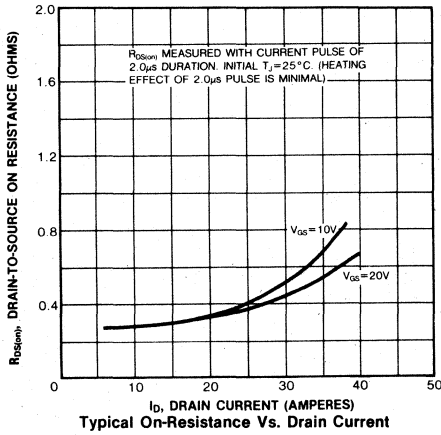
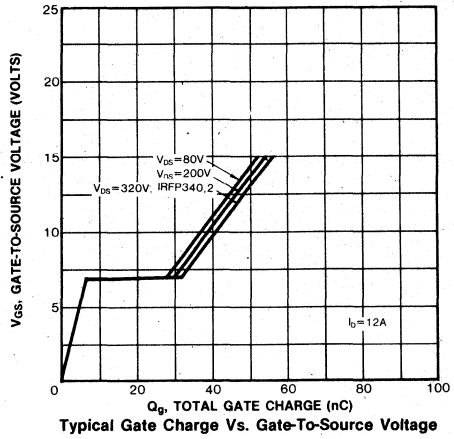
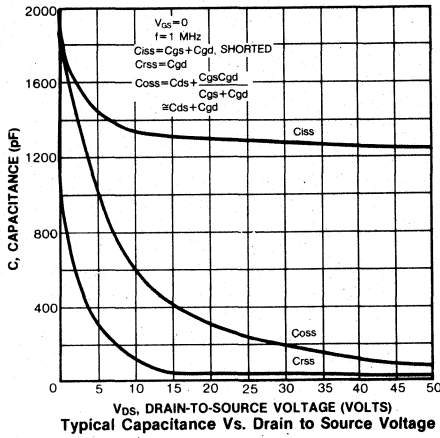

FEATURES

- Low $R_{DS(on)}$
- Improved inductive ruggedness
- Fast switching times
- Rugged polysilicon gate cell structure
- Low input capacitance
- Extended safe operating area
- Improved high temperature reliability
- TO-3P package

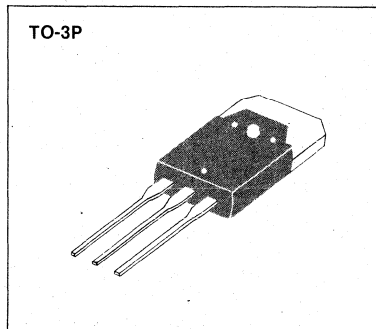

PRODUCT SUMMARY

Part Number	V_{DS}	$R_{DS(on)}$	I_D
IRFP350	400V	0.3 Ω	15A
IRFP351	350V	0.3 Ω	15A
IRFP352	400V	0.4 Ω	13A
IRFP353	350V	0.4 Ω	13A

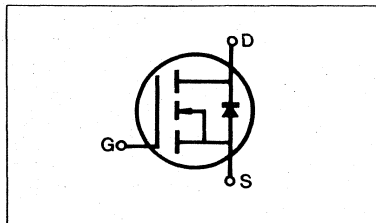

MAXIMUM RATINGS

Characteristic	Symbol	IRFP350	IRFP351	IRFP352	IRFP353	Unit
Drain-Source Voltage (1)	V_{DSS}	400	350	400	350	Vdc
Drain-Gate Voltage ($R_{GS}=1.0M\Omega$) (1)	V_{DGR}	400	350	400	350	Vdc
Gate-Source Voltage	V_{GS}	± 20				Vdc
Continuous Drain Current $T_C=25^\circ C$	I_D	15	15	13	13	Adc
Continuous Drain Current $T_C=100^\circ C$	I_D	9.0	9.0	8.0	8.0	Adc
Drain Current—Pulsed (3)	I_{DM}	60	60	52	52	Adc
Gate Current—Pulsed	I_{GM}	± 1.5				Adc
Total Power Dissipation @ $T_C=25^\circ C$ Derate above $25^\circ C$	P_D	150 1.2				Watts W/ $^\circ C$
Operating and Storage Junction Temperature Range	T_J, T_{stg}	-55 to 150				$^\circ C$
Maximum Lead Temp. for Soldering Purposes, 1/8" from case for 5 seconds	T_L	300				$^\circ C$

- Notes: (1) $T_J=25^\circ C$ to $150^\circ C$
 (2) Pulse test: Pulse width $\leq 300\mu s$, Duty Cycle $\leq 2\%$
 (3) Repetitive rating: Pulse width limited by max. junction temperature

ELECTRICAL CHARACTERISTICS (T_C=25°C unless otherwise specified)

Characteristic	Symbol	Type	Min	Typ	Max	Units	Test Conditions
Drain-Source Breakdown Voltage	BV _{DSS}	IRFP350 IRFP352	400	—	—	V	V _{GS} =0V
		IRFP351 IRFP353	350	—	—	V	I _D =250μA
Gate Threshold Voltage	V _{GS(th)}	ALL	2.0	—	4.0	V	V _{DS} =V _{GS} , I _D =250μA
Gate-Source Leakage Forward	I _{GSS}	ALL	—	—	100	nA	V _{GS} =20V
Gate-Source Leakage Reverse	I _{GSS}	ALL	—	—	-100	nA	V _{GS} =-20V
Zero Gate Voltage Drain Current	I _{DSS}	ALL	—	—	250	μA	V _{DS} =Max. Rating, V _{GS} =0V
			—	—	1000	μA	V _{DS} =Max. Rating×0.8, V _{GS} =0V, T _C =125°C
On-State Drain-Source Current (2)	I _{D(on)}	IRFP350 IRFP351	15	—	—	A	V _{DS} >I _{D(on)} ×R _{DS(on)} max., V _{GS} =10V
		IRFP352 IRFP353	13	—	—	A	
Static Drain-Source On-State Resistance (2)	R _{DS(on)}	IRFP350 IRFP351	—	0.25	0.3	Ω	V _{GS} =10V, I _D =8.0A
		IRFP352 IRFP353	—	0.3	0.4	Ω	
Forward Transconductance (2)	g _{fs}	ALL	8.0	11	—	S	V _{DS} >I _{D(on)} ×R _{DS(on)} max., I _D =8.0A
Input Capacitance	C _{iss}	ALL	—	2630	3000	pF	V _{GS} =0V, V _{DS} =25V, f=1.0MHz
Output Capacitance	C _{oss}	ALL	—	390	600	pF	
Reverse Transfer Capacitance	C _{rss}	ALL	—	130	200	pF	
Turn-On Delay Time	t _{d(on)}	ALL	—	—	35	ns	V _{DD} =0.5BV _{DSS} , I _D =8.0A, Z _O =4.7 Ω (MOSFET switching times are essentially independent of operating temperature.)
Rise Time	t _r	ALL	—	—	65	ns	
Turn-Off Delay Time	t _{d(off)}	ALL	—	—	150	ns	
Fall Time	t _f	ALL	—	—	75	ns	
Total Gate Charge (Gate-Source Plus Gate-Drain)	Q _g	ALL	—	73	120	nC	V _{GS} =10V, I _D =18A, V _{DS} =0.8 Max. Rating (Gate charge is essentially independent of operating temperature. See Fig. 8 page 21)
Gate-Source Charge	Q _{gs}	ALL	—	14	—	nC	
Gate-Drain ("Miller") Charge	Q _{gd}	ALL	—	59	—	nC	

THERMAL RESISTANCE

Junction-to-Case	R _{thJC}	ALL	—	—	0.83	K/W	
Case-to-Sink	R _{thCS}	ALL	—	0.1	—	K/W	Mounting surface flat, smooth, and greased
Junction-to-Ambient	R _{thJA}	ALL	—	—	80	K/W	Free Air Operation

- Notes:** (1) T_J=25°C to 150°C
 (2) Pulse test: Pulse width≤300μs, Duty Cycle≤2%
 (3) Repetitive rating: Pulse width limited by max. junction temperature

SOURCE-DRAIN DIODE RATINGS AND CHARACTERISTICS

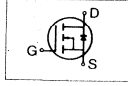
Characteristic	Symbol	Type	Min	Typ	Max	Units	Test Conditions
Continuous Source Current (Body Diode)	I_S	IRFP350	—	—	15	A	Modified MOSFET symbol showing the integral reverse P-N junction rectifier 
		IRFP351	—	—	13	A	
		IRFP352	—	—	13	A	
		IRFP353	—	—	13	A	
Pulse Source Current (Body Diode) (3)	I_{SM}	IRFP350	—	—	60	A	
		IRFP351	—	—	60	A	
		IRFP352 IRFP353	—	—	52	A	
Diode Forward Voltage (2)	V_{SD}	IRFP350 IRFP351	—	—	1.6	V	$T_C=25^\circ\text{C}$, $I_S=15\text{A}$, $V_{GS}=0\text{V}$
		IRFP352 IRFP353	—	—	1.5	V	$T_C=25^\circ\text{C}$, $I_S=13\text{A}$, $V_{GS}=0\text{V}$
		ALL	—	1000	—	ns	$T_J=150^\circ\text{C}$, $I_F=15\text{A}$, $dI_F/dt=100\text{A}/\mu\text{s}$

Notes: (1) $T_J=25^\circ\text{C}$ to 150°C (2) Pulse test: Pulse width $\leq 300\mu\text{s}$, Duty Cycle $\leq 2\%$
 (3) Repetitive rating: Pulse width limited by max. junction temperature

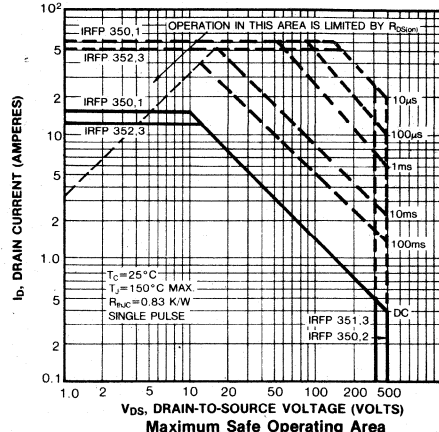
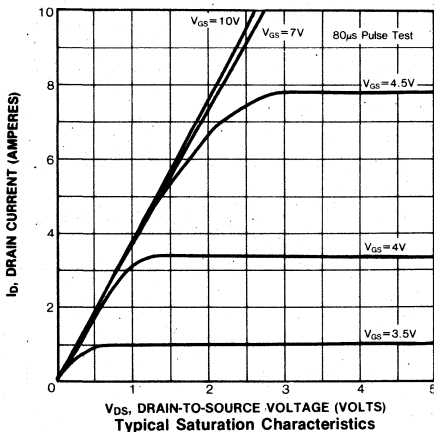
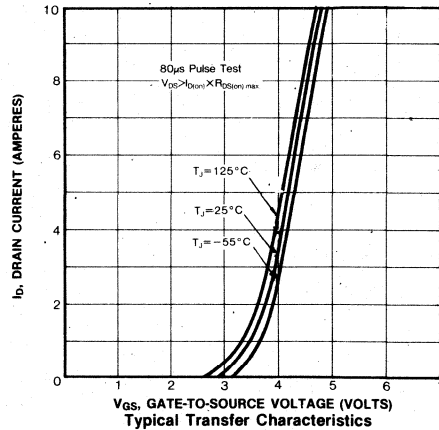
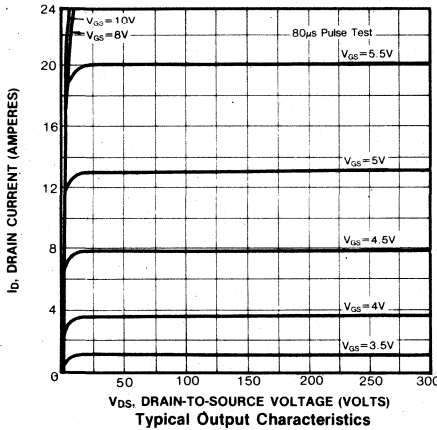

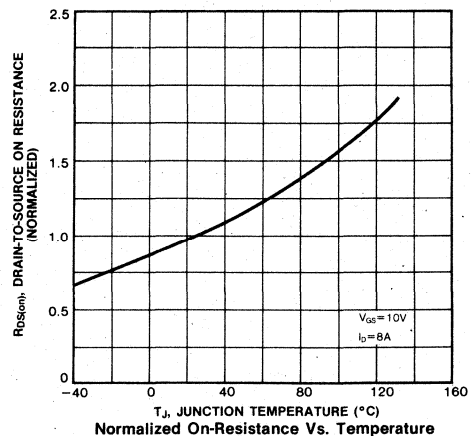
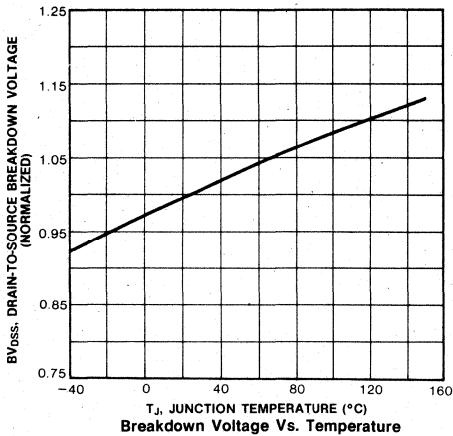
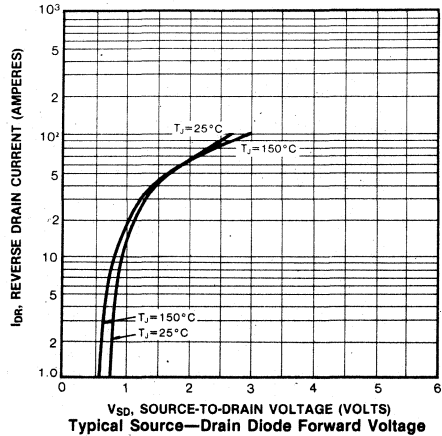
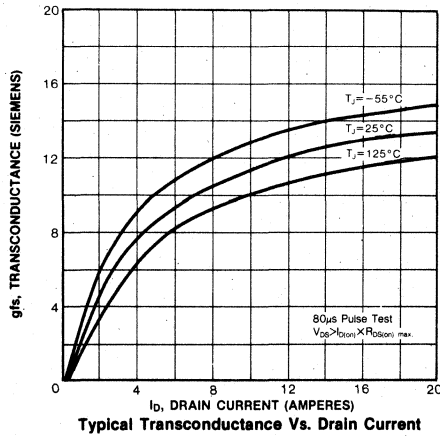
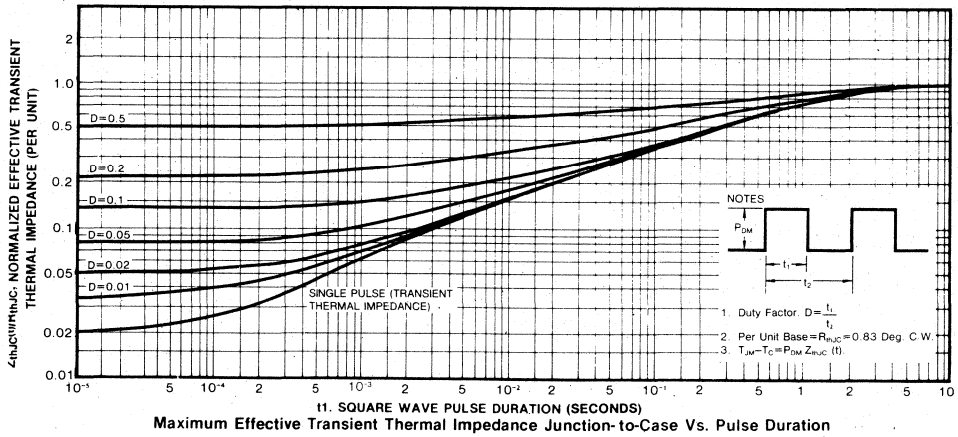

IRFP350/351/352/353

N-CHANNEL POWER MOSFETS

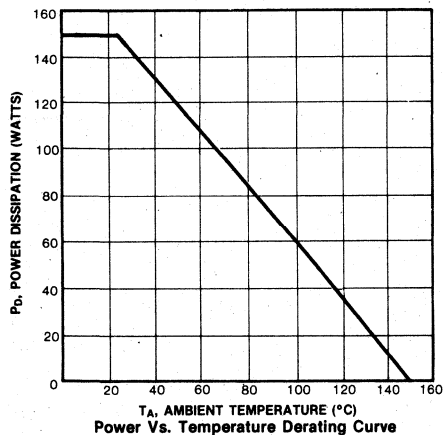
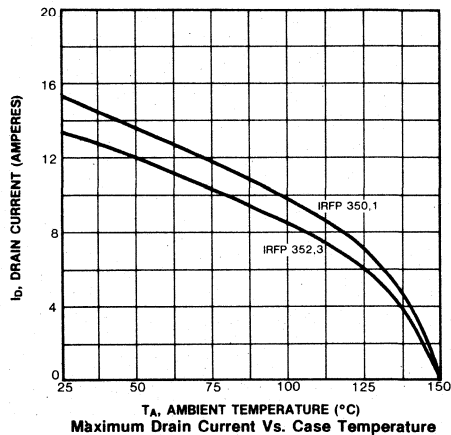
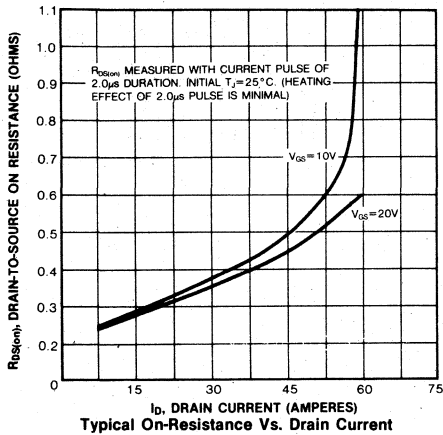
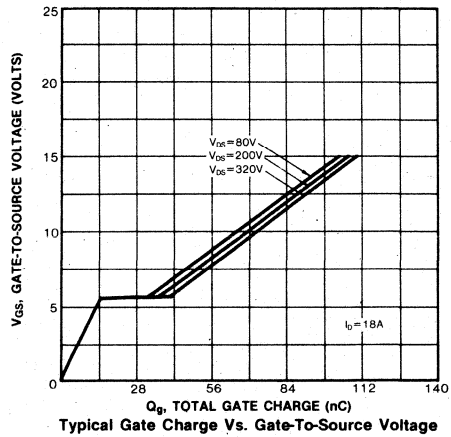
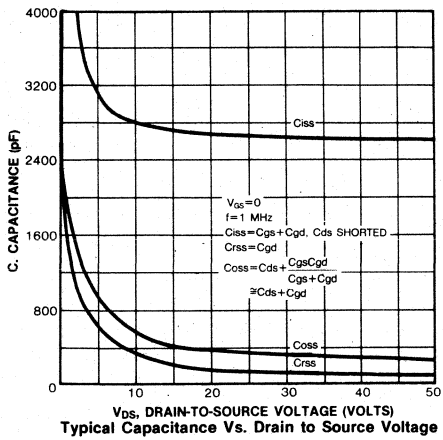

4

FEATURES

- Low $R_{DS(on)}$ at high voltage
- Improved inductive ruggedness
- Excellent high voltage stability
- Fast switching times
- Rugged polysilicon gate cell structure
- Low input capacitance
- Extended safe operating area
- Improved high temperature reliability
- TO-3P package

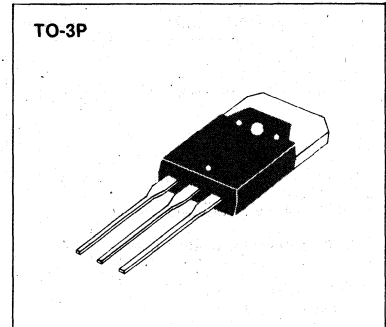

PRODUCT SUMMARY

Part Number	V_{DS}	$R_{DS(on)}$	I_D
IRFP420	500V	3.0 Ω	2.5A
IRFP421	450V	3.0 Ω	2.5A
IRFP422	500V	4.0 Ω	2.0A
IRFP423	450V	4.0 Ω	2.0A

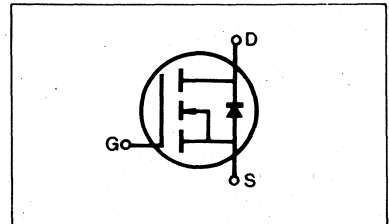

MAXIMUM RATINGS

Characteristic	Symbol	IRFP420	IRFP421	IRFP422	IRFP423	Unit
Drain-Source Voltage (1)	V_{DSS}	500	450	500	450	Vdc
Drain-Gate Voltage ($R_{GS}=1.0M\Omega$) (1)	V_{DGR}	500	450	500	450	Vdc
Gate-Source Voltage	V_{GS}	± 20				Vdc
Continuous Drain Current $T_C=25^\circ C$	I_D	2.5	2.5	2.0	2.0	Adc
Continuous Drain Current $T_C=100^\circ C$	I_D	1.5	1.5	1.0	1.0	Adc
Drain Current—Pulsed (3)	I_{DM}	10	10	8.0	8.0	Adc
Gate Current—Pulsed	I_{GM}	± 1.5				Adc
Total Power Dissipation @ $T_C=25^\circ C$ Derate above $25^\circ C$	P_D	40 0.32				Watts W/ $^\circ C$
Operating and Storage Junction Temperature Range	T_J, T_{stg}	-55 to 150				$^\circ C$
Maximum Lead Temp. for Soldering Purposes, 1/8" from case for 5 seconds	T_L	300				$^\circ C$

- Notes: (1) $T_J=25^\circ C$ to $150^\circ C$
 (2) Pulse test: Pulse width $\leq 300\mu s$, Duty Cycle $\leq 2\%$
 (3) Repetitive rating: Pulse width limited by max. junction temperature

ELECTRICAL CHARACTERISTICS ($T_C=25^\circ\text{C}$ unless otherwise specified)

Characteristic	Symbol	Type	Min	Typ	Max	Units	Test Conditions
Drain-Source Breakdown Voltage	BV _{DSS}	IRFP420 IRFP422	500	—	—	V	V _{GS} =0V
		IRFP421 IRFP423	450	—	—	V	I _D =250μA
Gate Threshold Voltage	V _{GS(th)}	ALL	2.0	—	4.0	V	V _{DS} =V _{GS} , I _D =250μA
Gate-Source Leakage Forward	I _{GSS}	ALL	—	—	100	nA	V _{GS} =20V
Gate-Source Leakage Reverse	I _{GSS}	ALL	—	—	-100	nA	V _{GS} =-20V
Zero Gate Voltage Drain Current	I _{DSS}	ALL	—	—	250	μA	V _{DS} =Max. Rating, V _{GS} =0V
			—	—	1000	μA	V _{DS} =Max. Rating×0.8, V _{GS} =0V, T _C =125°C
On-State Drain-Source Current (2)	I _{D(on)}	IRFP420 IRFP421	2.5	—	—	A	V _{DS} >I _{D(on)} ×R _{DS(on) max.} , V _{GS} =10V
		IRFP422 IRFP423	2.0	—	—	A	
Static Drain-Source On-State Resistance (2)	R _{DS(on)}	IRFP420 IRFP421	—	2.5	3.0	Ω	V _{GS} =10V, I _D =1.0A
		IRFP422 IRFP423	—	3.0	4.0	Ω	
Forward Transconductance (2)	g _{fs}	ALL	1.0	1.75	—	Ω	V _{DS} >I _{D(on)} ×R _{DS(on) max.} , I _D =1.0A
Input Capacitance	C _{iss}	ALL	—	300	600	pF	V _{GS} =0V, V _{DS} =25V, f=1.0MHz
Output Capacitance	C _{oss}	ALL	—	75	150	pF	
Reverse Transfer Capacitance	C _{rss}	ALL	—	20	40	pF	
Turn-On Delay Time	t _{d(on)}	ALL	—	—	60	ns	
Rise Time	t _r	ALL	—	—	50	ns	V _{DD} =0.5BV _{DSS} , I _D =1.0A, Z _O =50Ω, (MOSFET switching times are essentially independent of operating temperature.)
Turn-Off Delay Time	t _{d(off)}	ALL	—	—	60	ns	
Fall Time	t _f	ALL	—	—	30	ns	
Total Gate Charge (Gate-Source Plus Gate-Drain)	Q _g	ALL	—	11	15	nC	V _{GS} =10V, I _D =3.0A, V _{DS} =0.8 Max. Rating (Gate charge is essentially independent of operating temperature.)
Gate-Source Charge	Q _{gs}	ALL	—	5.0	—	nC	
Gate-Drain ("Miller") Charge	Q _{gd}	ALL	—	6.0	—	nC	

4

THERMAL RESISTANCE

Junction-to-Case	R _{thJC}	ALL	—	—	3.12	K/W	
Case-to-Sink	R _{thCS}	ALL	—	0.1	—	K/W	Mounting surface flat, smooth, and greased
Junction-to-Ambient	R _{thJA}	ALL	—	—	80	K/W	Free Air Operation

- Notes:** (1) T_J=25°C to 150°C
 (2) Pulse test: Pulse width≤300μs, Duty Cycle≤2%
 (3) Repetitive rating: Pulse width limited by max. junction temperature

SOURCE-DRAIN DIODE RATINGS AND CHARACTERISTICS

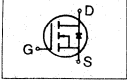
Characteristic	Symbol	Type	Min	Typ	Max	Units	Test Conditions
Continuous Source Current (Body Diode)	I_S	IRFP420	—	—	2.5	A	Modified MOSFET symbol showing the integral reverse P-N junction rectifier 
		IRFP421	—	—	2.5	A	
		IRFP422	—	—	2.0	A	
		IRFP423	—	—	2.0	A	
Pulse Source Current (Body Diode) (3)	I_{SM}	IRFP420	—	—	10	A	
		IRFP421	—	—	10	A	
		IRFP422 IRFP423	—	—	8.0	A	
Diode Forward Voltage (2)	V_{SD}	IRFP420	—	—	1.4	V	$T_C=25^\circ\text{C}$, $I_S=2.5\text{A}$, $V_{GS}=0\text{V}$
		IRFP421	—	—	1.4	V	$T_C=25^\circ\text{C}$, $I_S=2.5\text{A}$, $V_{GS}=0\text{V}$
		IRFP422 IRFP423	—	—	1.3	V	$T_C=25^\circ\text{C}$, $I_S=2.0\text{A}$, $V_{GS}=0\text{V}$
Reverse Recovery Time	t_{rr}	ALL	—	600	—	ns	$T_J=150^\circ\text{C}$, $I_F=2.5\text{A}$, $di/dt=100\text{A}/\mu\text{s}$

Notes: (1) $T_J=25^\circ\text{C}$ to 150°C (2) Pulse test: Pulse width $\leq 300\mu\text{s}$, Duty Cycle $\leq 2\%$
 (3) Repetitive rating: Pulse width limited by max. junction temperature

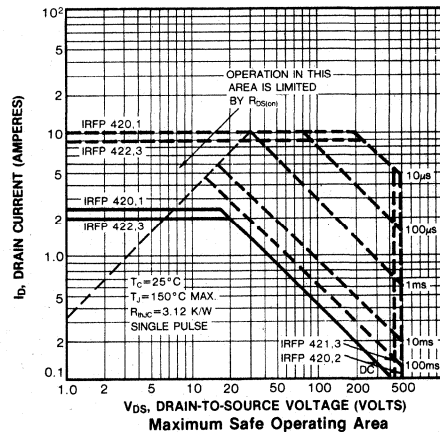
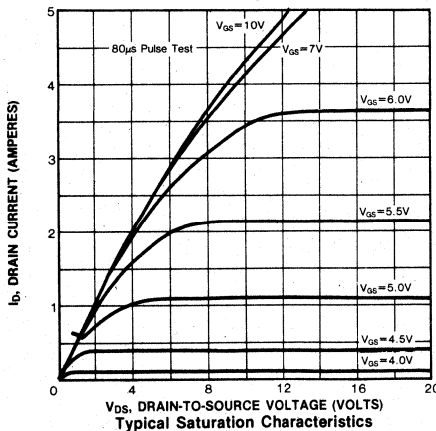
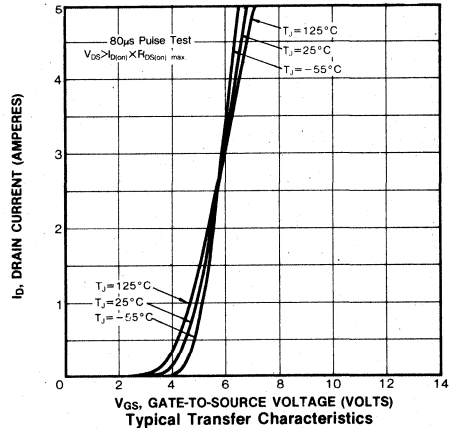
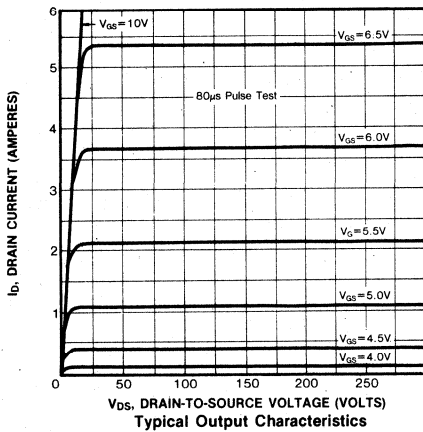

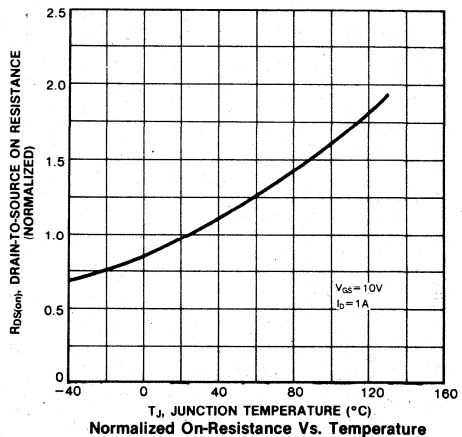
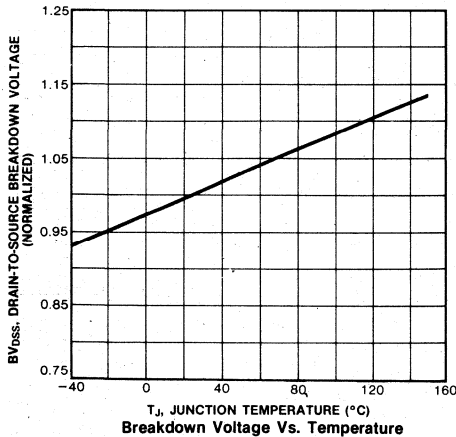
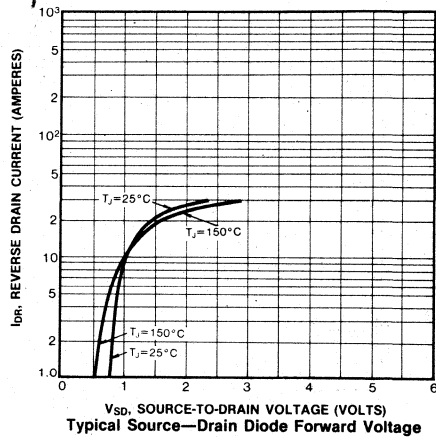
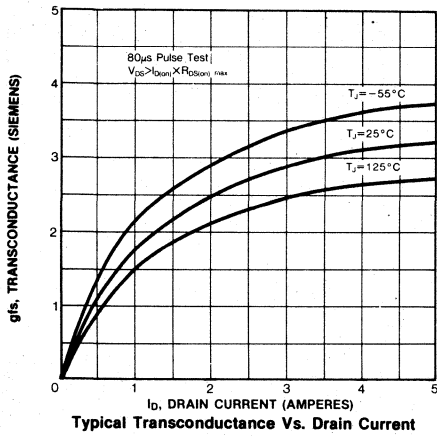
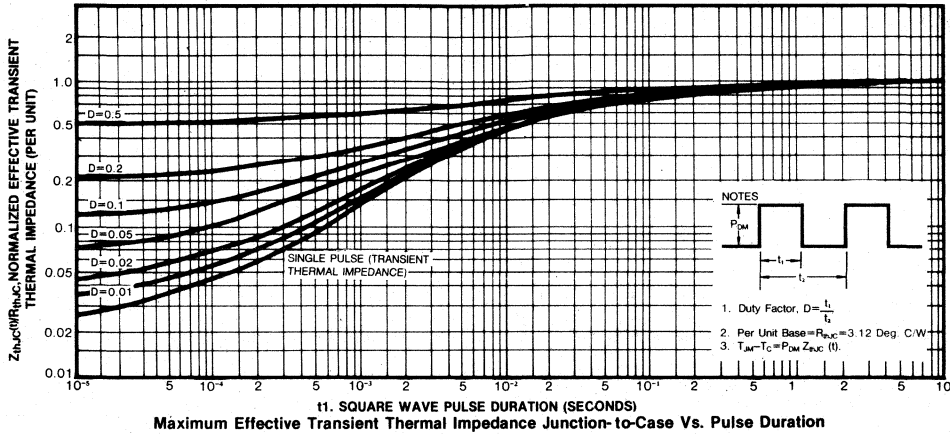

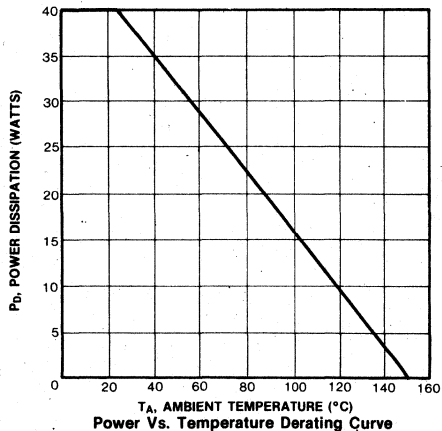
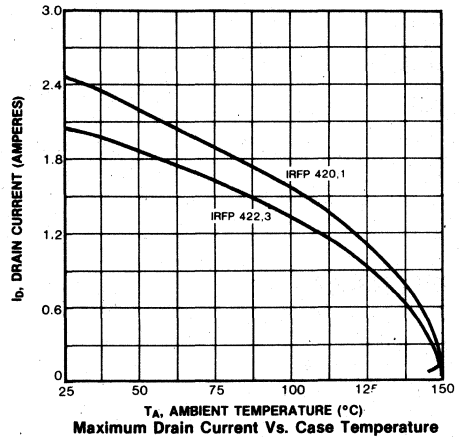
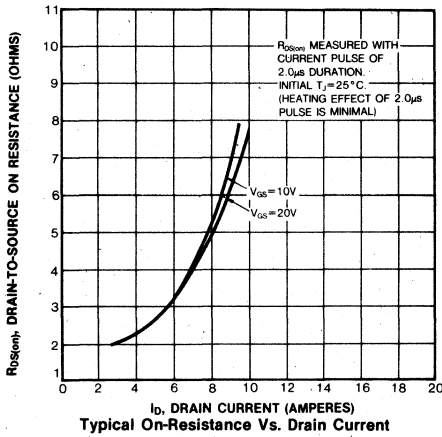
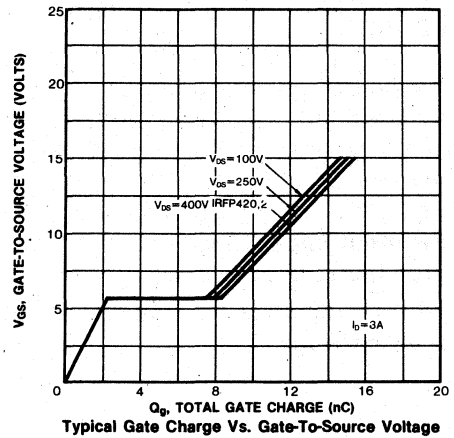
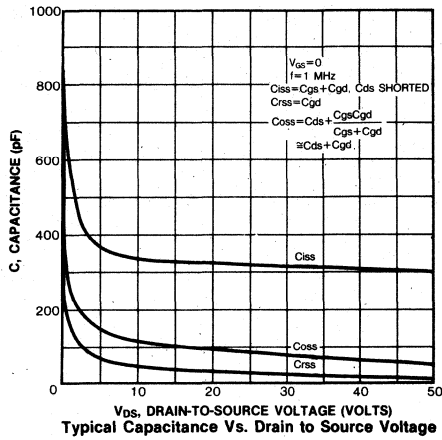

IRFP430/431/432/433

N-CHANNEL POWER MOSFETS

FEATURES

- Low $R_{DS(on)}$ at high voltage
- Improved inductive ruggedness
- Excellent high voltage stability
- Fast switching times
- Rugged polysilicon gate cell structure
- Low input capacitance
- Extended safe operating area
- Improved high temperature reliability
- TO-3P package

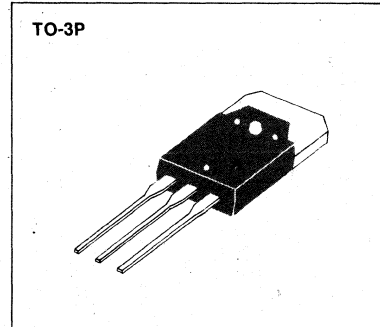

PRODUCT SUMMARY

Part Number	V_{DS}	$R_{DS(on)}$	I_D
IRFP430	500V	1.5Ω	4.5A
IRFP431	450V	1.5Ω	4.5A
IRFP432	500V	2.0Ω	4.0A
IRFP433	450V	2.0Ω	4.0A

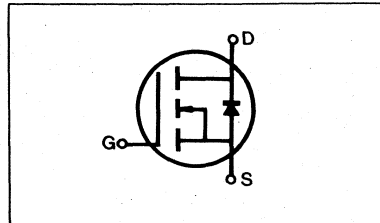

MAXIMUM RATINGS

Characteristic	Symbol	IRFP430	IRFP431	IRFP432	IRFP433	Unit
Drain-Source Voltage (1)	V_{DSS}	500	450	500	450	Vdc
Drain-Gate Voltage ($R_{GS}=1.0M\Omega$) (1)	V_{DGR}	500	450	500	450	Vdc
Gate-Source Voltage	V_{GS}	±20				Vdc
Continuous Drain Current $T_C=25^\circ C$	I_D	4.5	4.5	4.0	4.0	Adc
Continuous Drain Current $T_C=100^\circ C$	I_D	3.0	3.0	2.5	2.5	Adc
Drain Current—Pulsed (3)	I_{DM}	18	18	16	16	Adc
Gate Current—Pulsed	I_{GM}	±1.5				Adc
Total Power Dissipation @ $T_C=25^\circ C$ Derate above $25^\circ C$	P_D	75 0.6				Watts W/°C
Operating and Storage Junction Temperature Range	T_J, T_{stg}	-55 to 150				°C
Maximum Lead Temp. for Soldering Purposes, 1/8" from case for 5 seconds	T_L	300				°C

- Notes:** (1) $T_J=25^\circ C$ to $150^\circ C$
 (2) Pulse test: Pulse width $\leq 300\mu s$, Duty Cycle $\leq 2\%$
 (3) Repetitive rating: Pulse width limited by max. junction temperature

ELECTRICAL CHARACTERISTICS (T_C=25 °C unless otherwise specified)

Characteristic	Symbol	Type	Min	Typ	Max	Units	Test Conditions
Drain-Source Breakdown Voltage	BV _{DSS}	IRFP430 IRFP432	500	—	—	V	V _{GS} =0V
		IRFP431 IRFP433	450	—	—	V	I _D =250μA
Gate Threshold Voltage	V _{GS(th)}	ALL	2.0	—	4.0	V	V _{DS} =V _{GS} , I _D =250μA
Gate-Source Leakage Forward	I _{GSS}	ALL	—	—	100	nA	V _{GS} =20V
Gate-Source Leakage Reverse	I _{GSS}	ALL	—	—	-100	nA	V _{GS} =-20V
Zero Gate Voltage Drain Current	I _{DSS}	ALL	—	—	250	μA	V _{DS} =Max. Rating, V _{GS} =0V
			—	—	1000	μA	V _{DS} =Max. Rating×0.8, V _{GS} =0V, T _C =125 °C
On-State Drain-Source Current (2)	I _{D(on)}	IRFP430 IRFP431	4.5	—	—	A	V _{DS} >I _{D(on)} ×R _{DS(on) max.} , V _{GS} =10V
		IRFP432 IRFP433	4.0	—	—	A	
Static Drain-Source On-State Resistance (2)	R _{DS(on)}	IRFP430 IRFP431	—	0.95	1.5	Ω	V _{GS} =10V, I _D =2.5A
		IRFP432 IRFP433	—	1.4	2.0	Ω	
Forward Transconductance (2)	g _{fs}	ALL	2.5	3.2	—	Ω	V _{DS} >I _{D(on)} ×R _{DS(on) max.} , I _D =2.5A
Input Capacitance	C _{iss}	ALL	—	720	800	pF	V _{GS} =0V, V _{DS} =25V, f=1.0MHz
Output Capacitance	C _{oss}	ALL	—	110	200	pF	
Reverse Transfer Capacitance	C _{rss}	ALL	—	50	60	pF	
Turn-On Delay Time	t _{d(on)}	ALL	—	—	30	ns	V _{DD} =0.5BV _{DSS} , I _D =2.5A, Z _O =15 Ω (MOSFET switching times are essentially independent of operating temperature.)
Rise Time	t _r	ALL	—	—	30	ns	
Turn-Off Delay Time	t _{d(off)}	ALL	—	—	55	ns	
Fall Time	t _f	ALL	—	—	30	ns	
Total Gate Charge (Gate-Source Plus Gate-Drain)	Q _g	ALL	—	22	30	nC	V _{GS} =10V, I _D =6.0A, V _{DS} =0.8 Max. Rating (Gate charge is essentially independent of operating temperature.)
Gate-Source Charge	Q _{gs}	ALL	—	4.2	—	nC	
Gate-Drain ("Miller") Charge	Q _{gd}	ALL	—	17.8	—	nC	

THERMAL RESISTANCE

Junction-to-Case	R _{thJC}	ALL	—	—	1.67	K/W	
Case-to-Sink	R _{thCS}	ALL	—	0.1	—	K/W	Mounting surface flat, smooth, and greased
Junction-to-Ambient	R _{thJA}	ALL	—	—	80	K/W	Free Air Operation

Notes: (1) T_J=25 °C to 150 °C

(2) Pulse test: Pulse width≤300μs, Duty Cycle≤2%

(3) Repetitive rating: Pulse width limited by max. junction temperature

SOURCE-DRAIN DIODE RATINGS AND CHARACTERISTICS

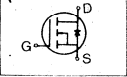
Characteristic	Symbol	Type	Min	Typ	Max	Units	Test Conditions
Continuous Source Current (Body Diode)	I _S	IRFP430	—	—	4.5	A	Modified MOSFET symbol showing the integral reverse P-N junction rectifier 
		IRFP431	—	—	4.5	A	
Pulse Source Current (Body Diode) (3)	I _{SM}	IRFP432	—	—	4.0	A	
		IRFP433	—	—	4.0	A	
Diode Forward Voltage (2)	V _{SD}	IRFP430	—	—	1.4	V	T _C =25°C, I _S =4.5A, V _{GS} =0V
		IRFP431	—	—	1.4	V	T _C =25°C, I _S =4.5A, V _{GS} =0V
Reverse Recovery Time	t _{rr}	IRFP432	—	—	1.3	V	T _C =25°C, I _S =4.0A, V _{GS} =0V
		IRFP433	—	—	1.3	V	T _C =25°C, I _S =4.0A, V _{GS} =0V
Reverse Recovery Time	t _{rr}	ALL	—	800	—	ns	T _J =150°C, I _F =4.5A, dI _F /dt=100A/μs

Notes: (1) T_J=25°C to 150°C (2) Pulse test: Pulse width ≤ 300μs, Duty Cycle ≤ 2%
 (3) Repetitive rating: Pulse width limited by max. junction temperature

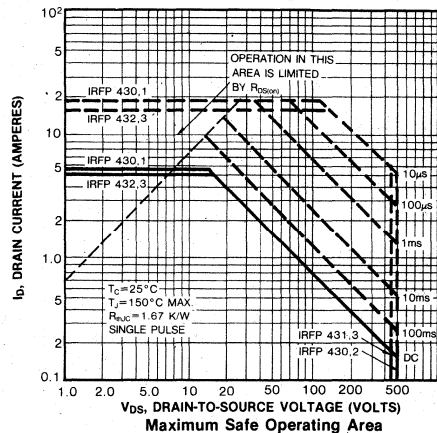
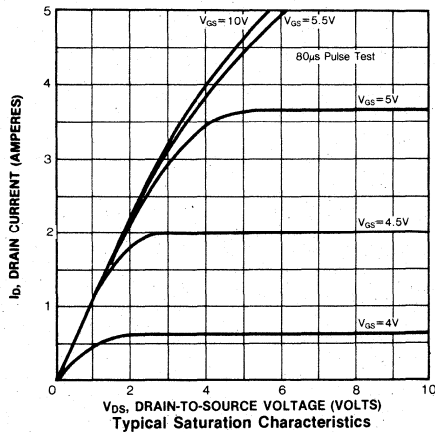
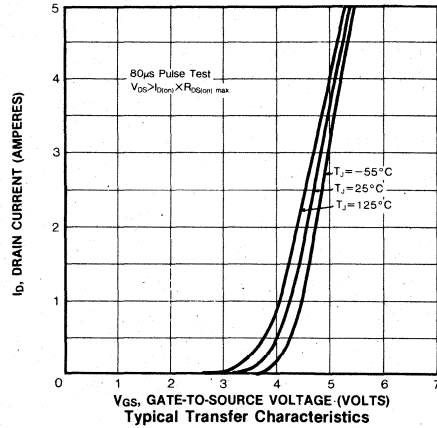
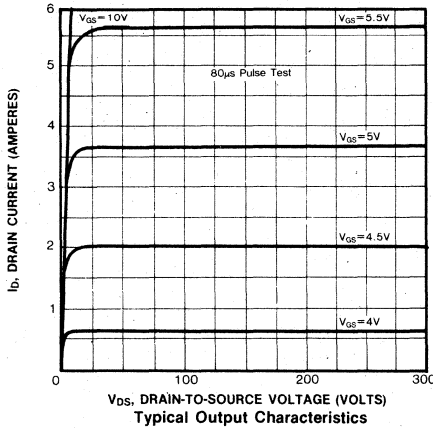

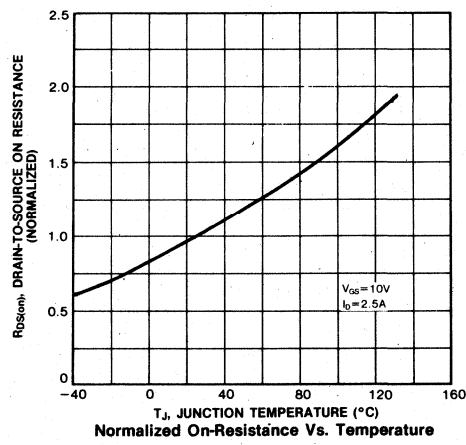
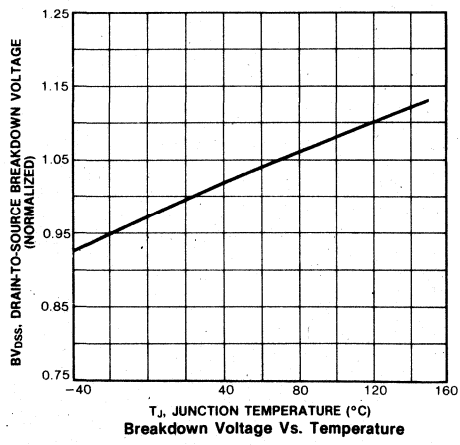
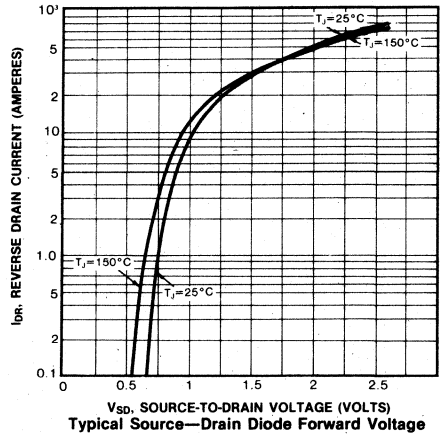
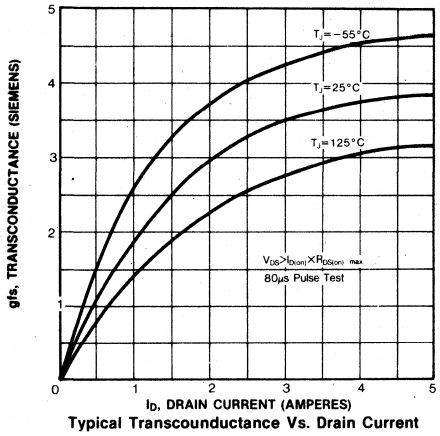
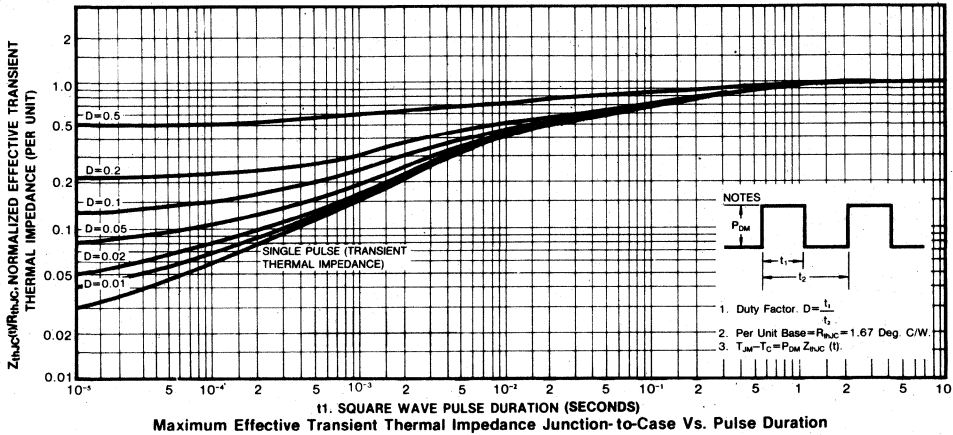

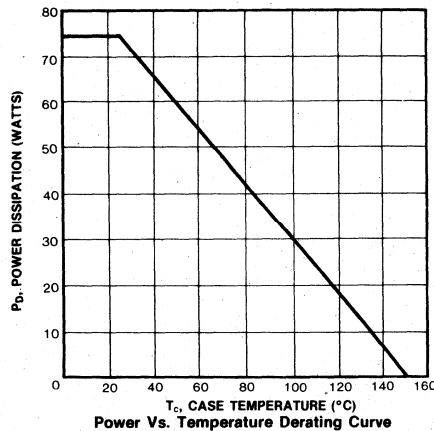
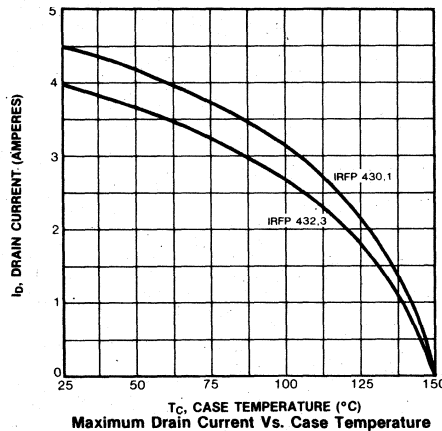
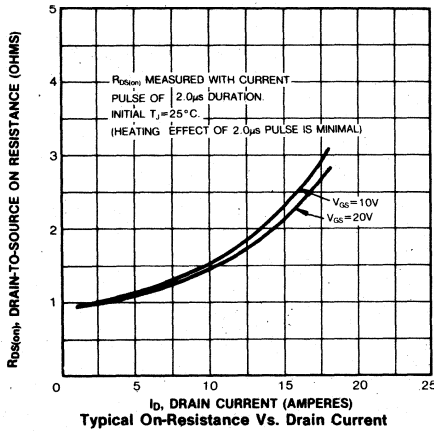
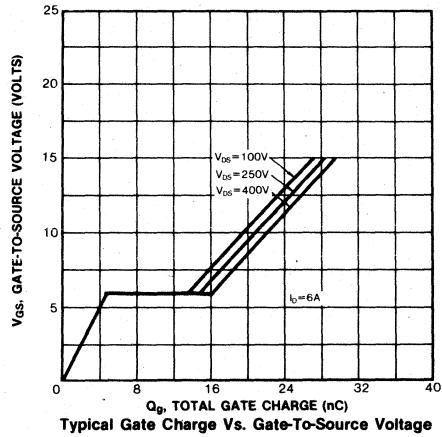
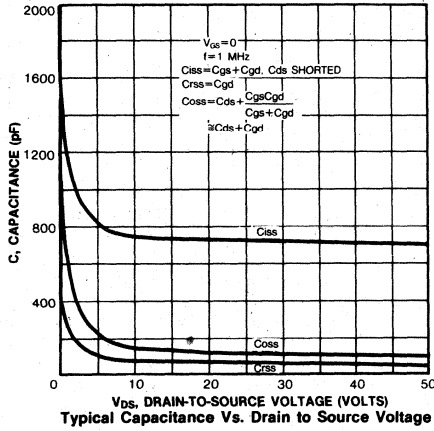

FEATURES

- Low $R_{DS(on)}$ at high voltage
- Improved inductive ruggedness
- Excellent high voltage stability
- Fast switching times
- Rugged polysilicon gate cell structure
- Low input capacitance
- Extended safe operating area
- Improved high temperature reliability
- TO-3P package

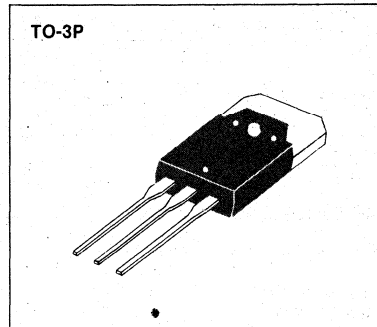

PRODUCT SUMMARY

Part Number	V_{DS}	$R_{DS(on)}$	I_D
IRFP440	500V	0.85Ω	8.0A
IRFP441	450V	0.85Ω	8.0A
IRFP442	500V	1.10Ω	7.0A
IRFP443	450V	1.10Ω	7.0A

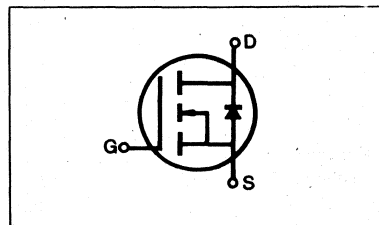

MAXIMUM RATINGS

Characteristic	Symbol	IRFP440	IRFP441	IRFP442	IRFP443	Unit
Drain-Source Voltage (1)	V_{DSS}	500	450	500	450	Vdc
Drain-Gate Voltage ($R_{GS}=1.0M\Omega$) (1)	V_{DGR}	500	450	500	450	Vdc
Gate-Source Voltage	V_{GS}	±20				Vdc
Continuous Drain Current $T_C=25^\circ C$	I_D	8.0	8.0	7.0	7.0	Adc
Continuous Drain Current $T_C=100^\circ C$	I_D	5.0	5.0	4.0	4.0	Adc
Drain Current—Pulsed (3)	I_{DM}	32	32	28	28	Adc
Gate Current—Pulsed	I_{GM}	±1.5				Adc
Total Power Dissipation @ $T_C=25^\circ C$ Derate above $25^\circ C$	P_D	125 1.0				Watts W/°C
Operating and Storage Junction Temperature Range	T_J, T_{stg}	-55 to 150				°C
Maximum Lead Temp. for Soldering Purposes, 1/8" from case for 5 seconds	T_L	300				°C

- Notes: (1) $T_J=25^\circ C$ to $150^\circ C$
 (2) Pulse test: Pulse width $\leq 300\mu s$, Duty Cycle $\leq 2\%$
 (3) Repetitive rating: Pulse width limited by max. junction temperature

ELECTRICAL CHARACTERISTICS (T_C=25°C unless otherwise specified)

Characteristic	Symbol	Type	Min	Typ	Max	Units	Test Conditions
Drain-Source Breakdown Voltage	BV _{DSS}	IRFP440 IRFP442	500	—	—	V	V _{GS} =0V
		IRFP441 IRFP443	450	—	—	V	I _D =250μA
		ALL	—	—	—	—	—
Gate Threshold Voltage	V _{GS(th)}	ALL	2.0	—	4.0	V	V _{DS} =V _{GS} , I _D =250μA
Gate-Source Leakage Forward	I _{GSS}	ALL	—	—	100	nA	V _{GS} =20V
Gate-Source Leakage Reverse	I _{GSS}	ALL	—	—	-100	nA	V _{GS} =-20V
Zero Gate Voltage Drain Current	I _{DSS}	ALL	—	—	250	μA	V _{DS} =Max. Rating, V _{GS} =0V
			—	—	1000	μA	V _{DS} =Max. Rating×0.8, V _{GS} =0V, T _C =125°C
On-State Drain-Source Current (2)	I _{D(on)}	IRFP440 IRFP441	8.0	—	—	A	V _{DS} >I _{D(on)} ×R _{DS(on) max.} , V _{GS} =10V
		IRFP442 IRFP443	7.0	—	—	A	
Static Drain-Source On-State Resistance (2)	R _{DS(on)}	IRFP440 IRFP441	—	0.6	0.85	Ω	V _{GS} =10V, I _D =4.0A
		IRFP442 IRFP443	—	1.0	1.1	Ω	
Forward Transconductance (2)	g _{fs}	ALL	4.0	6.5	—	∅	V _{DS} >I _{D(on)} ×R _{DS(on) max.} , I _D =4.0A
Input Capacitance	C _{iss}	ALL	—	1200	1600	pF	V _{GS} =0V, V _{DS} =25V, f=1.0MHz
Output Capacitance	C _{oss}	ALL	—	230	350	pF	
Reverse Transfer Capacitance	C _{rss}	ALL	—	65	150	pF	
Turn-On Delay Time	t _{d(on)}	ALL	—	—	35	ns	V _{DD} =0.5BV _{DSS} , I _D =4.0A, Z _O =4.7Ω (MOSFET switching times are essentially independent of operating temperature.)
Rise Time	t _r	ALL	—	—	15	ns	
Turn-Off Delay Time	t _{d(off)}	ALL	—	—	90	ns	
Fall Time	t _f	ALL	—	—	30	ns	
Total Gate Charge (Gate-Source Plus Gate-Drain)	Q _g	ALL	—	34	60	nC	V _{GS} =10V, I _D =10A, V _{DS} =0.8 Max. Rating (Gate charge is essentially independent of operating temperature.)
Gate-Source Charge	Q _{gs}	ALL	—	6.0	—	nC	
Gate-Drain ("Miller") Charge	Q _{gd}	ALL	—	28	—	nC	

THERMAL RESISTANCE

Junction-to-Case	R _{thJC}	ALL	—	—	1.0	K/W	
Case-to-Sink	R _{thCS}	ALL	—	0.1	—	K/W	Mounting surface flat, smooth, and greased
Junction-to-Ambient	R _{thJA}	ALL	—	—	80	K/W	Free Air Operation

- Notes:** (1) T_J=25°C to 150°C
 (2) Pulse test: Pulse width≤300μs, Duty Cycle≤2%
 (3) Repetitive rating: Pulse width limited by max. junction temperature

SOURCE-DRAIN DIODE RATINGS AND CHARACTERISTICS

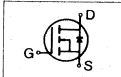
Characteristic	Symbol	Type	Min	Typ	Max	Units	Test Conditions
Continuous Source Current (Body Diode)	I_S	IRFP440 IRFP441	—	—	8.0	A	Modified MOSFET symbol showing the integral reverse P-N junction rectifier 
		IRFP442 IRFP443	—	—	7.0	A	
Pulse Source Current (Body Diode) (3)	I_{SM}	IRFP440 IRFP441	—	—	32	A	
		IRFP442 IRFP443	—	—	28	A	
Diode Forward Voltage (2)	V_{SD}	IRFP440 IRFP441	—	—	2.0	V	$T_C = 25^\circ\text{C}$, $I_S = 8.0\text{A}$, $V_{GS} = 0\text{V}$
		IRFP442 IRFP443	—	—	1.9	V	$T_C = 25^\circ\text{C}$, $I_S = 7.0\text{A}$, $V_{GS} = 0\text{V}$
Reverse Recovery Time	t_{rr}	ALL	—	1100	—	ns	$T_J = 150^\circ\text{C}$, $I_F = 8.0\text{A}$, $dI_F/dt = 100\text{A}/\mu\text{s}$

Notes: (1) $T_J = 25^\circ\text{C}$ to 150°C (2) Pulse test: Pulse width $\leq 300\mu\text{s}$, Duty Cycle $\leq 2\%$
 (3) Repetitive rating: Pulse width limited by max. junction temperature

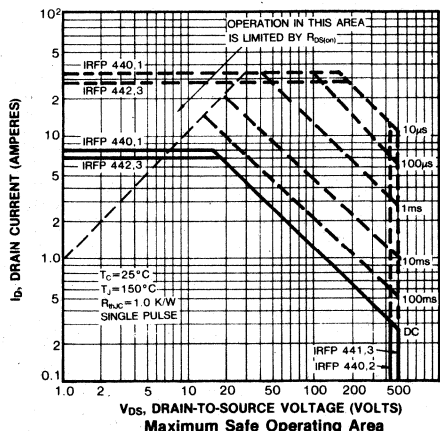
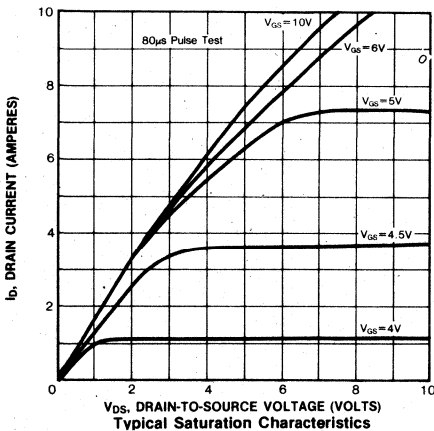
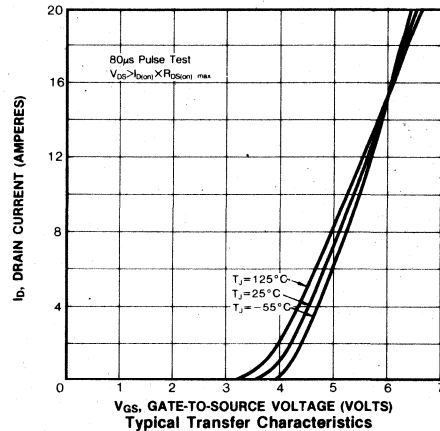
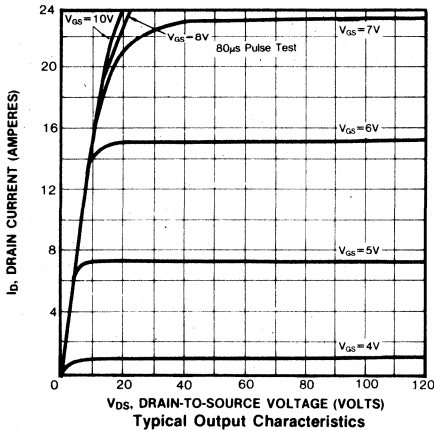

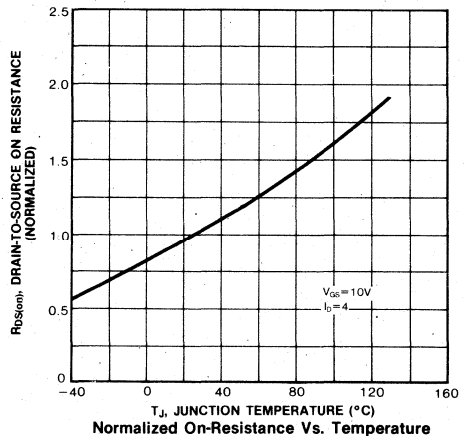
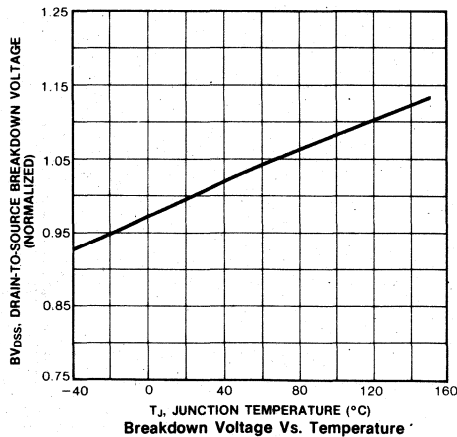
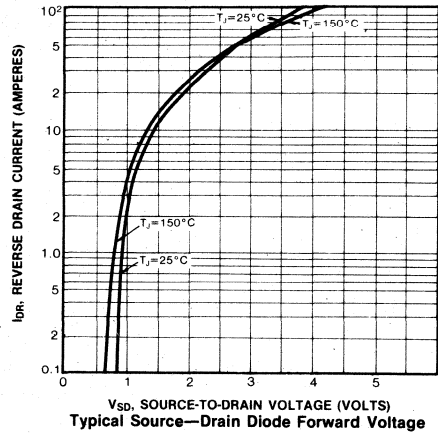
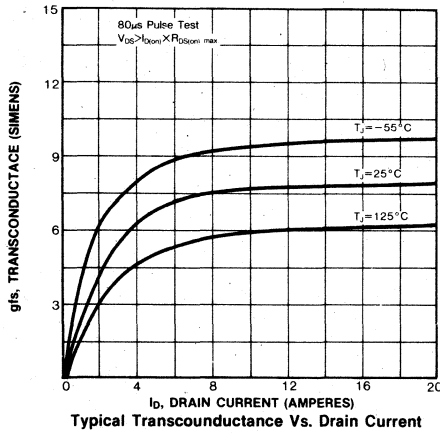
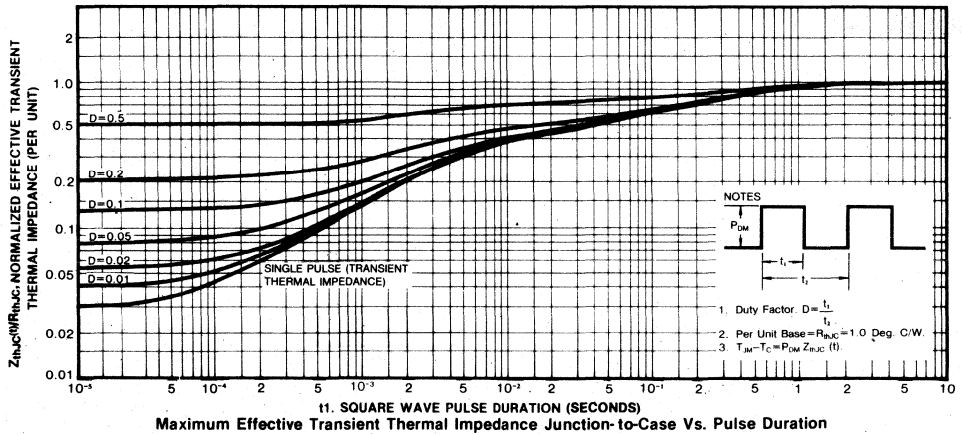

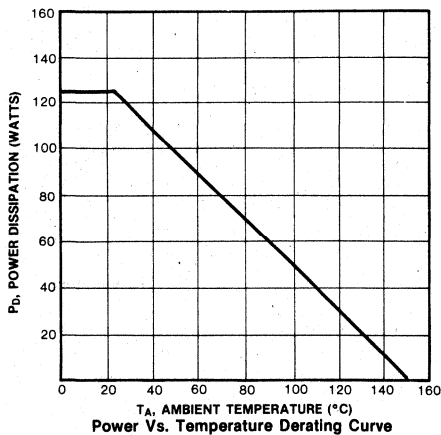
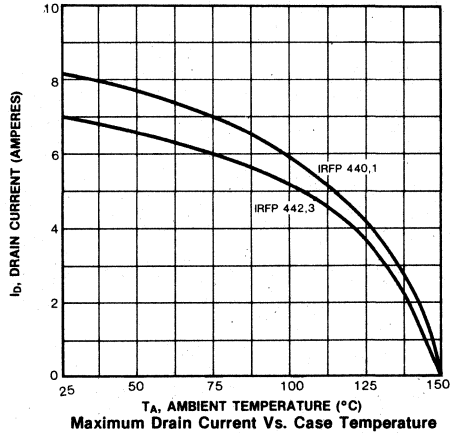
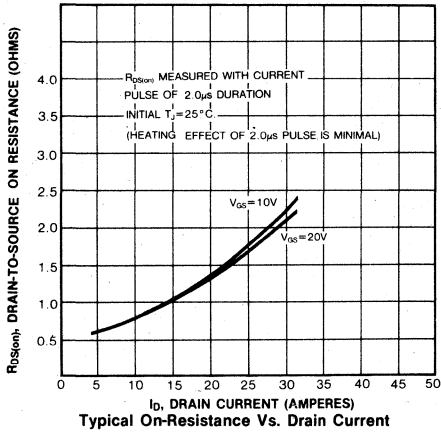
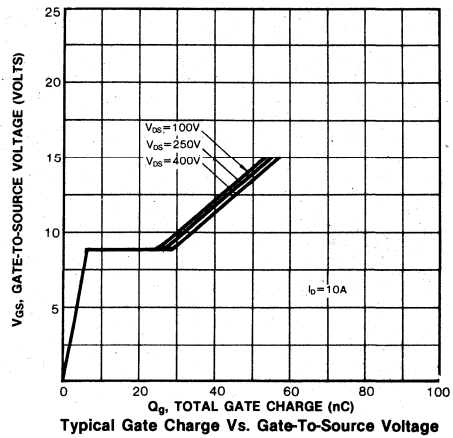
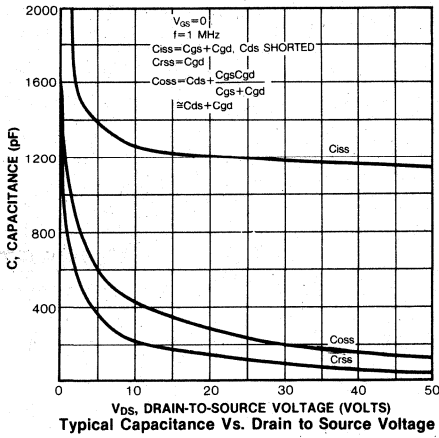

FEATURES

- Low $R_{DS(on)}$ at high voltage
- Improved inductive ruggedness
- Excellent high voltage stability
- Fast switching times
- Rugged polysilicon gate cell structure
- Low input capacitance
- Extended safe operating area
- Improved high temperature reliability
- TO-3P package

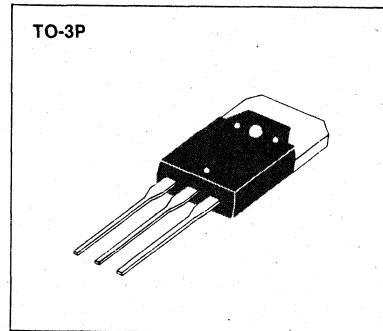

PRODUCT SUMMARY

Part Number	V_{DS}	$R_{DS(on)}$	I_D
IRFP450	500V	0.4 Ω	13A
IRFP451	450V	0.4 Ω	13A
IRFP452	500V	0.5 Ω	12A
IRFP453	450V	0.5 Ω	12A

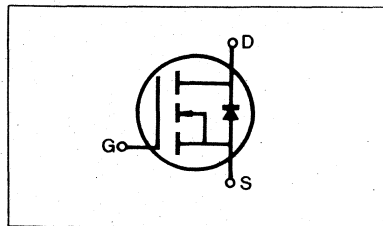

4

MAXIMUM RATINGS

Characteristic	Symbol	IRFP450	IRFP451	IRFP452	IRFP453	Unit
Drain-Source Voltage (1)	V_{DSS}	500	450	500	450	Vdc
Drain-Gate Voltage ($R_{GS}=1.0M\Omega$) (1)	V_{DGR}	500	450	500	450	Vdc
Gate-Source Voltage	V_{GS}	± 20				Vdc
Continuous Drain Current $T_C=25^\circ C$	I_D	13	13	12	12	Adc
Continuous Drain Current $T_C=100^\circ C$	I_D	8.0	8.0	7.0	7.0	Adc
Drain Current—Pulsed (3)	I_{DM}	52	52	48	48	Adc
Gate Current—Pulsed	I_{GM}	± 1.5				Adc
Total Power Dissipation @ $T_C=25^\circ C$ Derate above $25^\circ C$	P_D	150 1.2				Watts W/ $^\circ C$
Operating and Storage Junction Temperature Range	T_J, T_{stg}	-55 to 150				$^\circ C$
Maximum Lead Temp. for Soldering Purposes, 1/8" from case for 5 seconds	T_L	300				$^\circ C$

- Notes:** (1) $T_J=25^\circ C$ to $150^\circ C$
 (2) Pulse test: Pulse width $\leq 300\mu s$, Duty Cycle $\leq 2\%$
 (3) Repetitive rating: Pulse width limited by max. junction temperature

ELECTRICAL CHARACTERISTICS (T_C=25°C unless otherwise specified)

Characteristic	Symbol	Type	Min	Typ	Max	Units	Test Conditions
Drain-Source Breakdown Voltage	BV _{DSS}	IRFP450 IRFP452	500	—	—	V	V _{GS} =0V
		IRFP451 IRFP453	450	—	—	V	I _D =250μA
Gate Threshold Voltage	V _{GS(th)}	ALL	2.0	—	4.0	V	V _{DS} =V _{GS} , I _D =250μA
Gate-Source Leakage Forward	I _{GSS}	ALL	—	—	100	nA	V _{GS} =20V
Gate-Source Leakage Reverse	I _{GSS}	ALL	—	—	-100	nA	V _{GS} =-20V
Zero Gate Voltage Drain Current	I _{DSS}	ALL	—	—	250	μA	V _{DS} =Max. Rating, V _{GS} =0V
			—	—	1000	μA	V _{DS} =Max. Rating×0.8, V _{GS} =0V, T _C =125°C
On-State Drain-Source Current (2)	I _{D(on)}	IRFP450 IRFP451	13	—	—	A	V _{DS} >I _{D(on)} ×R _{DS(on) max.} , V _{GS} =10V
		IRFP452 IRFP453	12	—	—	A	
		—	—	—	—	—	
Static Drain-Source On-State Resistance (2)	R _{DS(on)}	IRFP450 IRFP451	—	0.38	0.4	Ω	V _{GS} =10V, I _D =7.0A
		IRFP452 IRFP453	—	0.4	0.5	Ω	
		—	—	—	—	—	
Forward Transconductance (2)	g _{fs}	ALL	6.0	10.8	—	S	V _{DS} >I _{D(on)} ×R _{DS(on) max.} , I _D =7.0A
Input Capacitance	C _{iss}	ALL	—	2850	3000	pF	V _{GS} =0V, V _{DS} =25V, f=1.0MHz
Output Capacitance	C _{oss}	ALL	—	350	600	pF	
Reverse Transfer Capacitance	C _{rss}	ALL	—	150	200	pF	
Turn-On Delay Time	t _{d(on)}	ALL	—	—	35	ns	V _{DD} =0.5BV _{DSS} , I _D =7.0A, Z _O =4.7 Ω (MOSFET switching times are essentially independent of operating temperature.)
Rise Time	t _r	ALL	—	—	50	ns	
Turn-Off Delay Time	t _{d(off)}	ALL	—	—	150	ns	
Fall Time	t _f	ALL	—	—	70	ns	
Total Gate Charge (Gate-Source Plus Gate-Drain)	Q _g	ALL	—	77	120	nC	
Gate-Source Charge	Q _{gs}	ALL	—	11	—	nC	V _{GS} =10V, I _D =16A, V _{DS} =0.8 Max. Rating (Gate charge is essentially independent of operating temperature.)
Gate-Drain ("Miller") Charge	Q _{gd}	ALL	—	66	—	nC	

THERMAL RESISTANCE

Junction-to-Case	R _{thJC}	ALL	—	—	0.83	K/W	
Case-to-Sink	R _{thCS}	ALL	—	0.1	—	K/W	Mounting surface flat, smooth, and greased
Junction-to-Ambient	R _{thJA}	ALL	—	—	80	K/W	Free Air Operation

Notes: (1) T_J=25°C to 150°C

(2) Pulse test: Pulse width≤300μs, Duty Cycle≤2%

(3) Repetitive rating: Pulse width limited by max. junction temperature

SOURCE-DRAIN DIODE RATINGS AND CHARACTERISTICS

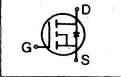
Characteristic	Symbol	Type	Min	Typ	Max	Units	Test Conditions
Continuous Source Current (Body Diode)	I_S	IRFP450	—	—	13	A	Modified MOSFET symbol showing the integral reverse P-N junction rectifier 
		IRFP452	—	—	12	A	
		IRFP453	—	—	12	A	
Pulse Source Current (Body Diode) (3)	I_{SM}	IRFP450	—	—	52	A	
		IRFP452	—	—	48	A	
		IRFP453	—	—	48	A	
Diode Forward Voltage (2)	V_{SD}	IRFP450	—	—	1.4	V	$T_C=25^\circ\text{C}$, $I_S=13\text{A}$, $V_{GS}=0\text{V}$
		IRFP451	—	—	1.4	V	
		IRFP452	—	—	1.3	V	$T_C=25^\circ\text{C}$, $I_S=12\text{A}$, $V_{GS}=0\text{V}$
Reverse Recovery Time	t_{rr}	ALL	—	1300	—	ns	$T_J=150^\circ\text{C}$, $I_F=13\text{A}$, $di/dt=100\text{A}/\mu\text{s}$

Notes: (1) $T_J=25^\circ\text{C}$ to 150°C (2) Pulse test: Pulse width $\leq 300\mu\text{s}$, Duty Cycle $\leq 2\%$
 (3) Repetitive rating: Pulse width limited by max. junction temperature

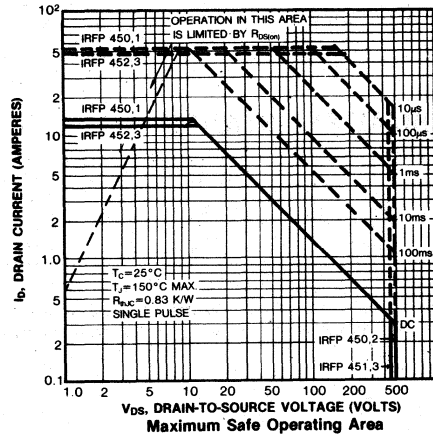
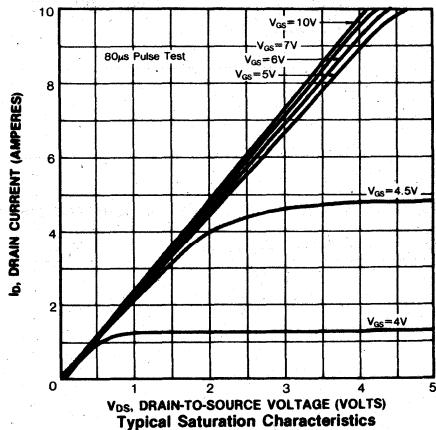
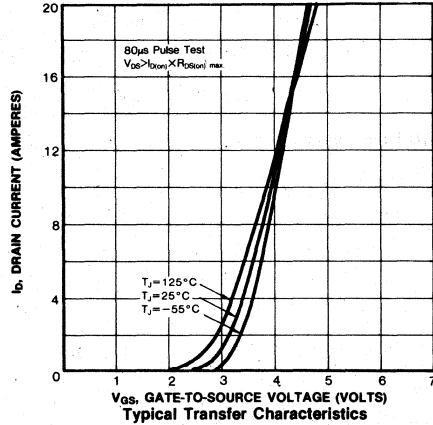
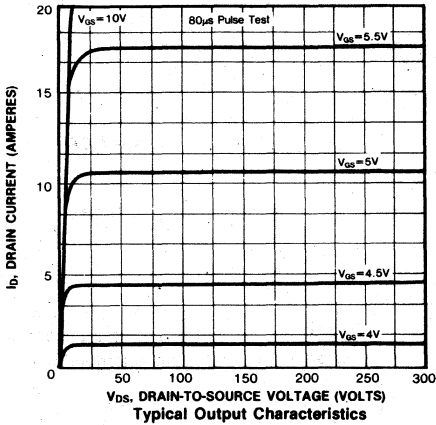

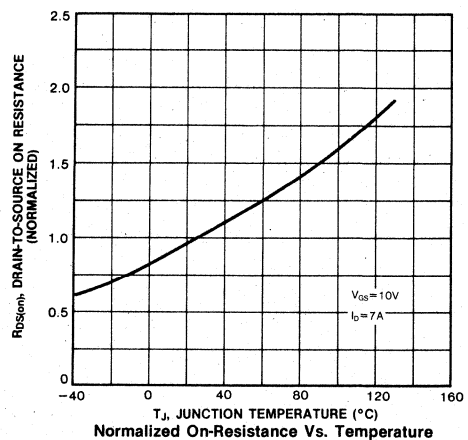
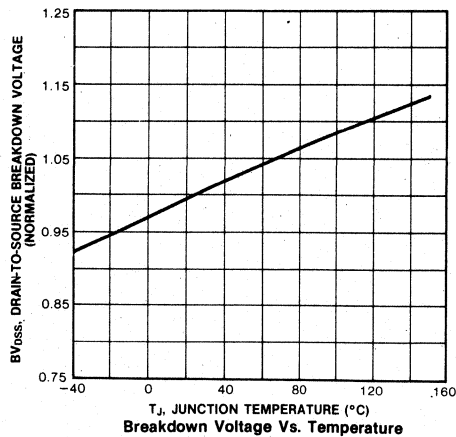
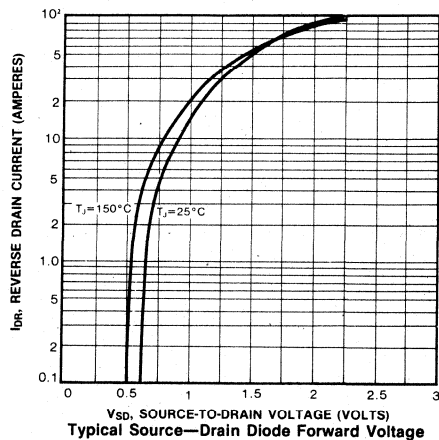
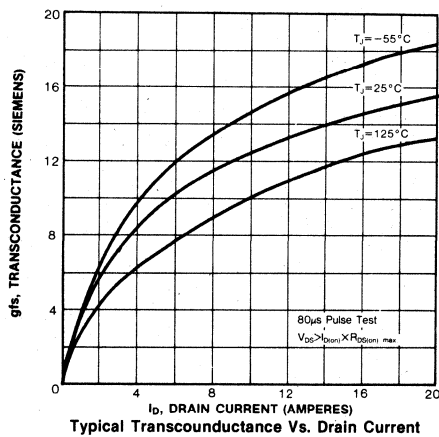
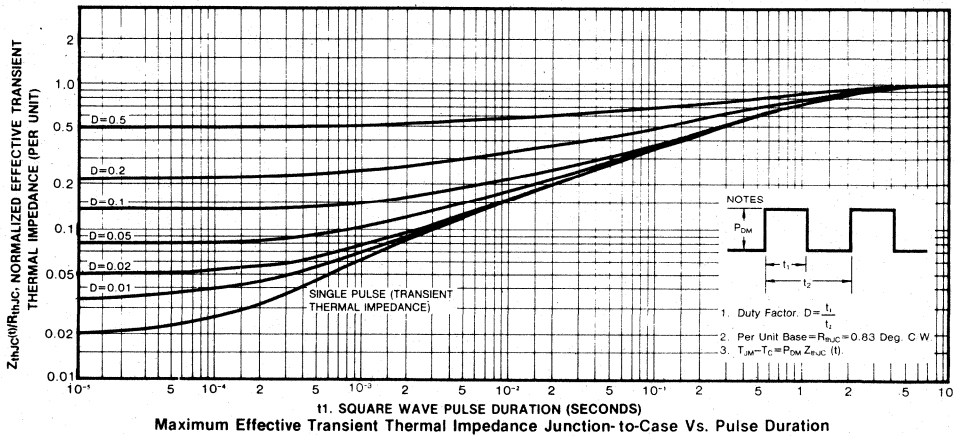

IRFP450/451/452/453

N-CHANNEL POWER MOSFETS

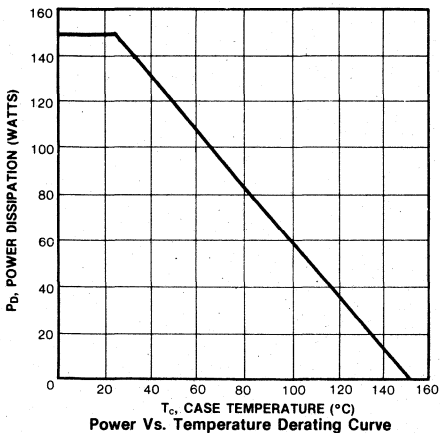
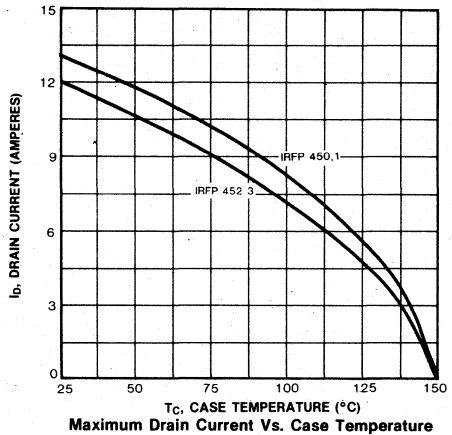
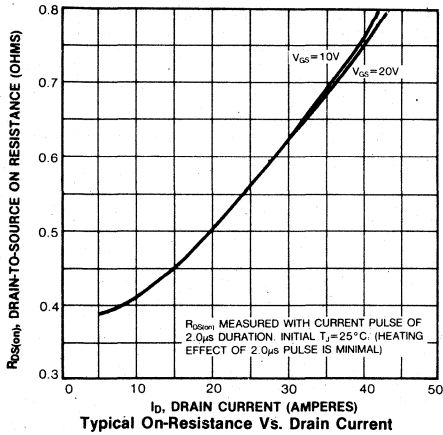
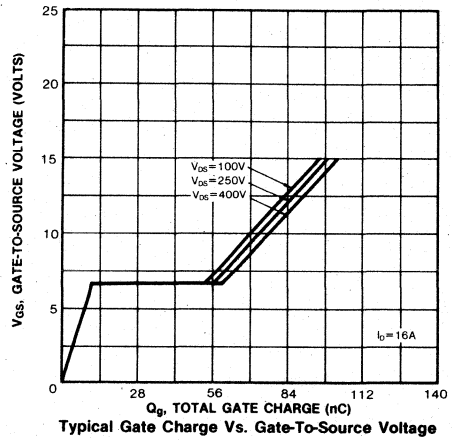
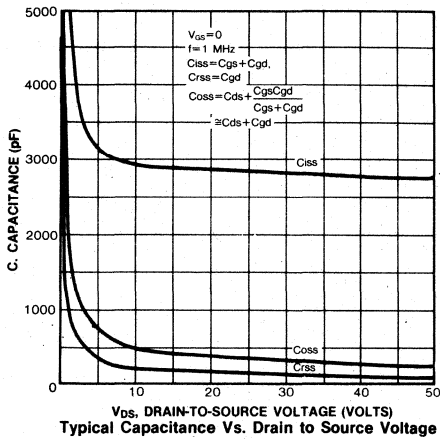

4

FEATURES

- Low $R_{DS(on)}$
- Improved inductive ruggedness
- Fast switching times
- Rugged polysilicon gate cell structure
- Low input capacitance
- Extended safe operating area
- Improved high temperature reliability
- TO-220 package

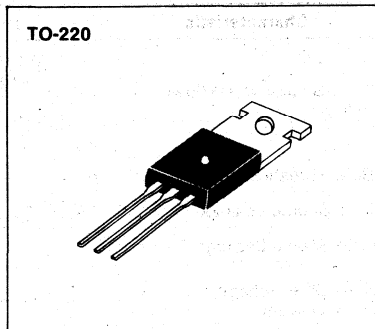

PRODUCT SUMMARY

Part Number	V_{DS}	$R_{DS(on)}$	I_D
IRF510	100V	0.6 Ω	4.0A
IRF511	60V	0.6 Ω	4.0A
IRF512	100V	0.8 Ω	3.5A
IRF513	60V	0.8 Ω	3.5A

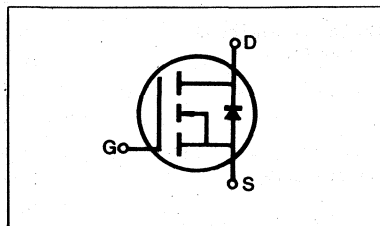

MAXIMUM RATINGS

Characteristic	Symbol	IRF510	IRF511	IRF512	IRF513	Unit
Drain-Source Voltage (1)	V_{DS}	100	60	100	60	Vdc
Drain-Gate Voltage ($R_{GS}=1.0M\Omega$) (1)	V_{DGR}	100	60	100	60	Vdc
Gate-Source Voltage	V_{GS}	± 20				Vdc
Continuous Drain Current $T_C=25^\circ C$	I_D	4.0	4.0	3.5	3.5	Adc
Continuous Drain Current $T_C=100^\circ C$	I_D	2.5	2.5	2.0	2.0	Adc
Drain Current—Pulsed (3)	I_{DM}	16	16	14	14	Adc
Gate Current—Pulsed	I_{GM}	± 1.5				Adc
Total Power Dissipation @ $T_C=25^\circ C$ Derate above $25^\circ C$	P_D	20 0.16				Watts W/ $^\circ C$
Operating and Storage Junction Temperature Range	T_J, T_{stg}	-55 to 150				$^\circ C$
Maximum Lead Temp. for Soldering Purposes, 1/8" from case for 5 seconds	T_L	300				$^\circ C$

- Notes: (1) $T_J=25^\circ C$ to $150^\circ C$
 (2) Pulse test: Pulse width $\leq 300\mu s$, Duty Cycle $\leq 2\%$
 (3) Repetitive rating: Pulse width limited by max. junction temperature

ELECTRICAL CHARACTERISTICS (T_C=25°C unless otherwise specified)

Characteristic	Symbol	Type	Min	Typ	Max	Units	Test Conditions
Drain-Source Breakdown Voltage	BV _{DSS}	IRF510 IRF512	100	—	—	V	V _{GS} =0V
		IRF511 IRF513	60	—	—	V	I _D =250μA
Gate Threshold Voltage	V _{GS(th)}	ALL	2.0	—	4.0	V	V _{DS} =V _{GS} , I _D =250μA
Gate-Source Leakage Forward	I _{GSS}	ALL	—	—	100	nA	V _{GS} =20V
Gate-Source Leakage Reverse	I _{GSS}	ALL	—	—	-100	nA	V _{GS} =-20V
Zero Gate Voltage Drain Current	I _{DSS}	ALL	—	—	250	μA	V _{DS} =Max. Rating, V _{GS} =0V
			—	—	1000	μA	V _{DS} =Max. Rating×0.8, V _{GS} =0V, T _C =125°C
On-State Drain-Source Current (2)	I _{D(on)}	IRF510 IRF511	4.0	—	—	A	V _{DS} >I _{D(on)} ×R _{DS(on)} max., V _{GS} =10V
		IRF512 IRF513	3.5	—	—	A	
Static Drain-Source On-State Resistance (2)	R _{DS(on)}	IRF510 IRF511	—	0.4	0.6	Ω	V _{GS} =10V, I _D =2.0A
		IRF512 IRF513	—	0.6	0.8	Ω	
Forward Transconductance (2)	g _{fs}	ALL	1.0	1.6	—	S	V _{DS} >I _{D(on)} ×R _{DS(on)} max., I _D =2.0A
Input Capacitance	C _{iss}	ALL	—	145	150	pF	V _{GS} =0V, V _{DS} =25V, f=1.0MHz
Output Capacitance	C _{oss}	ALL	—	90	100	pF	
Reverse Transfer Capacitance	C _{rss}	ALL	—	20	25	pF	
Turn-On Delay Time	t _{d(on)}	ALL	—	—	20	ns	V _{DD} =0.5BV _{DSS} , I _D =2.0A, Z _O =50Ω (MOSFET switching times are essentially independent of operating temperature)
Rise Time	t _r	ALL	—	—	25	ns	
Turn-Off Delay Time	t _{d(off)}	ALL	—	—	25	ns	
Fall Time	t _f	ALL	—	—	20	ns	
Total Gate Charge (Gate-Source Plus Gate-Drain)	Q _g	ALL	—	4.7	7.5	nC	V _{GS} =10V, I _D =5.0A, V _{DS} =0.8 Max. Rating
Gate-Source Charge	Q _{gs}	ALL	—	1.9	—	nC	(Gate charge is essentially independent of operating temperature)
Gate-Drain ("Miller") Charge	Q _{gd}	ALL	—	2.8	—	nC	

4

THERMAL RESISTANCE

Junction-to-Case	R _{thJC}	ALL	—	—	6.4	K/W	
Case-to-Sink	R _{thCS}	ALL	—	1.0	—	K/W	Mounting surface flat, smooth, and greased
Junction-to-Ambient	R _{thJA}	ALL	—	—	80	K/W	Free Air Operation

- Notes:** (1) T_J=25°C to 150°C
 (2) Pulse test: Pulse width<300μs, Duty Cycle<2%
 (3) Repetitive rating: Pulse width limited by max. junction temperature

SOURCE-DRAIN DIODE RATINGS AND CHARACTERISTICS

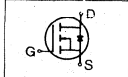
Characteristic	Symbol	Type	Min	Typ	Max	Units	Test Conditions
Continuous Source Current (Body Diode)	I _S	IRF510	—	—	4.0	A	Modified MOSFET symbol showing the integral reverse P-N junction rectifier 
		IRF511	—	—	4.0	A	
		IRF512	—	—	3.5	A	
		IRF513	—	—	3.5	A	
Pulse Source Current (Body Diode) (3)	I _{SM}	IRF510	—	—	16	A	
		IRF511	—	—	16	A	
		IRF512	—	—	14	A	
		IRF513	—	—	14	A	
Diode Forward Voltage (2)	V _{SD}	IRF510	—	—	2.5	V	T _C =25°C, I _S =4.0A, V _{GS} =0V
		IRF511	—	—	2.5	V	T _C =25°C, I _S =4.0A, V _{GS} =0V
		IRF512	—	—	2.0	V	T _C =25°C, I _S =3.5A, V _{GS} =0V
		IRF513	—	—	2.0	V	T _C =25°C, I _S =3.5A, V _{GS} =0V
Reverse Recovery Time	t _{rr}	ALL	—	230	—	ns	T _J =150°C, I _F =13A, dI _F /dt=100A/μs

Notes: (1) T_J=25°C to 150°C (2) Pulse test: Pulse width ≤ 300μs, Duty Cycle ≤ 2%
 (3) Repetitive rating: Pulse width limited by max. junction temperature

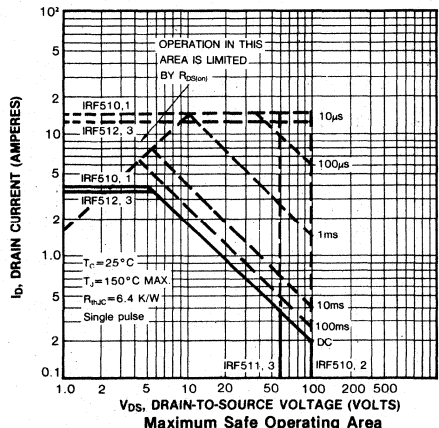
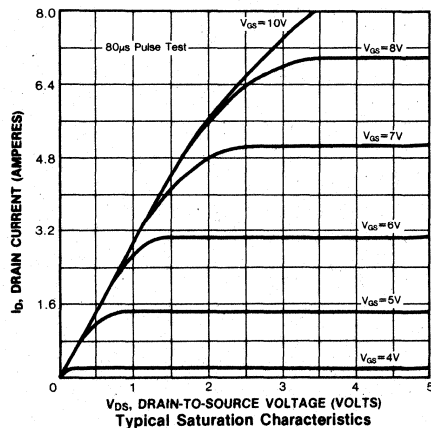
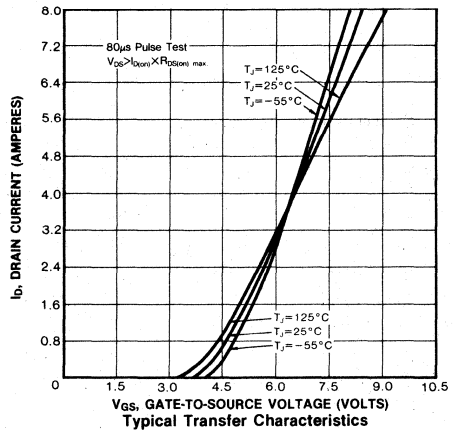
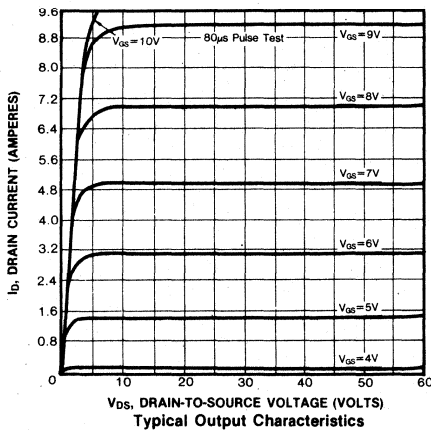

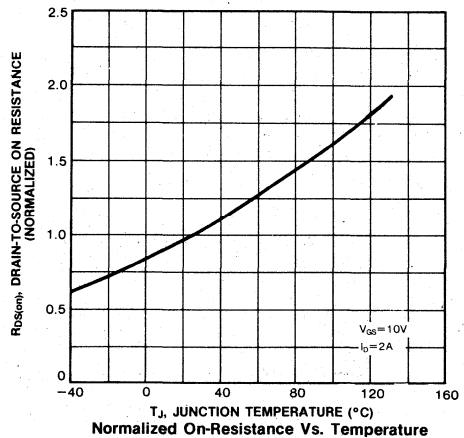
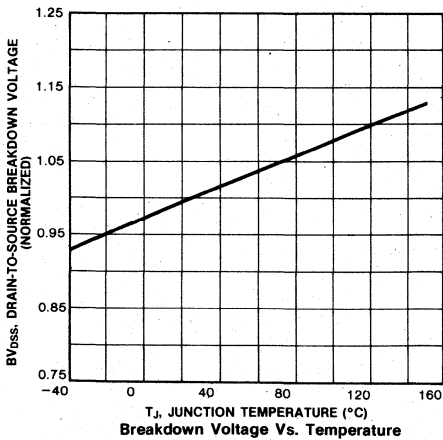
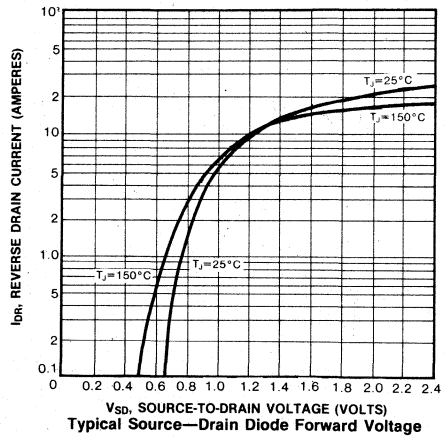
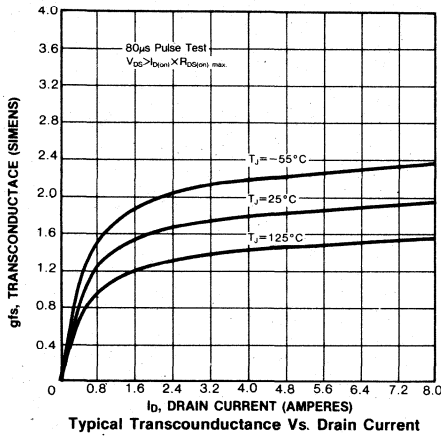
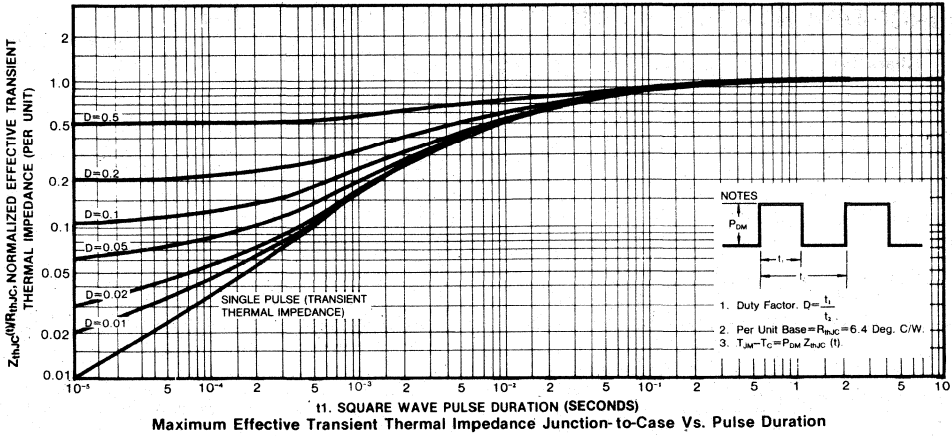

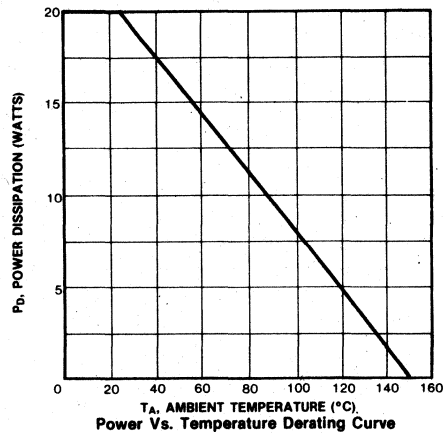
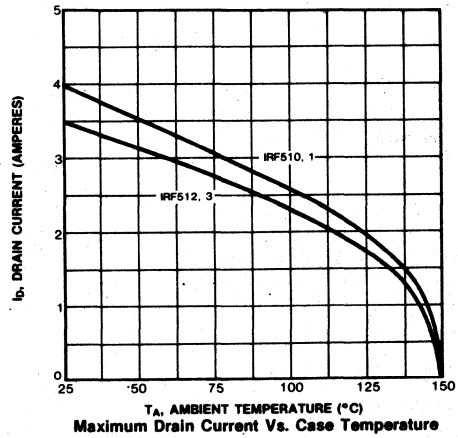
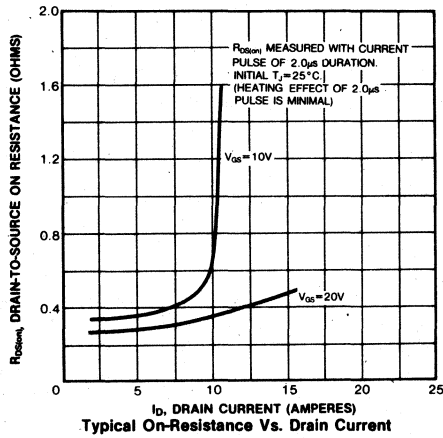
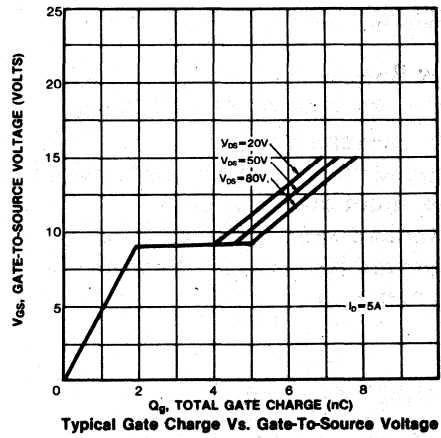
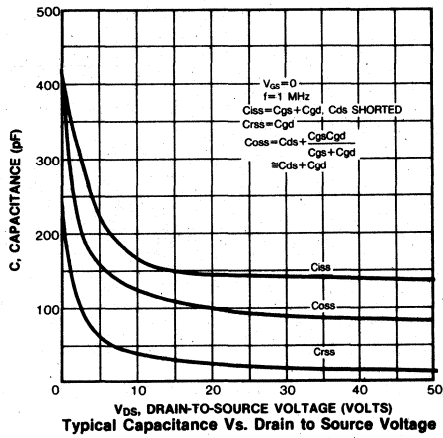

FEATURES

- Low $R_{DS(on)}$
- Improved inductive ruggedness
- Fast switching times
- Rugged polysilicon gate cell structure
- Low input capacitance
- Extended safe operating area
- Improved high temperature reliability
- TO-220 package

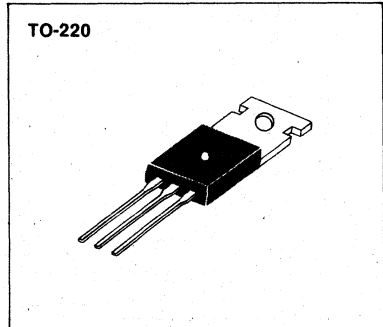

PRODUCT SUMMARY

Part Number	V_{DS}	$R_{DS(on)}$	I_D
IRF520	100V	0.30 Ω	8.0A
IRF521	60V	0.30 Ω	8.0A
IRF522	100V	0.40 Ω	7.0A
IRF523	60V	0.40 Ω	7.0A

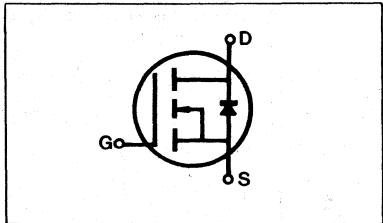

MAXIMUM RATINGS

Characteristic	Symbol	IRF520	IRF521	IRF522	IRF523	Unit
Drain-Source Voltage (1)	V_{DSS}	100	60	100	60	Vdc
Drain-Gate Voltage ($R_{GS}=1.0M\Omega$) (1)	V_{DGR}	100	60	100	60	Vdc
Gate-Source Voltage	V_{GS}	± 20				Vdc
Continuous Drain Current $T_C=25^\circ C$	I_D	8.0	8.0	7.0	7.0	Adc
Continuous Drain Current $T_C=100^\circ C$	I_D	5.0	5.0	4.0	4.0	Adc
Drain Current—Pulsed (3)	I_{DM}	32	32	28	28	Adc
Gate Current—Pulsed	I_{GM}	± 1.5				Adc
Total Power Dissipation @ $T_C=25^\circ C$ Derate above $25^\circ C$	P_D	40 0.32				Watts W/ $^\circ C$
Operating and Storage Junction Temperature Range	T_J, T_{stg}	-55 to 150				$^\circ C$
Maximum Lead Temp. for Soldering Purposes, 1/8" from case for 5 seconds	T_L	300				$^\circ C$

Notes: (1) $T_J=25^\circ C$ to $150^\circ C$

(2) Pulse test: Pulse width $\leq 300\mu s$, Duty Cycle $\leq 2\%$

(3) Repetitive rating: Pulse width limited by max. junction temperature

ELECTRICAL CHARACTERISTICS (T_C=25°C unless otherwise specified)

Characteristic	Symbol	Type	Min	Typ	Max	Units	Test Conditions
Drain-Source Breakdown Voltage	BV _{DSS}	IRF520 IRF522	100	—	—	V	V _{GS} =0V
		IRF521 IRF523	60	—	—	V	I _D =250μA
Gate Threshold Voltage	V _{GS(th)}	ALL	2.0	—	4.0	V	V _{DS} =V _{GS} , I _D =250μA
Gate-Source Leakage Forward	I _{GSS}	ALL	—	—	100	nA	V _{GS} =20V
Gate-Source Leakage Reverse	I _{GSS}	ALL	—	—	-100	nA	V _{GS} =-20V
Zero Gate Voltage Drain Current	I _{DSS}	ALL	—	—	250	μA	V _{DS} =Max. Rating, V _{GS} =0V
			—	—	1000	μA	V _{DS} =Max. Rating×0.8, V _{GS} =0V, T _C =125°C
On-State Drain-Source Current (2)	I _{D(on)}	IRF520 IRF521	8.0	—	—	A	V _{DS} >I _{D(on)} ×R _{DS(on)} max., V _{GS} =10V
		IRF522 IRF523	7.0	—	—	A	
Static Drain-Source On-State Resistance (2)	R _{DS(on)}	IRF520 IRF521	—	0.23	0.30	Ω	V _{GS} =10V, I _D =4.0A
		IRF522 IRF523	—	0.30	0.40	Ω	
Forward Transconductance (2)	g _{fs}	ALL	1.5	3.1	—	S	V _{DS} >I _{D(on)} ×R _{DS(on)} max., I _D =4.0A
Input Capacitance	C _{iss}	ALL	—	460	600	pF	V _{GS} =0V, V _{DS} =25V, f=1.0MHz
Output Capacitance	C _{oss}	ALL	—	220	400	pF	
Reverse Transfer Capacitance	C _{rss}	ALL	—	70	100	pF	
Turn-On Delay Time	t _{d(on)}	ALL	—	—	40	ns	V _{DD} =0.5BV _{DSS} , I _D =4.0A, Z _O =50Ω (MOSFET switching times are essentially independent of operating temperature.)
Rise Time	t _r	ALL	—	—	70	ns	
Turn-Off Delay Time	t _{d(off)}	ALL	—	—	100	ns	
Fall Time	t _f	ALL	—	—	70	ns	
Total Gate Charge (Gate-Source Plus Gate-Drain)	Q _g	ALL	—	9.8	15	nC	V _{GS} =10V, I _D =10A, V _{DS} =0.8 Max. Rating (Gate charge is essentially independent of operating temperature.)
Gate-Source Charge	Q _{gs}	ALL	—	3.5	—	nC	
Gate-Drain ("Miller") Charge	Q _{gd}	ALL	—	6.3	—	nC	

THERMAL RESISTANCE

Junction-to-Case	R _{thJC}	ALL	—	—	3.12	K/W	
Case-to-Sink	R _{thCS}	ALL	—	1.0	—	K/W	Mounting surface flat, smooth, and greased
Junction-to-Ambient	R _{thJA}	ALL	—	—	80	K/W	Free Air Operation

- Notes:** (1) T_J=25°C to 150°C
(2) Pulse test: Pulse width ≤ 300μs, Duty Cycle ≤ 2%
(3) Repetitive rating: Pulse width limited by max. junction temperature

SOURCE-DRAIN DIODE RATINGS AND CHARACTERISTICS

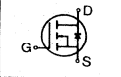
Characteristic	Symbol	Type	Min	Typ	Max	Units	Test Conditions
Continuous Source Current (Body Diode)	I_S	IRF520	—	—	8.0	A	Modified MOSFET symbol showing the integral reverse P-N junction rectifier 
		IRF521	—	—	8.0	A	
Pulse Source Current (Body Diode) (3)	I_{SM}	IRF520	—	—	32	A	
		IRF521	—	—	32	A	
Diode Forward Voltage (2)	V_{SD}	IRF520	—	—	2.5	V	$T_C=25^\circ\text{C}$, $I_S=8.0\text{A}$, $V_{GS}=0\text{V}$
		IRF521	—	—	2.5	V	$T_C=25^\circ\text{C}$, $I_S=8.0\text{A}$, $V_{GS}=0\text{V}$
Diode Forward Voltage (2)	V_{SD}	IRF522	—	—	2.3	V	$T_C=25^\circ\text{C}$, $I_S=7.0\text{A}$, $V_{GS}=0\text{V}$
		IRF523	—	—	2.3	V	$T_C=25^\circ\text{C}$, $I_S=7.0\text{A}$, $V_{GS}=0\text{V}$
Reverse Recovery Time	t_{rr}	ALL	—	280	—	ns	$T_J=150^\circ\text{C}$, $I_F=8.0\text{A}$, $dI_F/dt=100\text{A}/\mu\text{s}$

Notes: (1) $T_J=25^\circ\text{C}$ to 150°C (2) Pulse test: Pulse width $\leq 300\mu\text{s}$, Duty Cycle $\leq 2\%$
 (3) Repetitive rating: Pulse width limited by max. junction temperature

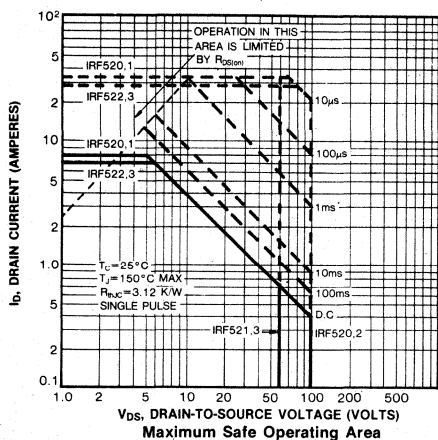
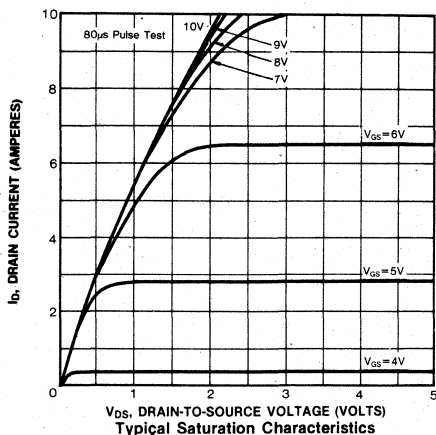
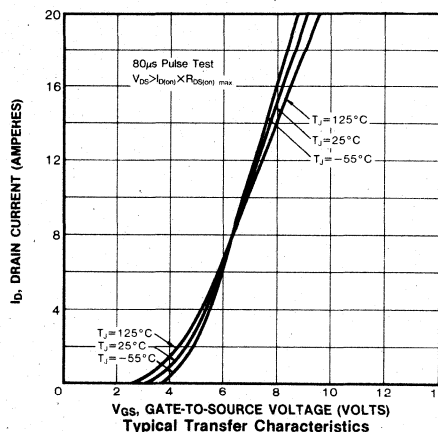
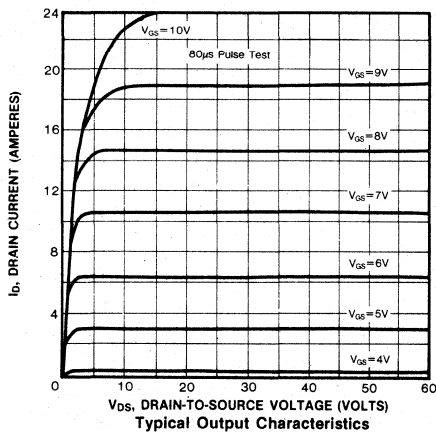

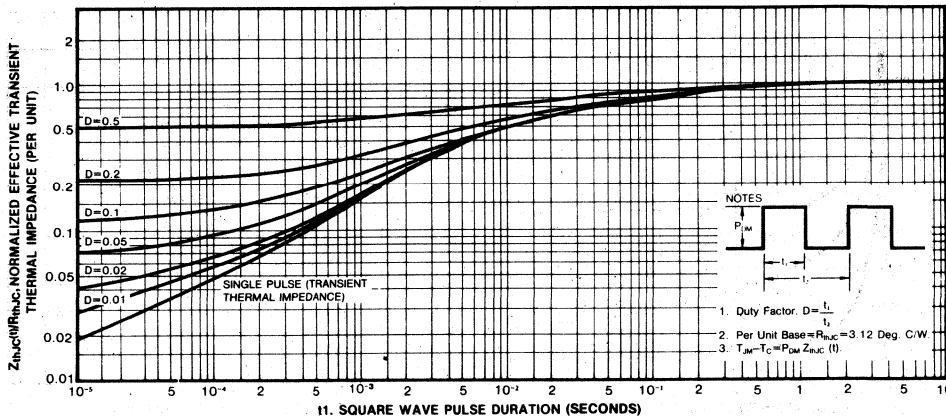

11. SQUARE WAVE PULSE DURATION (SECONDS)
Maximum Effective Transient Thermal Impedance Junction-to-Case Vs. Pulse Duration

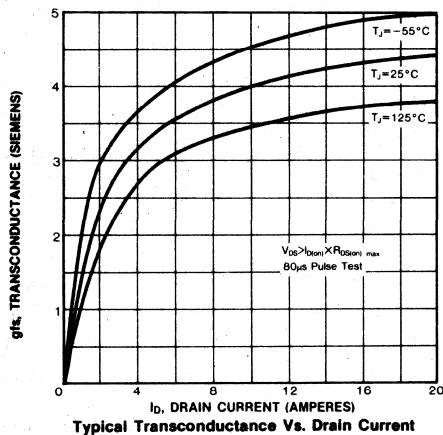

Typical Transconductance Vs. Drain Current

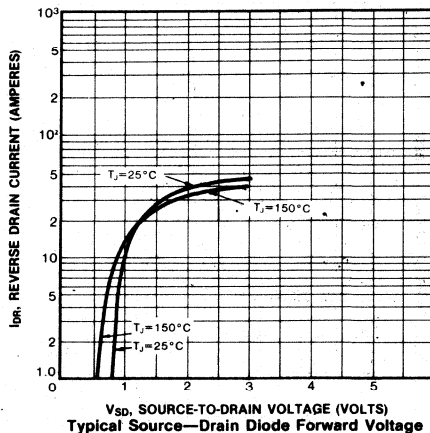

Typical Source-Drain Diode Forward Voltage

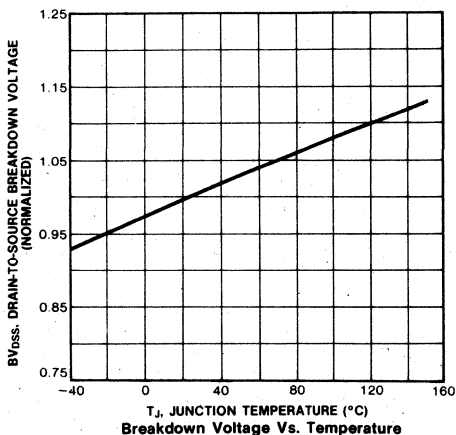

Breakdown Voltage Vs. Temperature

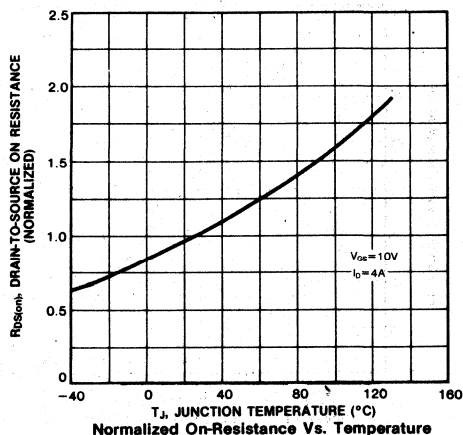

Normalized On-Resistance Vs. Temperature

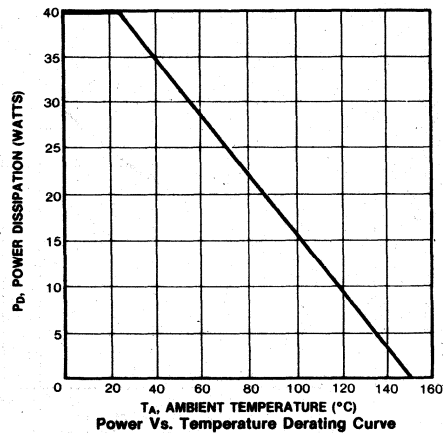
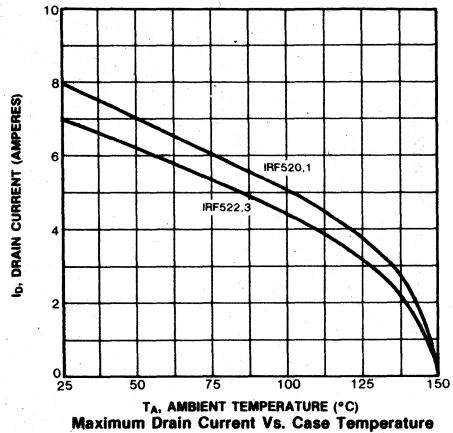
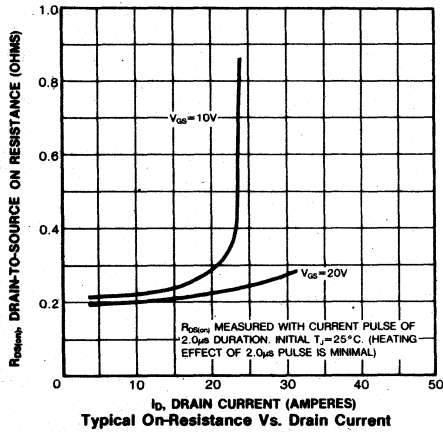
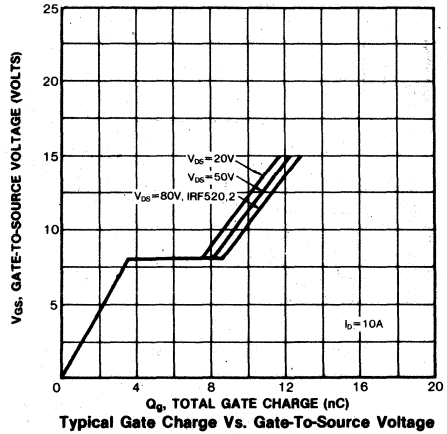
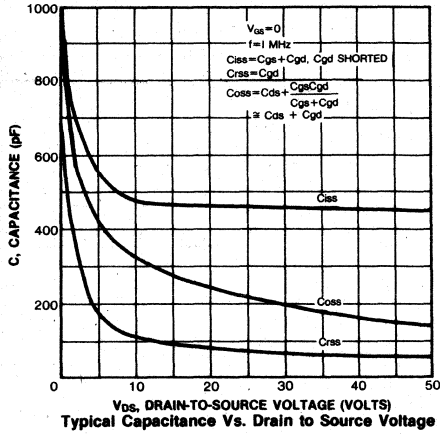

4

FEATURES

- Low $R_{DS(on)}$
- Improved inductive ruggedness
- Fast switching times
- Rugged polysilicon gate cell structure
- Low input capacitance
- Extended safe operating area
- Improved high temperature reliability
- TO-220 package

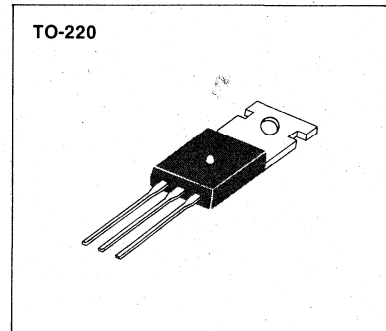

PRODUCT SUMMARY

Part Number	V_{DS}	$R_{DS(on)}$	I_D
IRF530	100V	0.18 Ω	14A
IRF531	60V	0.18 Ω	14A
IRF532	100V	0.25 Ω	12A
IRF533	60V	0.25 Ω	12A

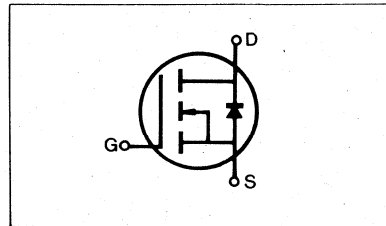

MAXIMUM RATINGS

Characteristic	Symbol	IRF530	IRF531	IRF532	IRF533	Unit
Drain-Source Voltage (1)	V_{DSS}	100	60	100	60	Vdc
Drain-Gate Voltage ($R_{GS}=1.0M\Omega$) (1)	V_{DGR}	100	60	100	60	Vdc
Gate-Source Voltage	V_{GS}	± 20				Vdc
Continuous Drain Current $T_C=25^\circ C$	I_D	14	14	12	12	Adc
Continuous Drain Current $T_C=100^\circ C$	I_D	9.0	9.0	8.0	8.0	Adc
Drain Current—Pulsed (3)	I_{DM}	56	56	48	48	Adc
Gate Current—Pulsed	I_{GM}	± 1.5				Adc
Total Power Dissipation @ $T_C=25^\circ C$ Derate above $25^\circ C$	P_D	75 0.6				Watts W/ $^\circ C$
Operating and Storage Junction Temperature Range	T_J, T_{stg}	-55 to 150				$^\circ C$
Maximum Lead Temp. for Soldering Purposes, 1/8" from case for 5 seconds	T_L	300				$^\circ C$

- Notes: (1) $T_J=25^\circ C$ to $150^\circ C$
 (2) Pulse test: Pulse width $\leq 300\mu s$, Duty Cycle $\leq 2\%$
 (3) Repetitive rating: Pulse width limited by max. junction temperature

ELECTRICAL CHARACTERISTICS (T_C=25°C unless otherwise specified)

Characteristic	Symbol	Type	Min	Typ	Max	Units	Test Conditions
Drain-Source Breakdown Voltage	BV _{DSS}	IRF530 IRF532	100	—	—	V	V _{GS} =0V
		IRF531 IRF533	60	—	—	V	I _D =250μA
Gate Threshold Voltage	V _{GS(th)}	ALL	2.0	—	4.0	V	V _{DS} =V _{GS} , I _D =250μA
Gate-Source Leakage Forward	I _{GSS}	ALL	—	—	100	nA	V _{GS} =20V
Gate-Source Leakage Reverse	I _{GSS}	ALL	—	—	-100	nA	V _{GS} =-20V
Zero Gate Voltage Drain Current	I _{DSS}	ALL	—	—	250	μA	V _{DS} =Max. Rating, V _{GS} =0V
			—	—	1000	μA	V _{DS} =Max. Rating×0.8, V _{GS} =0V, T _C =125°C
On-State Drain-Source Current (2)	I _{D(on)}	IRF530 IRF531	14	—	—	A	V _{DS} >I _{D(on)} ×R _{DS(on) max.} , V _{GS} =10V
		IRF532 IRF533	12	—	—	A	
Static Drain-Source On-State Resistance (2)	R _{DS(on)}	IRF530 IRF531	—	0.10	0.18	Ω	V _{GS} =10V, I _D =8.0A
		IRF532 IRF533	—	0.20	0.25	Ω	
Forward Transconductance (2)	g _{fs}	ALL	4.0	5.5	—	Ω	V _{DS} >I _{D(on)} ×R _{DS(on) max.} , I _D =8.0A
Input Capacitance	C _{iss}	ALL	—	680	800	pF	V _{GS} =0V, V _{DS} =25V, f=1.0MHz
Output Capacitance	C _{oss}	ALL	—	300	500	pF	
Reverse Transfer Capacitance	C _{rss}	ALL	—	100	150	pF	
Turn-On Delay Time	t _{d(on)}	ALL	—	—	30	ns	V _{DD} =0.5BV _{DSS} , I _D =8.0A, Z _O =15 Ω (MOSFET switching times are essentially independent of operating temperature)
Rise Time	t _r	ALL	—	—	75	ns	
Turn-Off Delay Time	t _{d(off)}	ALL	—	—	40	ns	
Fall Time	t _f	ALL	—	—	45	ns	
Total Gate Charge (Gate-Source Plus Gate-Drain)	Q _g	ALL	—	18	30	nC	V _{GS} =10V, I _D =18A, V _{DS} =0.8 Max. Rating (Gate charge is essentially independent of operating temperature.)
Gate-Source Charge	Q _{gs}	ALL	—	6.0	—	nC	
Gate-Drain ("Miller") Charge	Q _{gd}	ALL	—	12.0	—	nC	

THERMAL RESISTANCE

Junction-to-Case	R _{thJC}	ALL	—	—	1.67	K/W	
Case-to-Sink	R _{thCS}	ALL	—	1.0	—	K/W	Mounting surface flat, smooth, and greased
Junction-to-Ambient	R _{thJA}	ALL	—	—	80	K/W	Free Air Operation

- Notes:** (1) T_J=25°C to 150°C
 (2) Pulse test: Pulse width≤300μs, Duty Cycle≤2%
 (3) Repetitive rating: Pulse width limited by max. junction temperature

SOURCE-DRAIN DIODE RATINGS AND CHARACTERISTICS

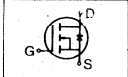
Characteristic	Symbol	Type	Min	Typ	Max	Units	Test Conditions
Continuous Source Current (Body Diode)	I_S	IRF530	—	—	14	A	Modified MOSFET symbol showing the integral reverse P-N junction rectifier 
		IRF531	—	—	14	A	
		IRF532	—	—	12	A	
		IRF533	—	—	12	A	
Pulse Source Current (Body Diode) (3)	I_{SM}	IRF530	—	—	56	A	
		IRF531	—	—	56	A	
		IRF532	—	—	48	A	
		IRF533	—	—	48	A	
Diode Forward Voltage (2)	V_{SD}	IRF530	—	—	2.5	V	$T_C=25^\circ\text{C}$, $I_S=14\text{A}$, $V_{GS}=0\text{V}$
		IRF531	—	—	2.5	V	$T_C=25^\circ\text{C}$, $I_S=14\text{A}$, $V_{GS}=0\text{V}$
		IRF532	—	—	2.3	V	$T_C=25^\circ\text{C}$, $I_S=12\text{A}$, $V_{GS}=0\text{V}$
Reverse Recovery Time	t_{rr}	ALL	—	360	—	ns	$T_J=150^\circ\text{C}$, $I_F=14\text{A}$, $di/dt=100\text{A}/\mu\text{s}$

Notes: (1) $T_J=25^\circ\text{C}$ to 150°C (2) Pulse test: Pulse width $\leq 300\mu\text{s}$, Duty Cycle $\leq 2\%$
 (3) Repetitive rating: Pulse width limited by max. junction temperature

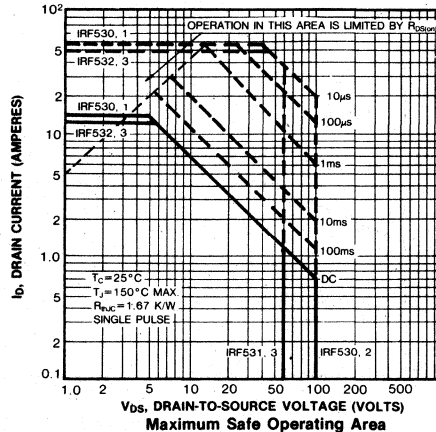
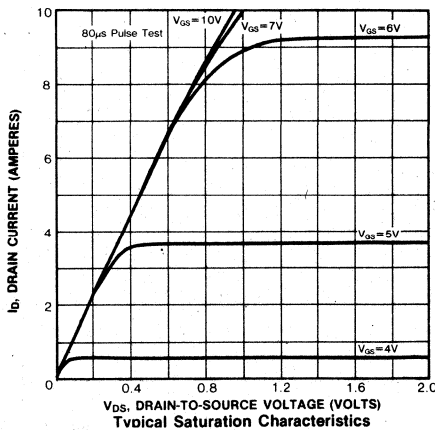
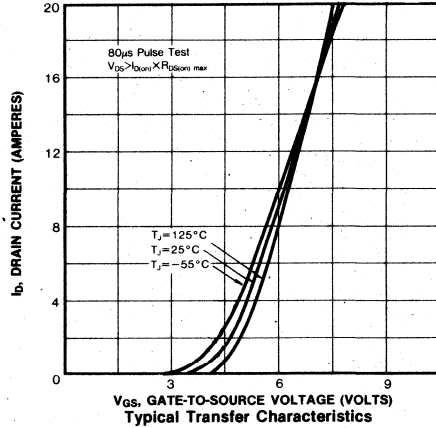
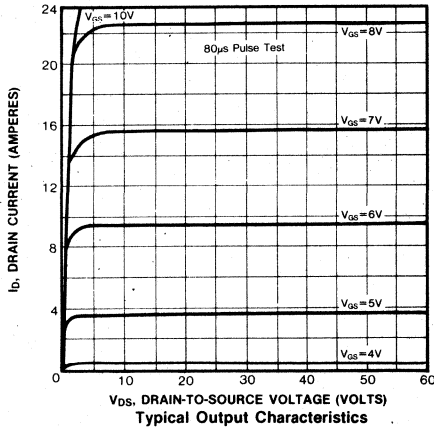

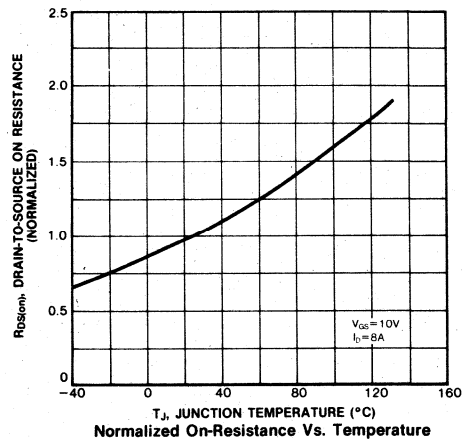
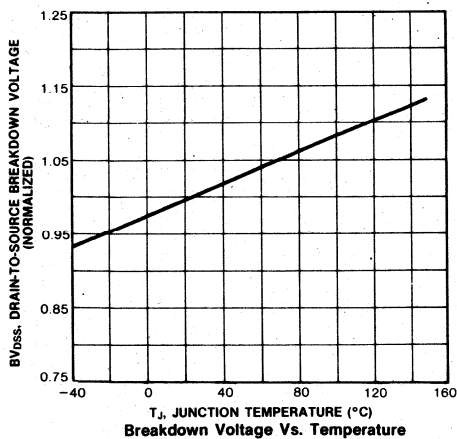
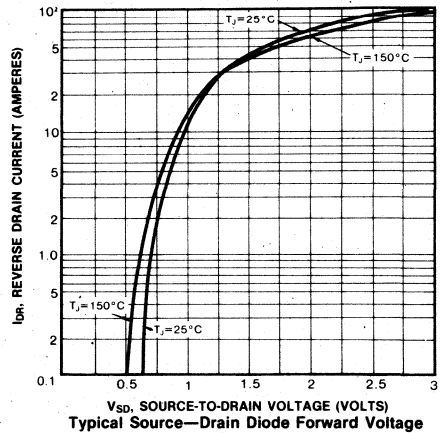
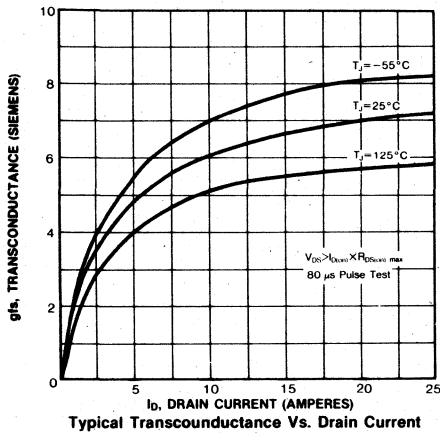
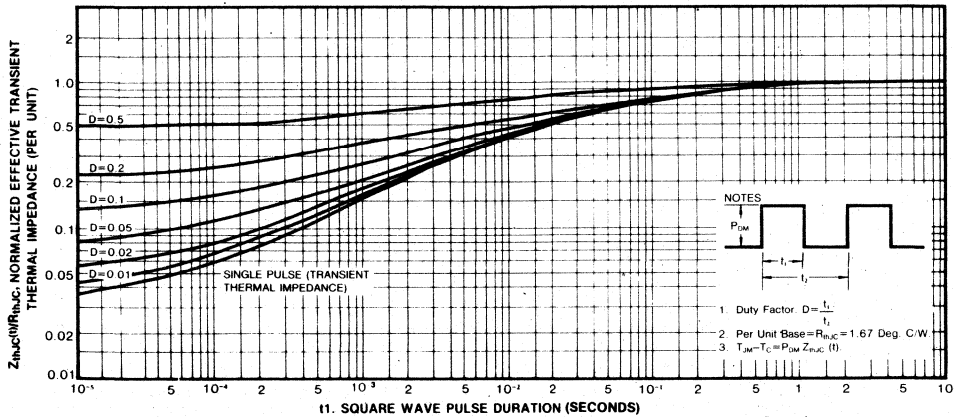

4

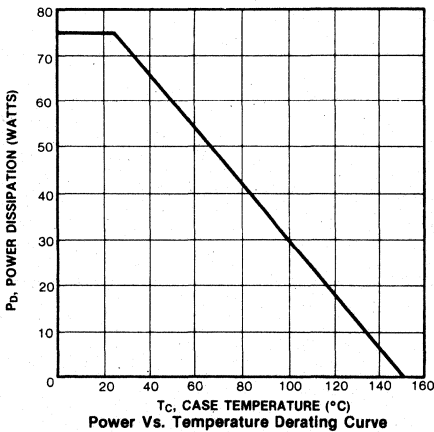
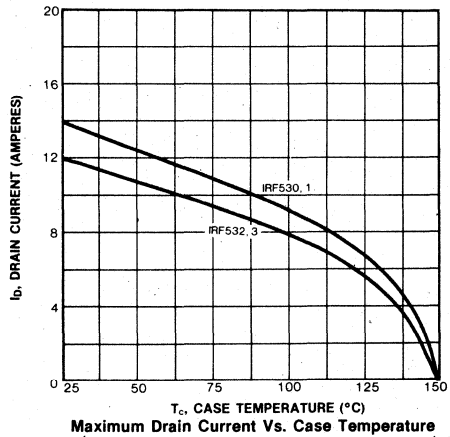
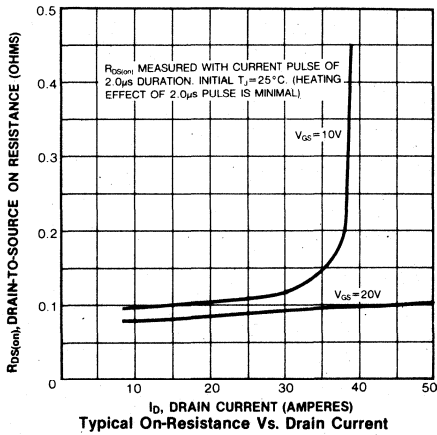
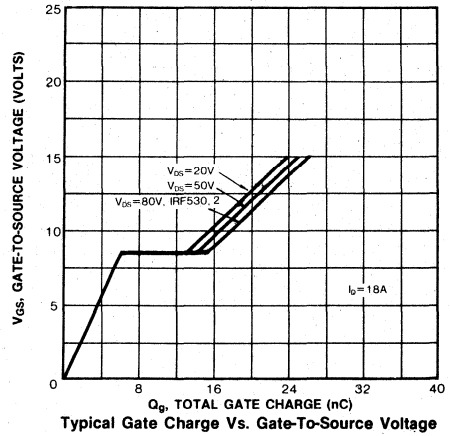
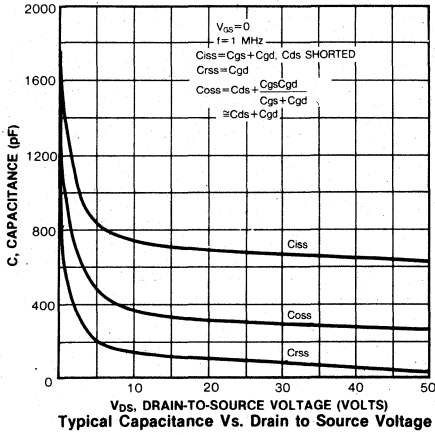

FEATURES

- Low $R_{DS(on)}$
- Improved inductive ruggedness
- Fast switching times
- Rugged polysilicon gate cell structure
- Low input capacitance
- Extended safe operating area
- Improved high temperature reliability
- TO-220 package

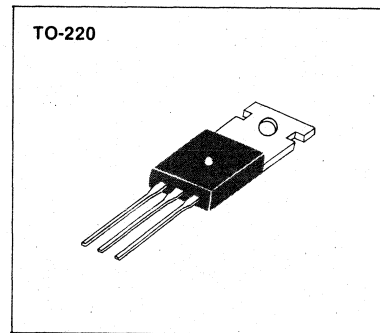

PRODUCT SUMMARY

Part Number	V_{DS}	$R_{DS(on)}$	I_D
IRF540	100V	0.085 Ω	27A
IRF541	60V	0.085 Ω	27A
IRF542	100V	0.11 Ω	24A
IRF543	60V	0.11 Ω	24A

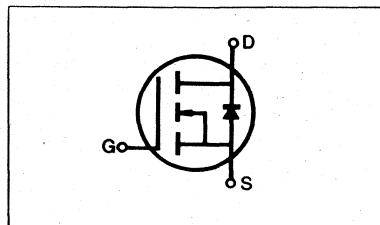

4

MAXIMUM RATINGS

Characteristic	Symbol	IRF540	IRF541	IRF542	IRF543	Unit
Drain-Source Voltage (1)	V_{DSS}	100	60	100	60	Vdc
Drain-Gate Voltage ($R_{GS}=1.0M\Omega$) (1)	V_{DGR}	100	60	100	60	Vdc
Gate-Source Voltage	V_{GS}	± 20				Vdc
Continuous Drain Current $T_C=25^\circ C$	I_D	27	27	24	24	Adc
Continuous Drain Current $T_C=100^\circ C$	I_D	17	17	15	15	Adc
Drain Current—Pulsed (3)	I_{DM}	108	108	96	96	Adc
Gate Current—Pulsed	I_{GM}	± 1.5				Adc
Total Power Dissipation @ $T_C=25^\circ C$ Derate above $25^\circ C$	P_D	125 1.0				Watts W/ $^\circ C$
Operating and Storage Junction Temperature Range	T_J, T_{stg}	-55 to 150				$^\circ C$
Maximum Lead Temp. for Soldering Purposes, 1/8" from case for 5 seconds	T_L	300				$^\circ C$

- Notes:** (1) $T_J=25^\circ C$ to $150^\circ C$
 (2) Pulse test: Pulse width $\leq 300\mu s$, Duty Cycle $\leq 2\%$
 (3) Repetitive rating: Pulse width limited by max. junction temperature

ELECTRICAL CHARACTERISTICS (T_C=25°C unless otherwise specified)

Characteristic	Symbol	Type	Min	Typ	Max	Units	Test Conditions
Drain-Source Breakdown Voltage	BV _{DSS}	IRF540	100	—	—	V	V _{GS} =0V I _D =250μA
		IRF542					
		IRF541	60	—	—	V	
		IRF543					
Gate Threshold Voltage	V _{GS(th)}	ALL	2.0	—	4.0	V	V _{DS} =V _{GS} , I _D =250μA
Gate-Source Leakage Forward	I _{GSS}	ALL	—	—	100	nA	V _{GS} =20V
Gate-Source Leakage Reverse	I _{GSS}	ALL	—	—	-100	nA	V _{GS} =-20V
Zero Gate Voltage Drain Current	I _{DSS}	ALL	—	—	250	μA	V _{DS} =Max. Rating, V _{GS} =0V
			—	—	1000	μA	V _{DS} =Max. Rating×0.8, V _{GS} =0V, T _C =125°C
On-State Drain-Source Current (2)	I _{D(on)}	IRF540	27	—	—	A	V _{DS} >I _{D(on)} ×R _{DS(on) max.} , V _{GS} =10V
		IRF541					
		IRF542	24	—	—	A	
		IRF543					
Static Drain-Source On-State Resistance (2)	R _{DS(on)}	IRF540	—	0.06	0.085	Ω	V _{GS} =10V, I _D =15A
		IRF541					
		IRF542	—	0.09	0.11	Ω	
		IRF543					
Forward Transconductance (2)	g _{fs}	ALL	6.0	10.5	—	♢	V _{DS} >I _{D(on)} ×R _{DS(on) max.} , I _D =15A
Input Capacitance	C _{iss}	ALL	—	1320	1600	pF	
Output Capacitance	C _{oss}	ALL	—	600	800	pF	V _{GS} =0V, V _{DS} =25V, f=1.0MHz
Reverse Transfer Capacitance	C _{rss}	ALL	—	250	300	pF	
Turn-On Delay Time	t _{d(on)}	ALL	—	—	30	ns	V _{DD} =0.5BV _{DSS} , I _D =15A, Z _O =4.7 Ω (MOSFET switching times are essentially independent of operating temperature.)
Rise Time	t _r	ALL	—	—	60	ns	
Turn-Off Delay Time	t _{d(off)}	ALL	—	—	80	ns	
Fall Time	t _f	ALL	—	—	30	ns	
Total Gate Charge (Gate-Source Plus Gate-Drain)	Q _g	ALL	—	39	60	nC	
Gate-Source Charge	Q _{gs}	ALL	—	12	—	nC	V _{GS} =10V, I _D =34A, V _{DS} =0.8 Max. Rating (Gate charge is essentially independent of operating temperature.)
Gate-Drain ("Miller") Charge	Q _{gd}	ALL	—	27	—	nC	

THERMAL RESISTANCE

Junction-to-Case	R _{thJC}	ALL	—	—	1.0	K/W	
Case-to-Sink	R _{thCS}	ALL	—	1.0	—	K/W	Mounting surface flat, smooth, and greased
Junction-to-Ambient	R _{thJA}	ALL	—	—	80	K/W	Free Air Operation

Notes: (1) T_J=25°C to 150°C

(2) Pulse test: Pulse width≤300μs, Duty Cycle≤2%

(3) Repetitive rating: Pulse width limited by max. junction temperature

SOURCE-DRAIN DIODE RATINGS AND CHARACTERISTICS

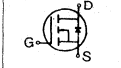
Characteristic	Symbol	Type	Min	Typ	Max	Units	Test Conditions
Continuous Source Current (Body Diode)	I _S	IRF540	—	—	27	A	Modified MOSFET symbol showing the integral reverse P-N junction rectifier 
		IRF541	—	—	27	A	
		IRF542	—	—	24	A	
		IRF543	—	—	24	A	
Pulse Source Current (Body Diode) (3)	I _{SM}	IRF540	—	—	108	A	
		IRF541	—	—	108	A	
		IRF542	—	—	96	A	
		IRF543	—	—	96	A	
Diode Forward Voltage (2)	V _{SD}	IRF540	—	—	2.5	V	T _C =25°C, I _S =27A, V _{GS} =0V
		IRF541	—	—	2.5	V	T _C =25°C, I _S =24A, V _{GS} =0V
		IRF542	—	—	2.3	V	T _C =25°C, I _S =24A, V _{GS} =0V
Reverse Recovery Time	t _{rr}	ALL	—	500	—	ns	T _J =150°C, I _F =27A, dI _F /dt=100A/μs

Notes: (1) T_J=25°C to 150°C (2) Pulse test: Pulse width ≤ 300μs, Duty Cycle ≤ 2%
 (3) Repetitive rating: Pulse width limited by max. junction temperature

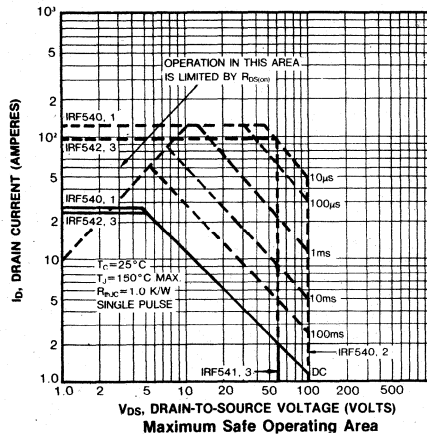
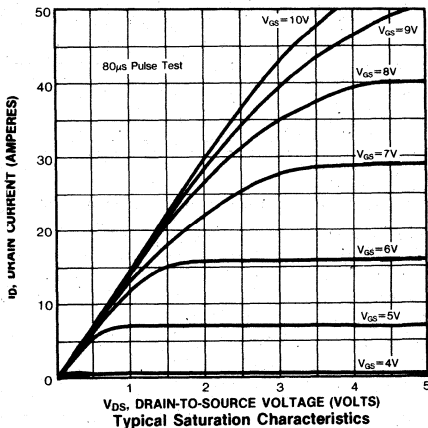
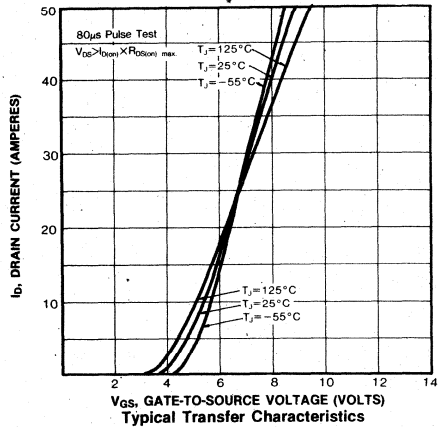
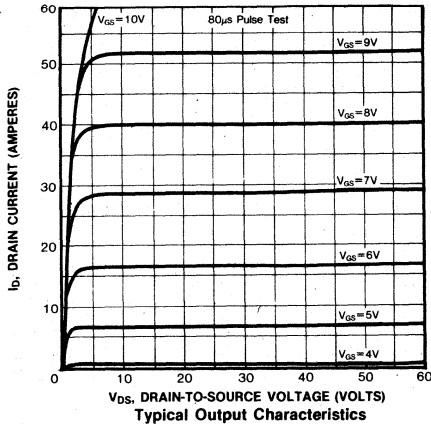

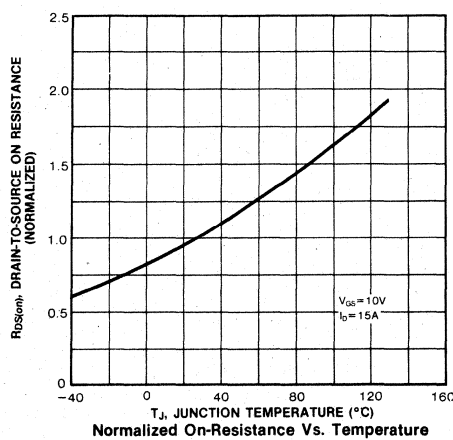
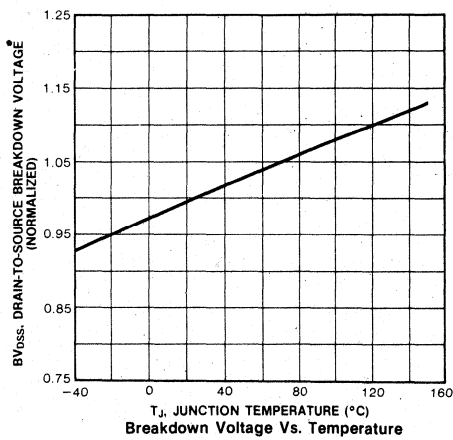
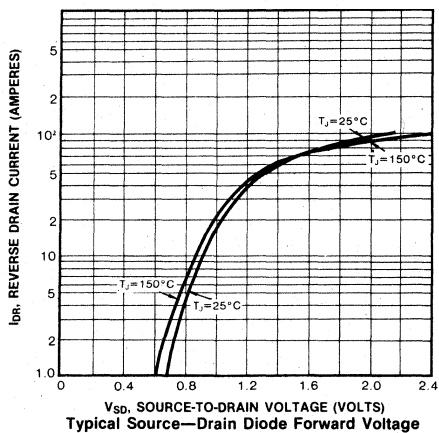
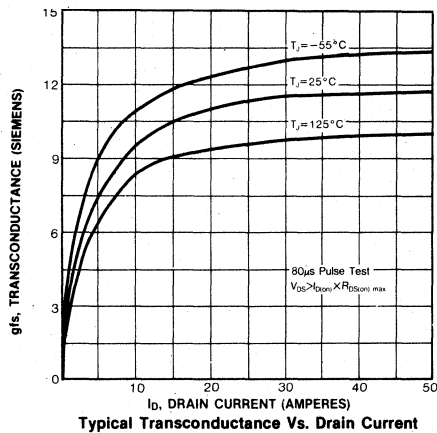
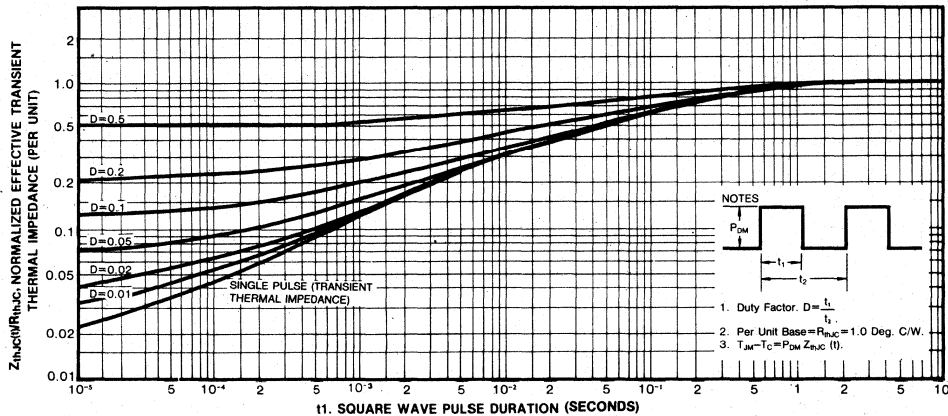

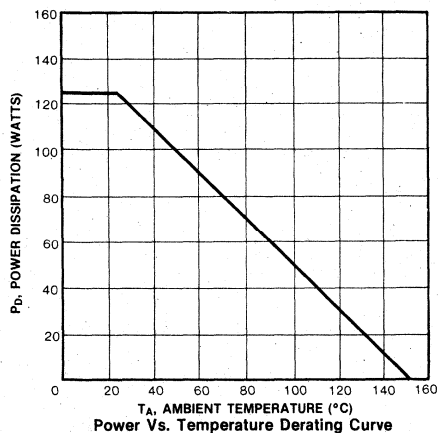
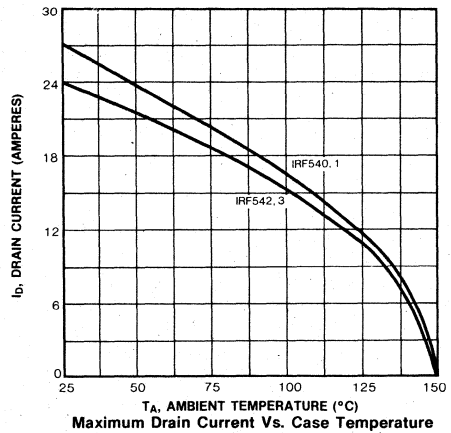
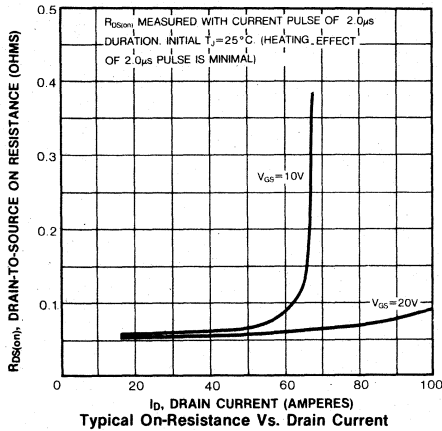
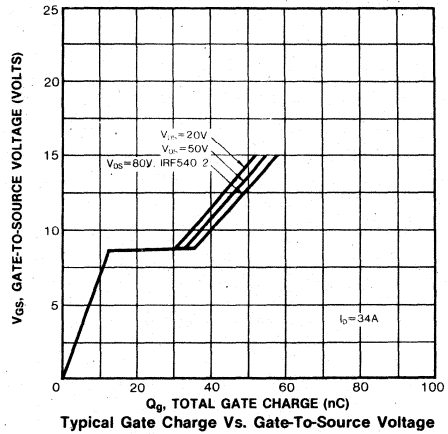
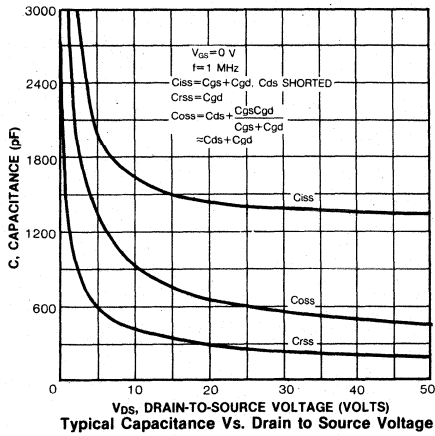

FEATURES

- Low $R_{DS(on)}$
- Improved inductive ruggedness
- Fast switching times
- Rugged polysilicon gate cell structure
- Low input capacitance
- Extended safe operating area
- Improved high temperature reliability
- TO-220 package

PRODUCT SUMMARY

Part Number	V_{DS}	$R_{DS(on)}$	I_D
IRF610	200V	1.5 Ω	2.5A
IRF611	150V	1.5 Ω	2.5A
IRF612	200V	2.4 Ω	2.0A
IRF613	150V	2.4 Ω	2.0A

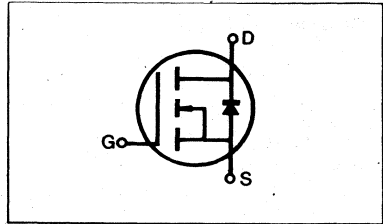
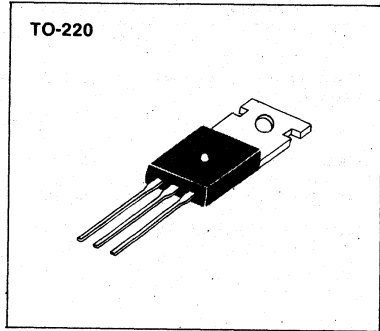

MAXIMUM RATINGS

Characteristic	Symbol	IRF610	IRF611	IRF612	IRF613	Unit
Drain-Source Voltage (1)	V_{DSS}	200	150	200	150	Vdc
Drain-Gate Voltage ($R_{GS}=1.0M\Omega$)(1)	V_{DGR}	200	150	200	150	Vdc
Gate-Source Voltage	V_{GS}	± 20				Vdc
Continuous Drain Current $T_C=25^\circ C$	I_D	2.5	2.5	2.0	2.0	Adc
Continuous Drain Current $T_C=100^\circ C$	I_D	1.5	1.5	1.25	1.25	Adc
Drain Current—Pulsed (3)	I_{DM}	10	10	8.0	8.0	Adc
Gate Current—Pulsed	I_{GM}	± 1.5				Adc
Total Power Dissipation @ $T_C=25^\circ C$ Derate above $25^\circ C$	P_D	20 0.16				Watts W/ $^\circ C$
Operating and Storage Junction Temperature Range	T_J, T_{stg}	-55 to 150				$^\circ C$
Maximum Lead Temp. for Soldering Purposes, 1/8" from case for 5 seconds	T_L	300				$^\circ C$

- Notes:** (1) $T_J=25^\circ C$ to $150^\circ C$
 (2) Pulse test: Pulse width $\leq 300\mu s$, Duty Cycle $\leq 2\%$
 (3) Repetitive rating: Pulse width limited by max. junction temperature

ELECTRICAL CHARACTERISTICS (T_C=25°C unless otherwise specified)

Characteristic	Symbol	Type	Min	Typ	Max	Units	Test Conditions
Drain-Source Breakdown Voltage	BV _{DSS}	IRF610 IRF612	200	—	—	V	V _{GS} =0V
		IRF611 IRF613	150	—	—	V	I _D =250μA
Gate Threshold Voltage	V _{GS(th)}	ALL	2.0	—	4.0	V	V _{DS} =V _{GS} , I _D =250μA
Gate-Source Leakage Forward	I _{GSS}	ALL	—	—	100	nA	V _{GS} =20V
Gate-Source Leakage Reverse	I _{GSS}	ALL	—	—	-100	nA	V _{GS} =-20V
Zero Gate Voltage Drain Current	I _{DSS}	ALL	—	—	250	μA	V _{DS} =Max. Rating, V _{GS} =0V
			—	—	1000	μA	V _{DS} =Max. Rating×0.8, V _{GS} =0V, T _C =125°C
On-State Drain-Source Current (2)	I _{D(on)}	IRF610 IRF611	2.5	—	—	A	V _{DS} >I _{D(on)} ×R _{DS(on)} max., V _{GS} =10V
		IRF612 IRF613	2.0	—	—	A	
Static Drain-Source On-State Resistance (2)	R _{DS(on)}	IRF610 IRF611	—	0.9	1.5	Ω	V _{GS} =10V, I _D =1.25A
		IRF612 IRF613	—	1.5	2.4	Ω	
Forward Transconductance (2)	g _{fs}	ALL	0.8	1.4	—	Ω	V _{DS} >I _{D(on)} ×R _{DS(on)} max., I _D =1.25A
Input Capacitance	C _{iss}	ALL	—	140	150	pF	V _{GS} =0V, V _{DS} =25V, f=1.0MHz
Output Capacitance	C _{oss}	ALL	—	70	80	pF	
Reverse Transfer Capacitance	C _{rss}	ALL	—	22	25	pF	
Turn-On Delay Time	t _{d(on)}	ALL	—	—	15	ns	V _{DD} =0.5BV _{DSS} , I _D =1.25A, Z _O =50Ω, (MOSFET switching times are essentially independent of operating temperature.)
Rise Time	t _r	ALL	—	—	25	ns	
Turn-Off Delay Time	t _{d(off)}	ALL	—	—	15	ns	
Fall Time	t _f	ALL	—	—	15	ns	
Total Gate Charge (Gate-Source Plus Gate-Drain)	Q _g	ALL	—	5.8	7.5	nC	V _{GS} =10V, I _D =3.0A, V _{DS} =0.8 Max. Rating (Gate charge is essentially independent of operating temperature.)
Gate-Source Charge	Q _{gs}	ALL	—	1.9	—	nC	
Gate-Drain ("Miller") Charge	Q _{gd}	ALL	—	3.9	—	nC	

THERMAL RESISTANCE

Junction-to-Case	R _{thJC}	ALL	—	—	6.4	K/W	
Case-to-Sink	R _{thCS}	ALL	—	1.0	—	K/W	Mounting surface flat, smooth, and greased
Junction-to-Ambient	R _{thJA}	ALL	—	—	80	K/W	Free Air Operation

- Notes:** (1) T_J=25°C to 150°C
 (2) Pulse test: Pulse width≤300μs, Duty Cycle≤2%
 (3) Repetitive rating: Pulse width limited by max. junction temperature

SOURCE-DRAIN DIODE RATINGS AND CHARACTERISTICS

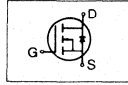
Characteristic	Symbol	Type	Min	Typ	Max	Units	Test Conditions
Continuous Source Current (Body Diode)	I_S	IRF610	—	—	2.5	A	Modified MOSFET symbol showing the integral reverse P-N junction rectifier 
		IRF611	—	—	2.5	A	
		IRF612	—	—	2.0	A	
		IRF613	—	—	2.0	A	
Pulse Source Current (Body Diode) (3)	I_{SM}	IRF610	—	—	10	A	
		IRF611	—	—	10	A	
		IRF612	—	—	8.0	A	
		IRF613	—	—	8.0	A	
Diode Forward Voltage (2)	V_{SD}	IRF610	—	—	2.0	V	$T_C=25^\circ\text{C}$, $I_S=2.5\text{A}$, $V_{GS}=0\text{V}$
		IRF611	—	—	2.0	V	$T_C=25^\circ\text{C}$, $I_S=2.5\text{A}$, $V_{GS}=0\text{V}$
		IRF612	—	—	1.8	V	$T_C=25^\circ\text{C}$, $I_S=2.0\text{A}$, $V_{GS}=0\text{V}$
		IRF613	—	—	1.8	V	$T_C=25^\circ\text{C}$, $I_S=2.0\text{A}$, $V_{GS}=0\text{V}$
Reverse Recovery Time	t_{rr}	ALL	—	290	—	ns	$T_J=150^\circ\text{C}$, $I_F=2.5\text{A}$, $di/dt=100\text{A}/\mu\text{s}$

Notes: (1) $T_J=25^\circ\text{C}$ to 150°C (2) Pulse test: Pulse width $\leq 300\mu\text{s}$, Duty Cycle $\leq 2\%$
 (3) Repetitive rating: Pulse width limited by max. junction temperature

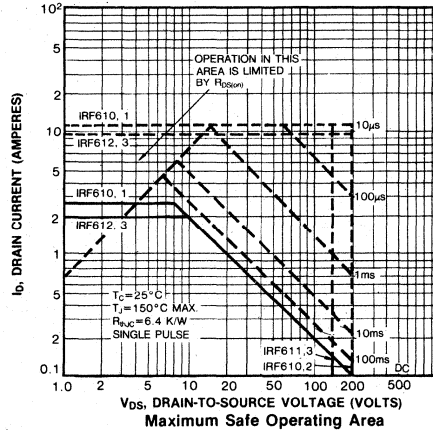
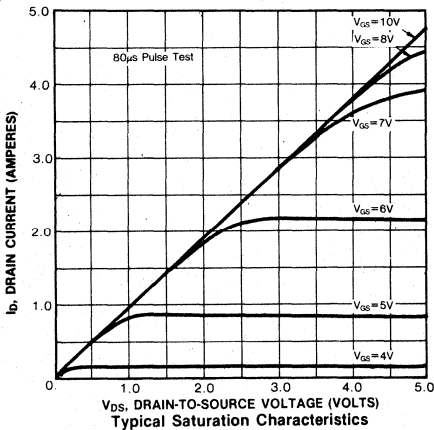
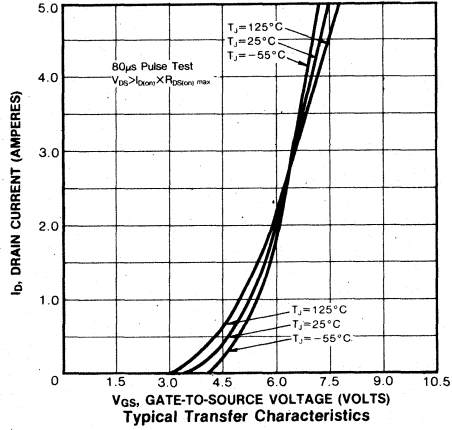
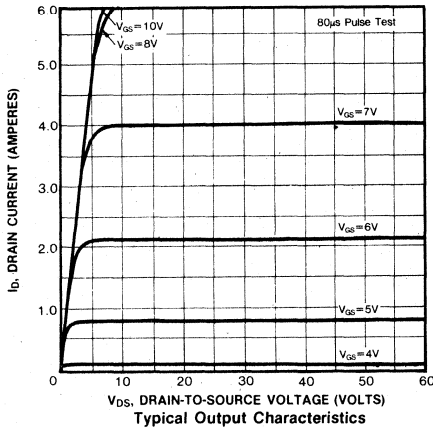

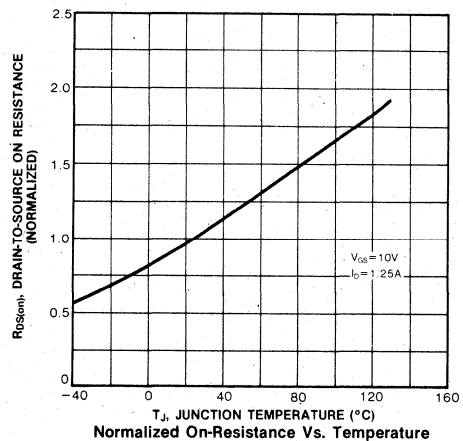
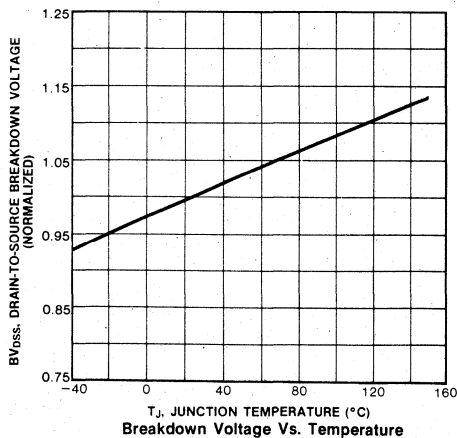
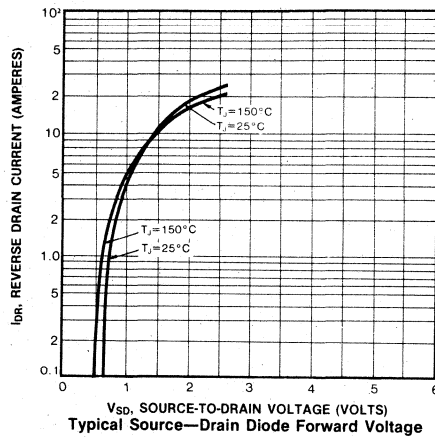
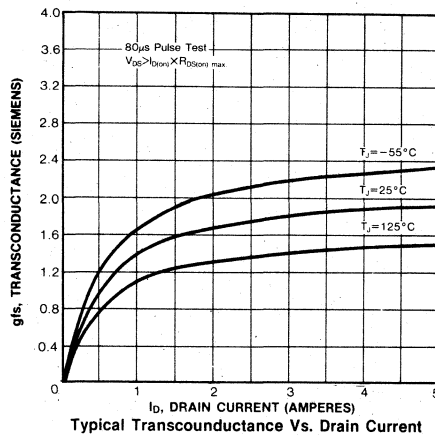
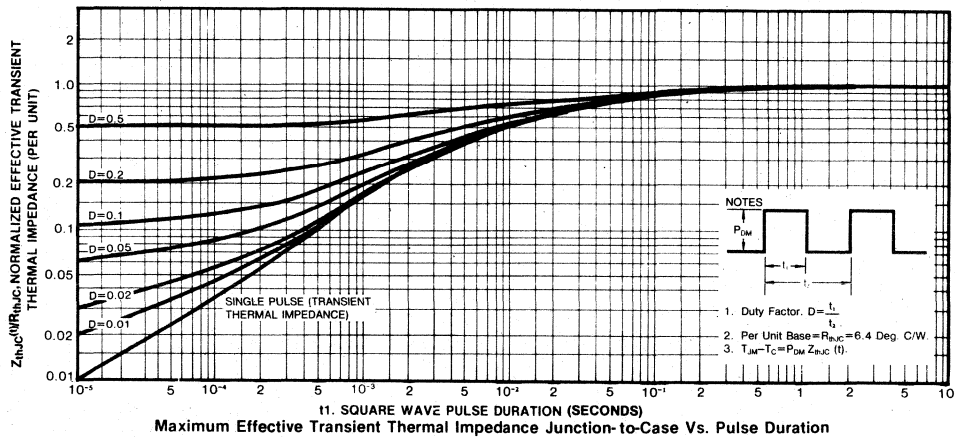

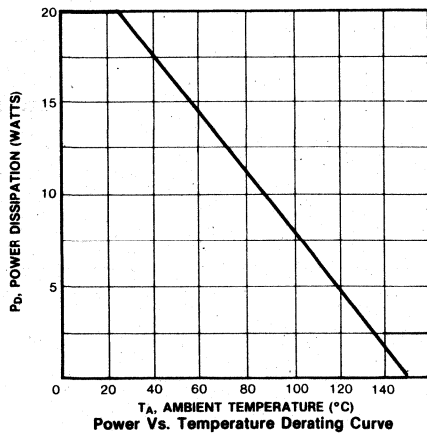
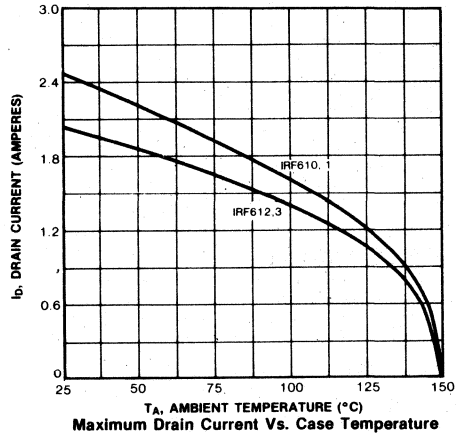
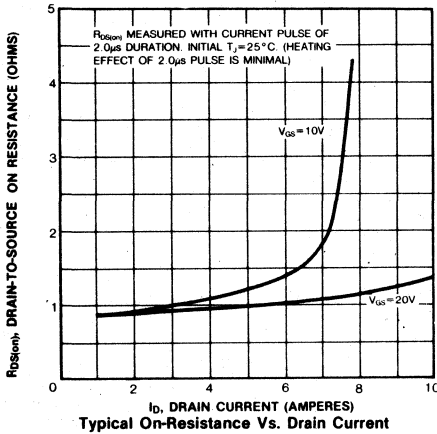
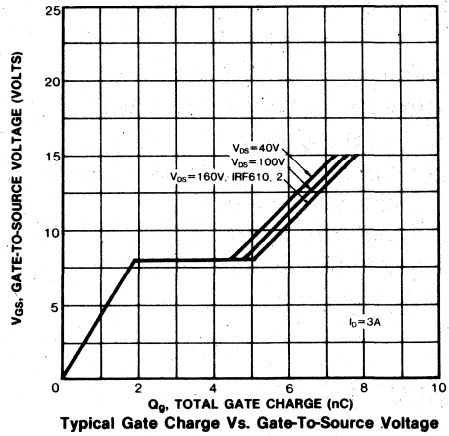
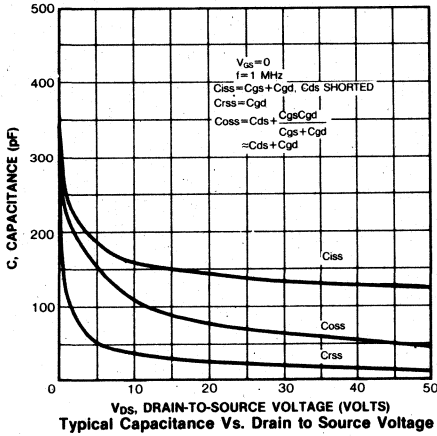

FEATURES

- Low $R_{DS(on)}$
- Improved inductive ruggedness
- Fast switching times
- Rugged polysilicon gate cell structure
- Low input capacitance
- Extended safe operating area
- Improved high temperature reliability
- TO-220 package

PRODUCT SUMMARY

Part Number	V_{DS}	$R_{DS(on)}$	I_D
IRF620	200V	0.8 Ω	5.0A
IRF621	150V	0.8 Ω	5.0A
IRF622	200V	1.2 Ω	4.0A
IRF623	150V	1.2 Ω	4.0A

TO-220

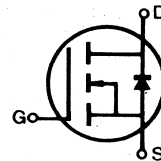
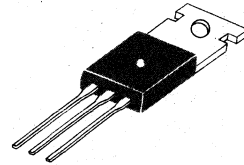

MAXIMUM RATINGS

Characteristic	Symbol	IRF620	IRF621	IRF622	IRF623	Unit
Drain-Source Voltage (1)	V_{DS}	200	150	200	150	Vdc
Drain-Gate Voltage ($R_{GS}=1.0M\Omega$) (1)	V_{DGR}	200	150	200	150	Vdc
Gate-Source Voltage	V_{GS}	± 20				Vdc
Continuous Drain Current $T_C=25^\circ C$	I_D	5.0	5.0	4.0	4.0	Adc
Continuous Drain Current $T_C=100^\circ C$	I_D	3.0	3.0	2.5	2.5	Adc
Drain Current—Pulsed (3)	I_{DM}	20	20	16	16	Adc
Gate Current—Pulsed	I_{GM}	± 1.5				Adc
Total Power Dissipation @ $T_C=25^\circ C$ Derate above $25^\circ C$	P_D	40 0.32				Watts W/ $^\circ C$
Operating and Storage Junction Temperature Range	T_J, T_{stg}	-55 to 150				$^\circ C$
Maximum Lead Temp. for Soldering Purposes, 1/8" from case for 5 seconds	T_L	300				$^\circ C$

ELECTRICAL CHARACTERISTICS (T_C=25°C unless otherwise specified)

Characteristic	Symbol	Type	Min	Typ	Max	Units	Test Conditions
Drain-Source Breakdown Voltage	BV _{DSS}	IRF620 IRF622	200	—	—	V	V _{GS} =0V
		IRF621 IRF623	150	—	—	V	I _D =250μA
Gate Threshold Voltage	V _{GS(th)}	ALL	2.0	—	4.0	V	V _{DS} =V _{GS} , I _D =250μA
Gate-Source Leakage Forward	I _{GSS}	ALL	—	—	100	nA	V _{GS} =20V
Gate-Source Leakage Reverse	I _{GSS}	ALL	—	—	-100	nA	V _{GS} =-20V
Zero Gate Voltage Drain Current	I _{DSS}	ALL	—	—	250	μA	V _{DS} =Max. Rating, V _{GS} =0V
			—	—	1000	μA	V _{DS} =Max. Rating×0.8, V _{GS} =0V, T _C =125°C
On-State Drain-Source Current (2)	I _{D(on)}	IRF620 IRF621	5.0	—	—	A	V _{DS} >I _{D(on)} ×R _{DS(on) max.} , V _{GS} =10V
		IRF622 IRF623	4.0	—	—	A	
Static Drain-Source On-State Resistance (2)	R _{DS(on)}	IRF620 IRF621	—	0.4	0.8	Ω	V _{GS} =10V, I _D =2.5A
		IRF622 IRF623	—	0.8	1.2	Ω	
Forward Transconductance (2)	g _{fs}	ALL	1.3	2.8	—	♢	V _{DS} >I _{D(on)} ×R _{DS(on) max.} , I _D =2.5A
Input Capacitance	C _{iss}	ALL	—	450	600	pF	V _{GS} =0V, V _{DS} =25V, f=1.0MHz
Output Capacitance	C _{oss}	ALL	—	150	300	pF	
Reverse Transfer Capacitance	C _{rss}	ALL	—	50	80	pF	
Turn-On Delay Time	t _{d(on)}	ALL	—	—	40	ns	V _{DD} =0.5BV _{DSS} , I _D =2.5A, Z _O =50 Ω, (MOSFET switching times are essentially independent of operating temperature.)
Rise Time	t _r	ALL	—	—	60	ns	
Turn-Off Delay Time	t _{d(off)}	ALL	—	—	100	ns	
Fall Time	t _f	ALL	—	—	60	ns	V _{GS} =10V, I _D =6.0A, V _{DS} =0.8 Max. Rating (Gate charge is essentially independent of operating temperature.)
Total Gate Charge (Gate-Source Plus Gate-Drain)	Q _g	ALL	—	12.5	15	nC	
Gate-Source Charge	Q _{gs}	ALL	—	4.0	—	nC	
Gate-Drain ("Miller") Charge	Q _{gd}	ALL	—	8.5	—	nC	

THERMAL RESISTANCE

Junction-to-Case	R _{thJC}	ALL	—	—	3.12	K/W	
Case-to-Sink	R _{thCS}	ALL	—	1.0	—	K/W	Mounting surface flat, smooth, and greased
Junction-to-Ambient	R _{thJA}	ALL	—	—	80	K/W	Free Air Operation

- Notes:** (1) T_J=25°C to 150°C
 (2) Pulse test: Pulse width≤300μs, Duty Cycle≤2%
 (3) Repetitive rating: Pulse width limited by max. junction temperature

SOURCE-DRAIN DIODE RATINGS AND CHARACTERISTICS

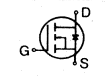
Characteristic	Symbol	Type	Min	Typ	Max	Units	Test Conditions
Continuous Source Current (Body Diode)	I _S	IRF620 IRF621	—	—	5.0	A	Modified MOSFET symbol showing the integral reverse P-N junction rectifier 
		IRF622 IRF623	—	—	4.0	A	
Pulse Source Current (Body Diode) (3)	I _{SM}	IRF620 IRF621	—	—	20	A	
		IRF622 IRF623	—	—	16	A	
Diode Forward Voltage (2)	V _{SD}	IRF620 IRF621	—	—	1.8	V	T _C =25°C, I _S =5.0A, V _{GS} =0V
		IRF622 IRF623	—	—	1.6	V	T _C =25°C, I _S =4.0A, V _{GS} =0V
Reverse Recovery Time	t _{rr}	ALL	—	350	—	ns	T _J =150°C, I _F =5.0A, dI _F /dt=100A/μs

Notes: (1) T_J=25°C to 150°C (2) Pulse test: Pulse width ≤ 300μs, Duty Cycle ≤ 2%
(3) Repetitive rating: Pulse width limited by max. junction temperature

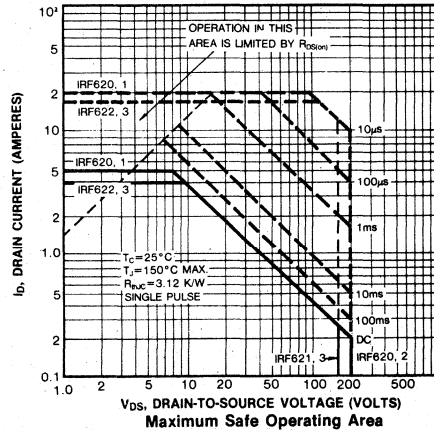
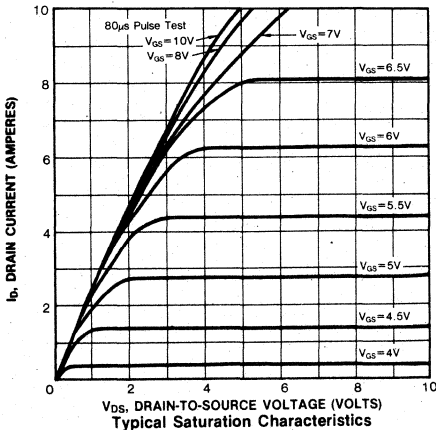
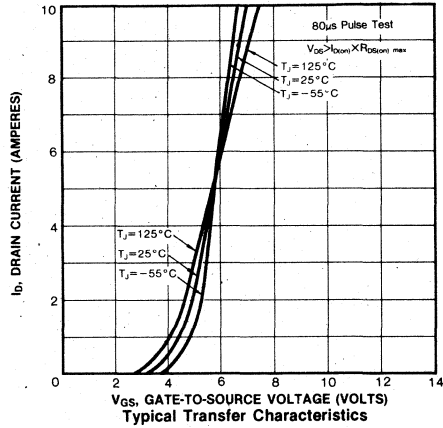
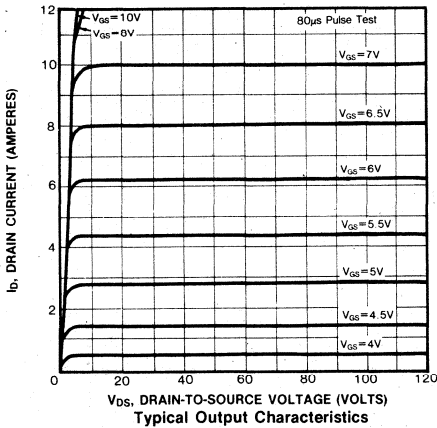

4

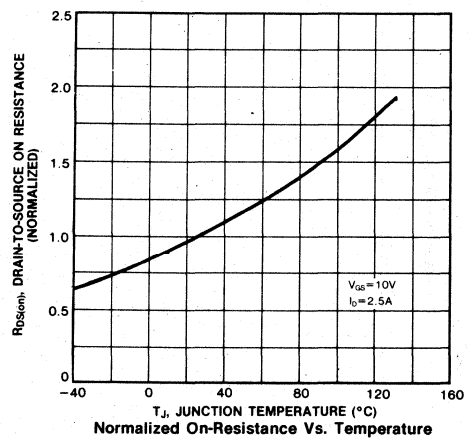
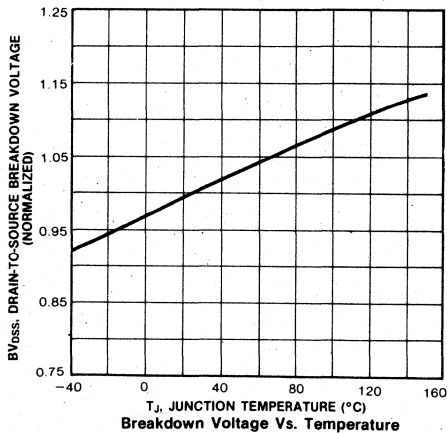
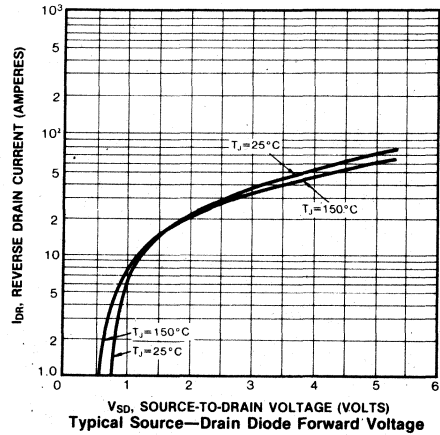
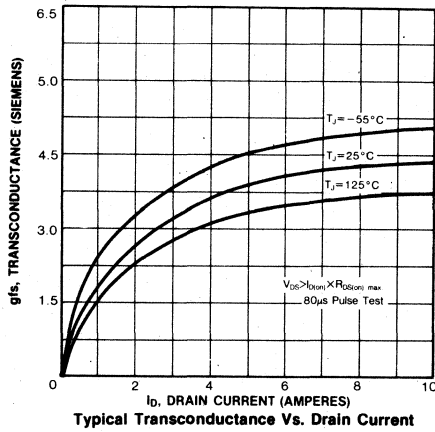
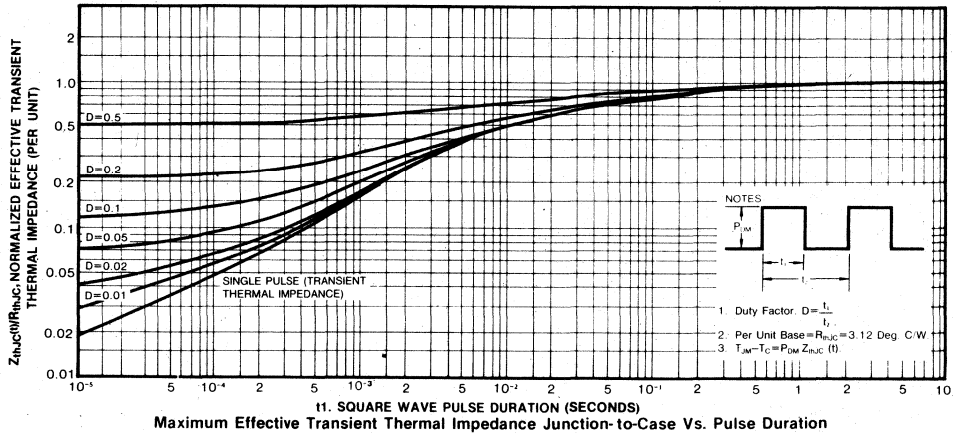

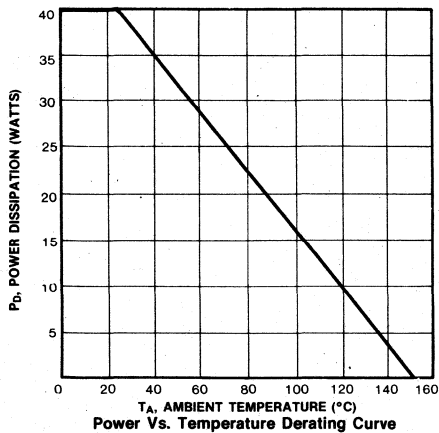
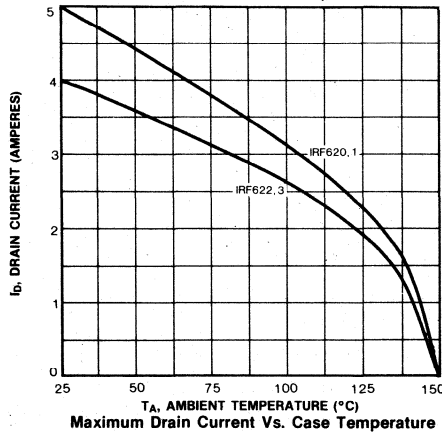
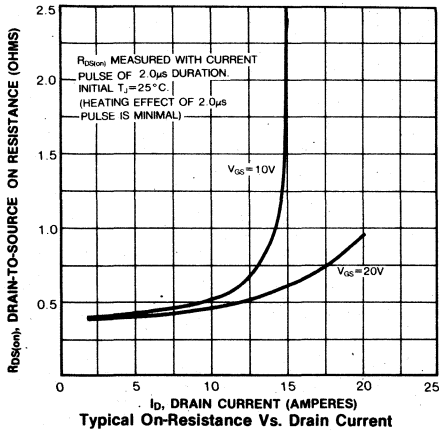
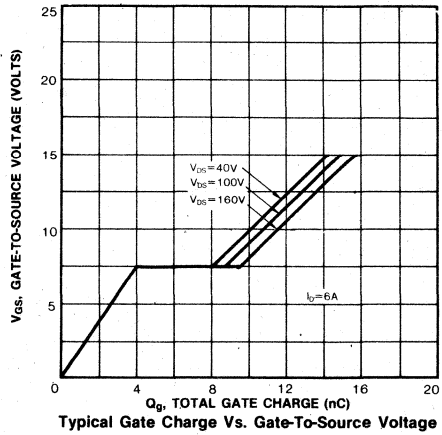
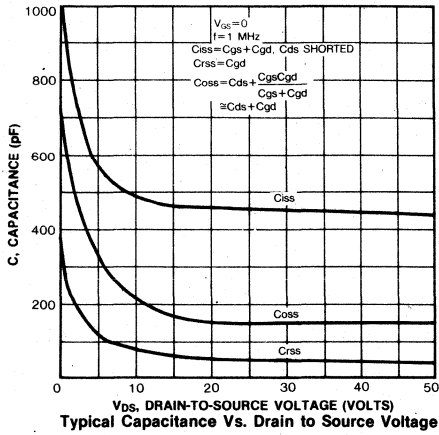

4

FEATURES

- Low $R_{DS(on)}$
- Improved inductive ruggedness
- Fast switching times
- Rugged polysilicon gate cell structure
- Low input capacitance
- Extended safe operating area
- Improved high temperature reliability
- TO-220 package

PRODUCT SUMMARY

Part Number	V_{DS}	$R_{DS(on)}$	I_D
IRF630	200V	0.4 Ω	9.0A
IRF631	150V	0.4 Ω	9.0A
IRF632	200V	0.6 Ω	8.0A
IRF633	150V	0.6 Ω	8.0A

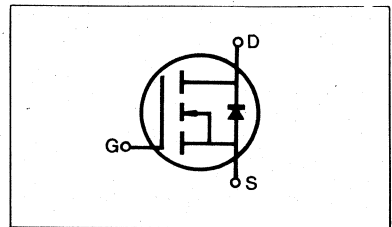
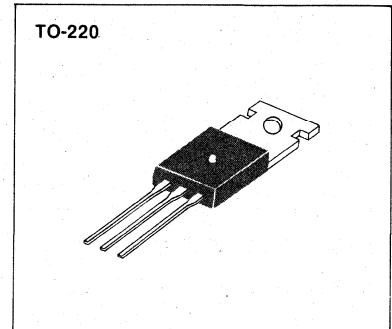

MAXIMUM RATINGS

Characteristic	Symbol	IRF630	IRF631	IRF632	IRF633	Unit
Drain-Source Voltage (1)	V_{DSS}	200	150	200	150	Vdc
Drain-Gate Voltage ($R_{GS}=1.0M\Omega$) (1)	V_{DGR}	200	150	200	150	Vdc
Gate-Source Voltage	V_{GS}	± 20				Vdc
Continuous Drain Current $T_C=25^\circ C$	I_D	9.0	9.0	8.0	8.0	Adc
Continuous Drain Current $T_C=100^\circ C$	I_D	6.0	6.0	5.0	5.0	Adc
Drain Current—Pulsed (3)	I_{DM}	36	36	32	32	Adc
Gate Current—Pulsed	I_{GM}	± 1.5				Adc
Total Power Dissipation @ $T_C=25^\circ C$ Derate above $25^\circ C$	P_D	75 0.6				Watts W/ $^\circ C$
Operating and Storage Junction Temperature Range	T_J, T_{stg}	-55 to 150				$^\circ C$
Maximum Lead Temp. for Soldering Purposes, 1/8" from case for 5 seconds	T_L	300				$^\circ C$

Notes: (1) $T_J=25^\circ C$ to $150^\circ C$

(2) Pulse test: Pulse width $\leq 300\mu s$, Duty Cycle $\leq 2\%$

(3) Repetitive rating: Pulse width limited by max. junction temperature

ELECTRICAL CHARACTERISTICS ($T_C=25^\circ\text{C}$ unless otherwise specified)

Characteristic	Symbol	Type	Min	Typ	Max	Units	Test Conditions
Drain-Source Breakdown Voltage	BV_{DSS}	IRF630 IRF632	200	—	—	V	$V_{GS}=0V$
		IRF631 IRF633	150	—	—	V	$I_D=250\mu A$
Gate Threshold Voltage	$V_{GS(th)}$	ALL	2.0	—	4.0	V	$V_{DS}=V_{GS}$, $I_D=250\mu A$
Gate-Source Leakage Forward	I_{GSS}	ALL	—	—	100	nA	$V_{GS}=20V$
Gate-Source Leakage Reverse	I_{GSS}	ALL	—	—	-100	nA	$V_{GS}=-20V$
Zero Gate Voltage Drain Current	I_{DSS}	ALL	—	—	250	μA	$V_{DS}=\text{Max. Rating}$, $V_{GS}=0V$
			—	—	1000	μA	$V_{DS}=\text{Max. Rating} \times 0.8$, $V_{GS}=0V$, $T_C=125^\circ\text{C}$
On-State Drain-Source Current (2)	$I_{D(on)}$	IRF630 IRF631	9.0	—	—	A	$V_{DS}>I_{D(on)} \times R_{DS(on) \text{ max.}}$, $V_{GS}=10V$
		IRF632 IRF633	8.0	—	—	A	
Static Drain-Source On-State Resistance (2)	$R_{DS(on)}$	IRF630 IRF631	—	0.25	0.4	Ω	$V_{GS}=10V$, $I_D=5.0A$
		IRF632 IRF633	—	0.4	0.6	Ω	
Forward Transconductance (2)	g_{fs}	ALL	3.0	4.6	—	Ω	$V_{DS}>I_{D(on)} \times R_{DS(on) \text{ max.}}$, $I_D=5.0A$
Input Capacitance	C_{iss}	ALL	—	720	800	pF	$V_{GS}=0V$, $V_{DS}=25V$, $f=1.0\text{MHz}$
Output Capacitance	C_{oss}	ALL	—	250	450	pF	
Reverse Transfer Capacitance	C_{rss}	ALL	—	60	150	pF	
Turn-On Delay Time	$t_{d(on)}$	ALL	—	—	30	ns	$V_{DD}=0.5BV_{DSS}$, $I_D=5.0A$, $Z_\theta=15\Omega$ (MOSFET switching times are essentially independent of operating temperature.)
Rise Time	T_r	ALL	—	—	50	ns	
Turn-Off Delay Time	$t_{d(off)}$	ALL	—	—	50	ns	
Fall Time	t_f	ALL	—	—	40	ns	
Total Gate Charge (Gate-Source Plus Gate-Drain)	Q_g	ALL	—	19	30	nC	$V_{GS}=10V$, $I_D=12A$, $V_{DS}=0.8 \text{ Max. Rating}$ (Gate charge is essentially independent of operating temperature.)
Gate-Source Charge	Q_{gs}	ALL	—	5.0	—	nC	
Gate-Drain ("Miller") Charge	Q_{gd}	ALL	—	14	—	nC	

THERMAL RESISTANCE

Junction-to-Case	R_{thJC}	ALL	—	—	1.67	K/W	
Case-to-Sink	R_{thCS}	ALL	—	1.0	—	K/W	Mounting surface flat, smooth, and greased
Junction-to-Ambient	R_{thJA}	ALL	—	—	80	K/W	Free Air Operation

- Notes:** (1) $T_J=25^\circ\text{C}$ to 150°C
 (2) Pulse test: Pulse width $\leq 300\mu s$, Duty Cycle $\leq 2\%$
 (3) Repetitive rating: Pulse width limited by max. junction temperature

SOURCE-DRAIN DIODE RATINGS AND CHARACTERISTICS

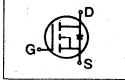
Characteristic	Symbol	Type	Min	Typ	Max	Units	Test Conditions
Continuous Source Current (Body Diode)	I_S	IRF630 IRF631	—	—	9.0	A	Modified MOSFET symbol showing the integral reverse P-N junction rectifier 
		IRF632 IRF633	—	—	8.0	A	
Pulse Source Current (Body Diode) (3)	I_{SM}	IRF630 IRF631	—	—	36	A	
		IRF632 IRF633	—	—	32	A	
		IRF630 IRF631	—	—	2.0	V	$T_C=25^\circ\text{C}$, $I_S=9.0\text{A}$, $V_{GS}=0\text{V}$
Diode Forward Voltage (2)	V_{SD}	IRF632 IRF633	—	—	1.8	V	$T_C=25^\circ\text{C}$, $I_S=8.0\text{A}$, $V_{GS}=0\text{V}$
		IRF630 IRF631	—	—	2.0	V	
Reverse Recovery Time	t_{rr}	ALL	—	450	—	ns	$T_J=150^\circ\text{C}$, $I_F=9.0\text{A}$, $dI_F/dt=100\text{A}/\mu\text{s}$

Notes: (1) $T_J=25^\circ\text{C}$ to 150°C (2) Pulse test: Pulse width $\leq 300\mu\text{s}$, Duty Cycle $\leq 2\%$
 (3) Repetitive rating: Pulse width limited by max. junction temperature

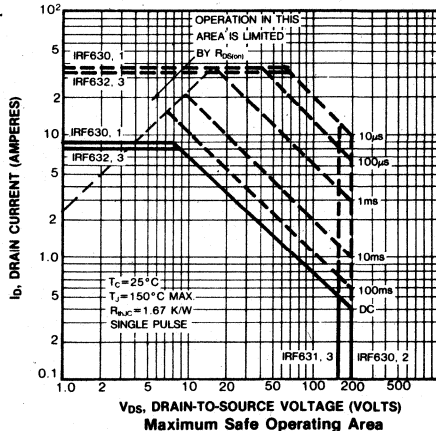
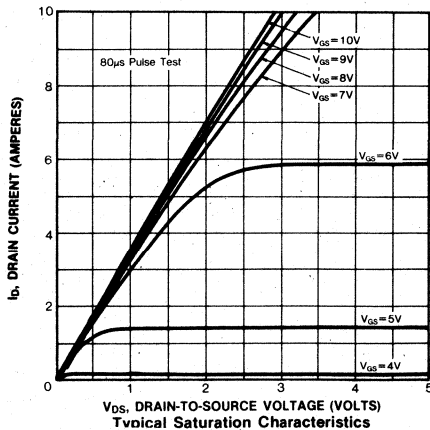
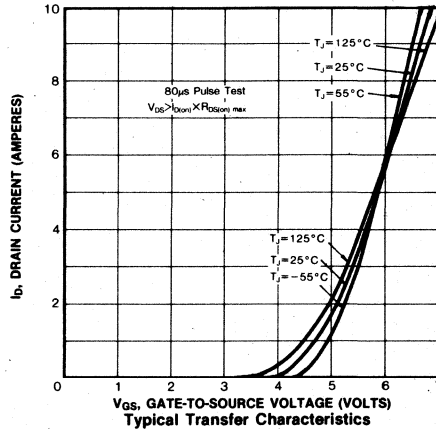
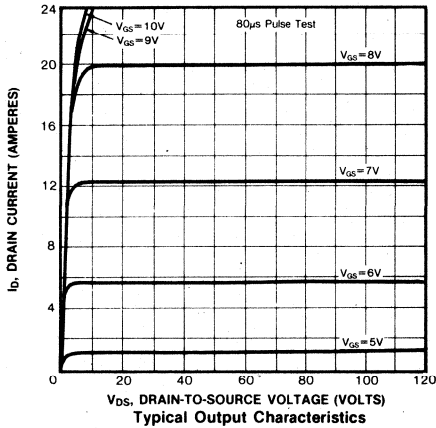

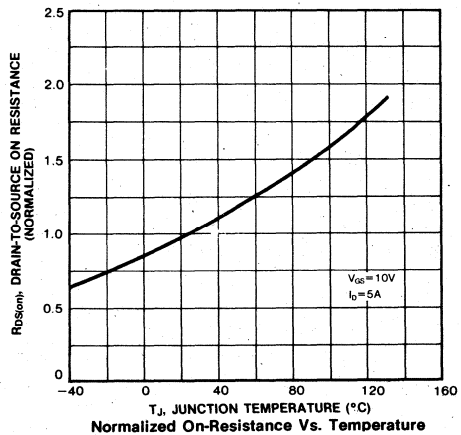
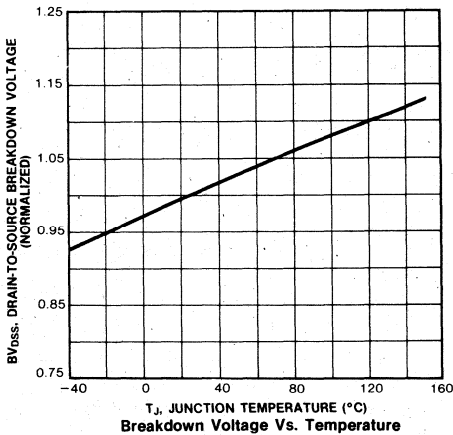
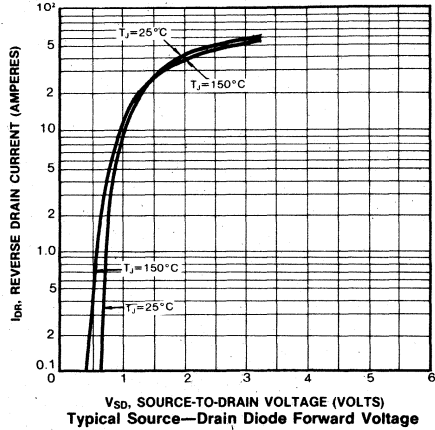
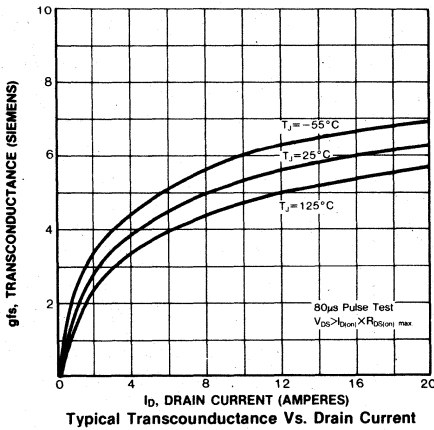
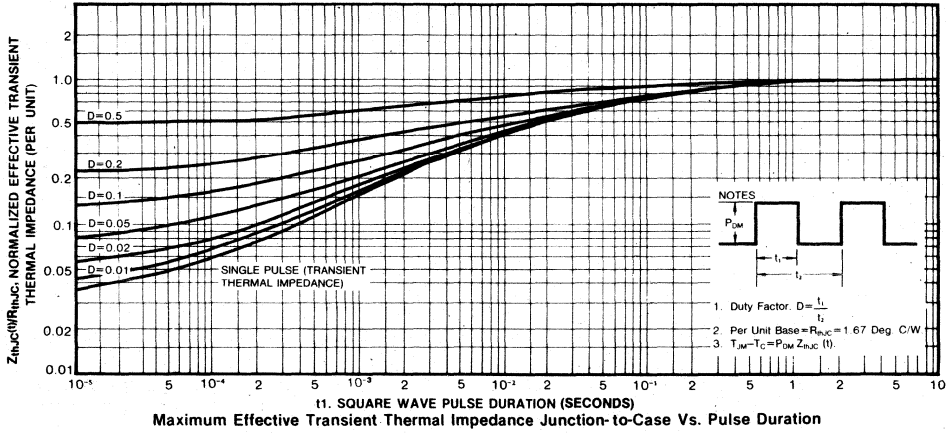

4

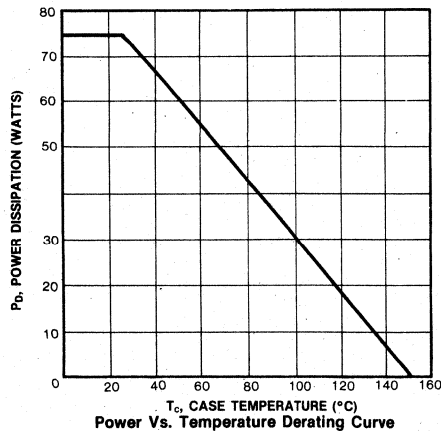
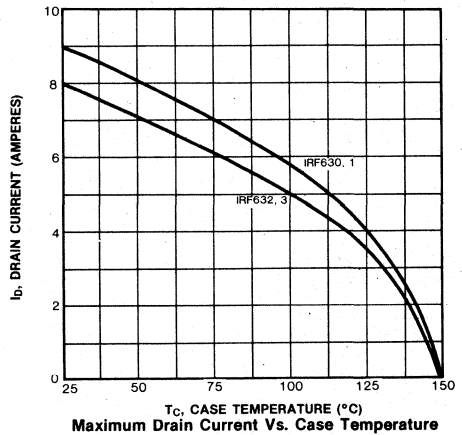
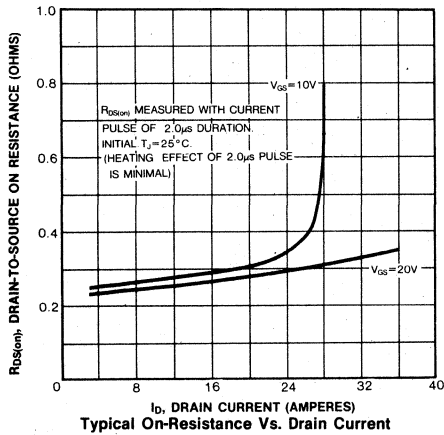
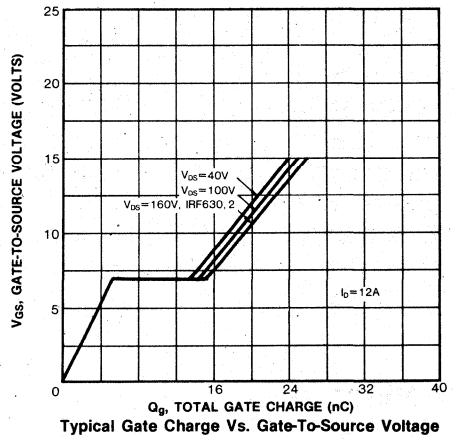
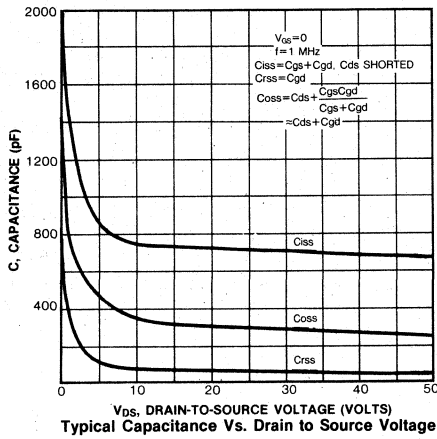

FEATURES

- Low $R_{DS(on)}$
- Improved inductive ruggedness
- Fast switching times
- Rugged polysilicon gate cell structure
- Low input capacitance
- Extended safe operating area
- Improved high temperature reliability
- TO-220 package

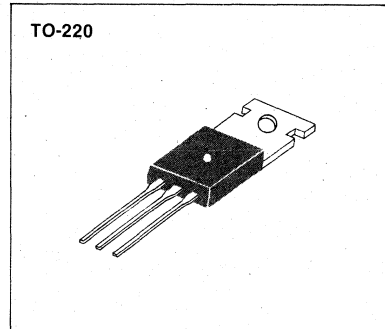

PRODUCT SUMMARY

Part Number	V_{DS}	$R_{DS(on)}$	I_D
IRF640	200V	0.18 Ω	18A
IRF641	150V	0.18 Ω	18A
IRF642	200V	0.22 Ω	16A
IRF643	150V	0.22 Ω	16A

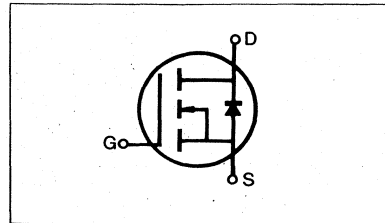

MAXIMUM RATINGS

Characteristic	Symbol	IRF640	IRF641	IRF642	IRF643	Unit
Drain-Source Voltage (1)	V_{DSS}	200	150	200	150	Vdc
Drain-Gate Voltage ($R_{GS}=1.0M\Omega$) (1)	V_{DGR}	200	150	200	150	Vdc
Gate-Source Voltage	V_{GS}	± 20				Vdc
Continuous Drain Current $T_C=25^\circ C$	I_D	18	18	16	16	Adc
Continuous Drain Current $T_C=100^\circ C$	I_D	11	11	10	10	Adc
Drain Current—Pulsed (3)	I_{DM}	72	72	64	64	Adc
Gate Current—Pulsed	I_{GM}	± 1.5				Adc
Total Power Dissipation @ $T_C=25^\circ C$ Derate above $25^\circ C$	P_D	125 1.0				Watts W/ $^\circ C$
Operating and Storage Junction Temperature Range	T_J, T_{stg}	-55 to 150				$^\circ C$
Maximum Lead Temp. for Soldering Purposes, 1/8" from case for 5 seconds	T_L	300				$^\circ C$

- Notes:** (1) $T_J=25^\circ C$ to $150^\circ C$
 (2) Pulse test: Pulse width $\leq 300\mu s$, Duty Cycle $\leq 2\%$
 (3) Repetitive rating: Pulse width limited by max. junction temperature

ELECTRICAL CHARACTERISTICS (T_C=25°C unless otherwise specified)

Characteristic	Symbol	Type	Min	Typ	Max	Units	Test Conditions
Drain-Source Breakdown Voltage	BV _{DSS}	IRF640 IRF642	200	—	—	V	V _{GS} =0V
		IRF641 IRF643	150	—	—	V	I _D =250μA
Gate Threshold Voltage	V _{GS(th)}	ALL	2.0	—	4.0	V	V _{DS} =V _{GS} , I _D =250μA
Gate-Source Leakage Forward	I _{GSS}	ALL	—	—	100	nA	V _{GS} =20V
Gate-Source Leakage Reverse	I _{GSS}	ALL	—	—	-100	nA	V _{GS} =-20V
Zero Gate Voltage Drain Current	I _{DSS}	ALL	—	—	250	μA	V _{DS} =Max. Rating, V _{GS} =0V
			—	—	1000	μA	V _{DS} =Max. Rating×0.8, V _{GS} =0V, T _C =125°C
On-State Drain-Source Current (2)	I _{D(on)}	IRF640 IRF641	18	—	—	A	V _{DS} I _{D(on)} ×R _{DS(on)} max., V _{GS} =10V
		IRF642 IRF643	16	—	—	A	
Static Drain-Source On-State Resistance (2)	R _{DS(on)}	IRF640 IRF641	—	0.13	0.18	Ω	V _{GS} =10V, I _D =10A
		IRF642 IRF643	—	0.20	0.22	Ω	
Forward Transconductance (2)	g _{fs}	ALL	6.0	9.5	—	S	V _{DS} I _{D(on)} ×R _{DS(on)} max., I _D =10A
Input Capacitance	C _{iss}	ALL	—	1200	1600	pF	V _{GS} =0V, V _{DS} =25V, f=1.0MHz
Output Capacitance	C _{oss}	ALL	—	360	750	pF	
Reverse Transfer Capacitance	C _{rss}	ALL	—	130	300	pF	
Turn-On Delay Time	t _{d(on)}	ALL	—	—	30	ns	V _{DD} =0.5BV _{DSS} , I _D =10A, Z _O =4.7Ω (MOSFET switching times are essentially independent of operating temperature.)
Rise Time	t _r	ALL	—	—	60	ns	
Turn-Off Delay Time	t _{d(off)}	ALL	—	—	80	ns	
Fall Time	t _f	ALL	—	—	60	ns	
Total Gate Charge (Gate-Source Plus Gate-Drain)	Q _g	ALL	—	44	60	nC	V _{GS} =10V, I _D =22A, V _{DS} =0.8 Max. Rating (Gate charge is essentially independent of operating temperature.)
Gate-Source Charge	Q _{gs}	ALL	—	9	—	nC	
Gate-Drain ("Miller") Charge	Q _{gd}	ALL	—	35	—	nC	

THERMAL RESISTANCE

Junction-to-Case	R _{thJC}	ALL	—	—	1.0	K/W	
Case-to-Sink	R _{thCS}	ALL	—	1.0	—	K/W	Mounting surface flat, smooth, and greased
Junction-to-Ambient	R _{thJA}	ALL	—	—	80	K/W	Free Air Operation

- Notes: (1) T_J=25°C to 150°C
 (2) Pulse test: Pulse width≤300μs, Duty Cycle≤2%
 (3) Repetitive rating: Pulse width limited by max. junction temperature

SOURCE-DRAIN DIODE RATINGS AND CHARACTERISTICS

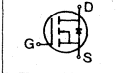
Characteristic	Symbol	Type	Min	Typ	Max	Units	Test Conditions
Continuous Source Current (Body Diode)	I_S	IRF640	—	—	18	A	Modified MOSFET symbol showing the integral reverse P-N junction rectifier 
		IRF641	—	—	16	A	
		IRF642	—	—	16	A	
Pulse Source Current (Body Diode) (3)	I_{SM}	IRF640	—	—	72	A	
		IRF641	—	—	72	A	
		IRF642	—	—	64	A	
Diode Forward Voltage (2)	V_{SD}	IRF640	—	—	2.0	V	$T_C=25^\circ\text{C}$, $I_S=18\text{A}$, $V_{GS}=0\text{V}$
		IRF641	—	—	2.0	V	$T_C=25^\circ\text{C}$, $I_S=16\text{A}$, $V_{GS}=0\text{V}$
		IRF642	—	—	1.9	V	$T_C=25^\circ\text{C}$, $I_S=16\text{A}$, $V_{GS}=0\text{V}$
Reverse Recovery Time	t_{rr}	ALL	—	650	—	ns	$T_J=150^\circ\text{C}$, $I_F=18\text{A}$, $dI_F/dt=100\text{A}/\mu\text{s}$

Notes: (1) $T_J=25^\circ\text{C}$ to 150°C (2) Pulse test: Pulse width $\leq 300\mu\text{s}$, Duty Cycle $\leq 2\%$
 (3) Repetitive rating: Pulse width limited by max. junction temperature

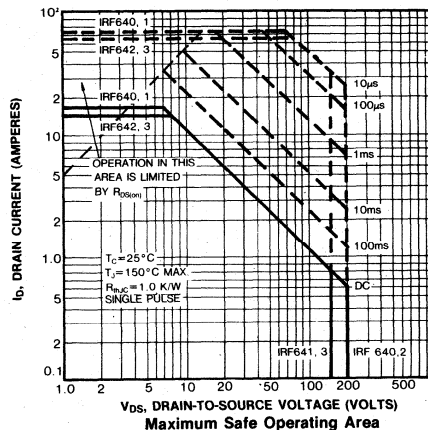
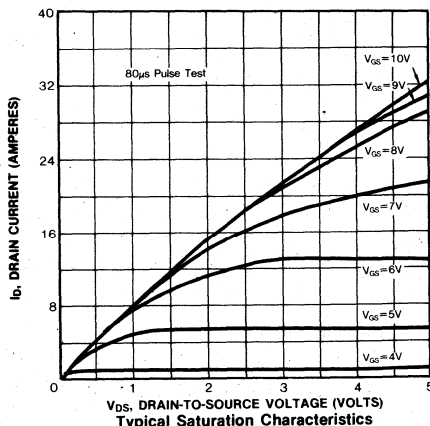
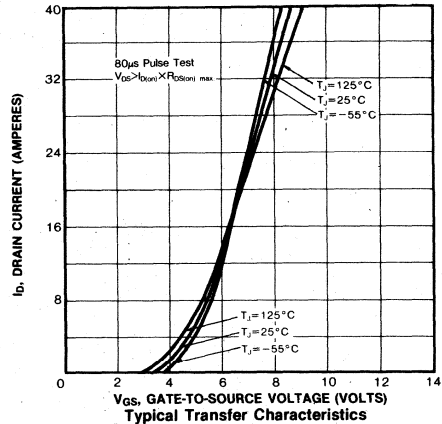
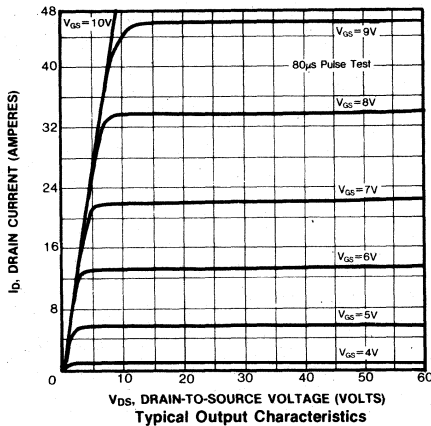

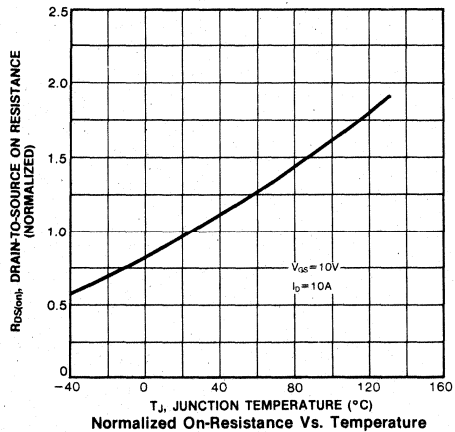
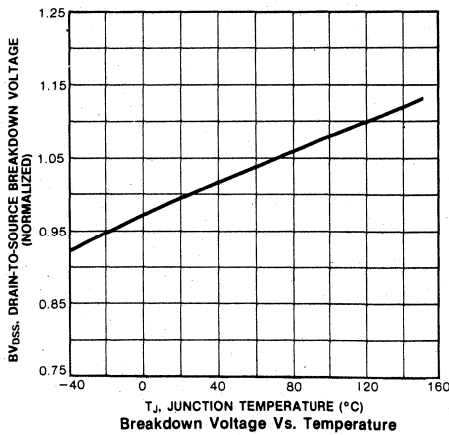
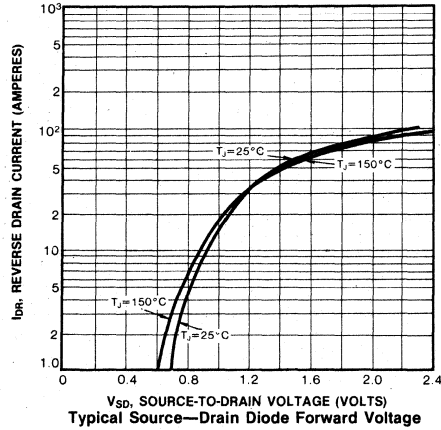
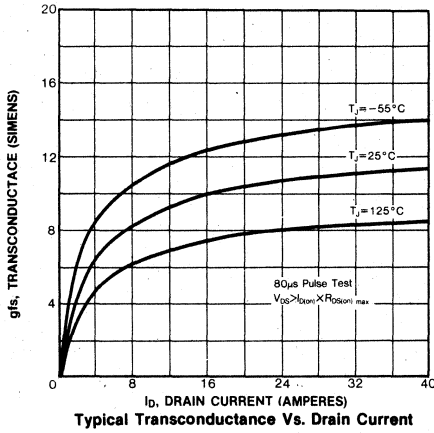
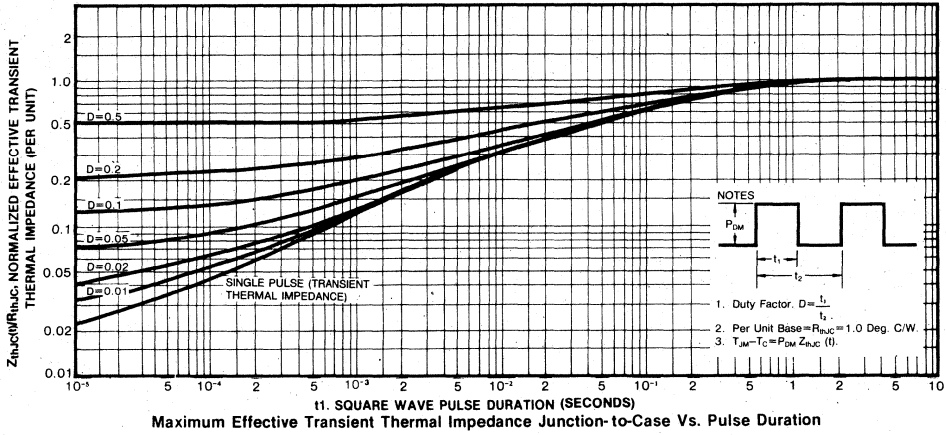

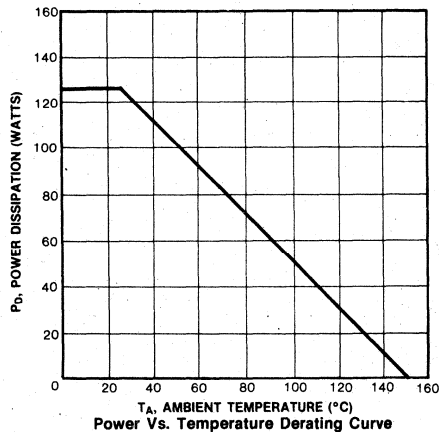
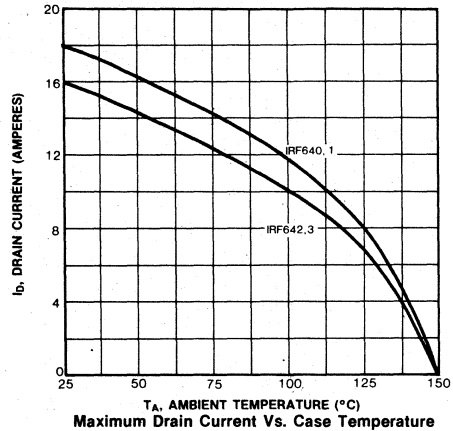
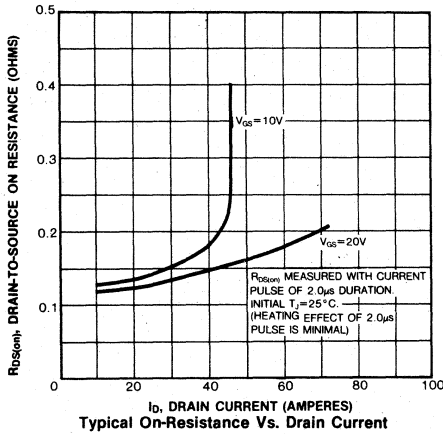
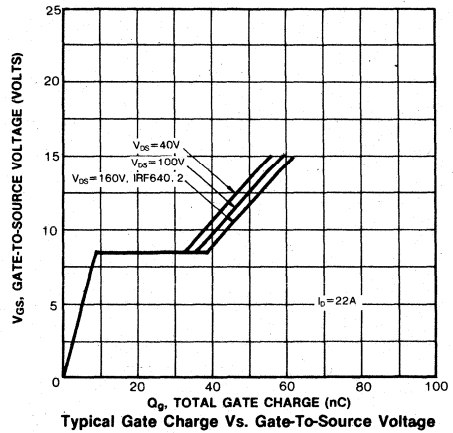
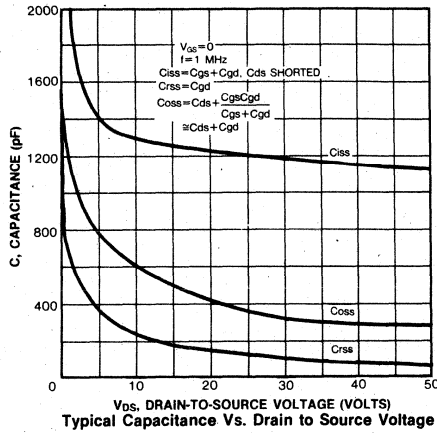

FEATURES

- Low $R_{DS(on)}$
- Improved inductive ruggedness
- Fast switching times
- Rugged polysilicon gate cell structure
- Low input capacitance
- Extended safe operating area
- Improved high temperature reliability
- TO-220 package

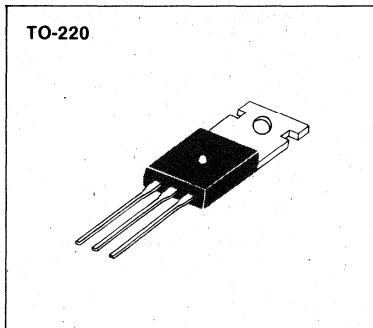

PRODUCT SUMMARY

Part Number	V_{DS}	$R_{DS(on)}$	I_D
IRF710	400V	3.6 Ω	1.5A
IRF711	350V	3.6 Ω	1.5A
IRF712	400V	5.0 Ω	1.3A
IRF713	350V	5.0 Ω	1.3A

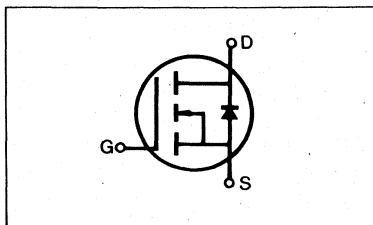

MAXIMUM RATINGS

Characteristic	Symbol	IRF710	IRF711	IRF712	IRF713	Unit
Drain-Source Voltage (1)	V_{DSS}	400	350	400	350	Vdc
Drain-Gate Voltage ($R_{GS}=1.0M\Omega$) (1)	V_{DGR}	400	350	400	350	Vdc
Gate-Source Voltage	V_{GS}	± 20				Vdc
Continuous Drain Current $T_C=25^\circ C$	I_D	1.5	1.5	1.3	1.3	Adc
Continuous Drain Current $T_C=100^\circ C$	I_D	1.0	1.0	0.8	0.8	Adc
Drain Current—Pulsed (3)	I_{DM}	6.0	6.0	5.0	5.0	Adc
Gate Current—Pulsed	I_{GM}	± 1.5				Adc
Total Power Dissipation @ $T_C=25^\circ C$ Derate above $25^\circ C$	P_D	20 0.16				Watts W/ $^\circ C$
Operating and Storage Junction Temperature Range	T_J, T_{stg}	-55 to 150				$^\circ C$
Maximum Lead Temp. for Soldering Purposes, 1/8" from case for 5 seconds	T_L	300				$^\circ C$

- Notes:** (1) $T_J=25^\circ C$ to $150^\circ C$
 (2) Pulse test: Pulse width $\leq 300\mu s$, Duty Cycle $\leq 2\%$
 (3) Repetitive rating: Pulse width limited by max. junction temperature

ELECTRICAL CHARACTERISTICS (T_C=25°C unless otherwise specified)

Characteristic	Symbol	Type	Min	Typ	Max	Units	Test Conditions
Drain-Source Breakdown Voltage	BV _{DSS}	IRF710 IRF712	400	—	—	V	V _{GS} =0V
		IRF711 IRF713	350	—	—	V	I _D =250μA
Gate Threshold Voltage	V _{GS(th)}	ALL	2.0	—	4.0	V	V _{DS} =V _{GS} , I _D =250μA
Gate-Source Leakage Forward	I _{GSS}	ALL	—	—	100	nA	V _{GS} =20V
Gate-Source Leakage Reverse	I _{GSS}	ALL	—	—	-100	nA	V _{GS} =-20V
Zero Gate Voltage Drain Current	I _{DSS}	ALL	—	—	250	μA	V _{DS} =Max. Rating, V _{GS} =0V
			—	—	1000	μA	V _{DS} =Max. Rating×0.8, V _{GS} =0V, T _C =125°C
On-State Drain-Source Current (2)	I _{D(on)}	IRF710 IRF711	1.5	—	—	A	V _{DS} >I _{D(on)} ×R _{DS(on) max.} , V _{GS} =10V
		IRF712 IRF713	1.3	—	—	A	
Static Drain-Source On-State Resistance (2)	R _{DS(on)}	IRF710 IRF711	—	3.2	3.6	Ω	V _{GS} =10V, I _D =0.8A
		IRF712 IRF713	—	3.5	5.0	Ω	
Forward Transconductance (2)	g _{fs}	ALL	0.5	1.0	—	Ω	V _{DS} >I _{D(on)} ×R _{DS(on) max.} , I _D =0.8A
Input Capacitance	C _{iss}	ALL	—	140	150	pF	V _{GS} =0V, V _{DS} =25V, f=1.0MHz see fig. 10
Output Capacitance	C _{oss}	ALL	—	35	50	pF	
Reverse Transfer Capacitance	C _{rss}	ALL	—	7.0	15	pF	
Turn-On Delay Time	t _{d(on)}	ALL	—	—	10	ns	V _{DD} =0.5BV _{DSS} , I _D =0.8A, Z _O =50Ω, (MOSFET switching times are essentially independent of operating temperature.)
Rise Time	t _r	ALL	—	—	20	ns	
Turn-Off Delay Time	t _{d(off)}	ALL	—	—	10	ns	
Fall Time	t _f	ALL	—	—	15	ns	
Total Gate Charge (Gate-Source Plus Gate-Drain)	Q _g	ALL	—	6.0	7.5	nC	V _{GS} =10V, I _D =2.0A, V _{DS} =0.8 Max. Rating (Gate charge is essentially independent of operating temperature.)
Gate-Source Charge	Q _{gs}	ALL	—	1.5	—	nC	
Gate-Drain ("Miller") Charge	Q _{gd}	ALL	—	4.5	—	nC	

THERMAL RESISTANCE

Junction-to-Case	R _{thJC}	ALL	—	—	6.4	K/W	
Case-to-Sink	R _{thCS}	ALL	—	1.0	—	K/W	Mounting surface flat, smooth, and greased
Junction-to-Ambient	R _{thJA}	ALL	—	—	80	K/W	Free Air Operation

- Notes:** (1) T_J=25°C to 150°C
 (2) Pulse test: Pulse width≤300μs, Duty Cycle≤2%
 (3) Repetitive rating: Pulse width limited by max. junction temperature

SOURCE-DRAIN DIODE RATINGS AND CHARACTERISTICS

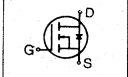
Characteristic	Symbol	Type	Min	Typ	Max	Units	Test Conditions
Continuous Source Current (Body Diode)	I_S	IRF710 IRF711	—	—	1.5	A	Modified MOSFET symbol showing the integral reverse P-N junction rectifier 
		IRF712 IRF713	—	—	1.3	A	
Pulse Source Current (Body Diode) (3)	I_{SM}	IRF710 IRF711	—	—	6.0	A	
		IRF712 IRF713	—	—	5.0	A	
Diode Forward Voltage (2)	V_{SD}	IRF710 IRF711	—	—	1.6	V	$T_C=25^\circ\text{C}$, $I_S=1.5\text{A}$, $V_{GS}=0\text{V}$
		IRF712 IRF713	—	—	1.5	V	$T_C=25^\circ\text{C}$, $I_S=1.3\text{A}$, $V_{GS}=0\text{V}$
Reverse Recovery Time	t_{rr}	ALL	—	380	—	ns	$T_J=150^\circ\text{C}$, $I_F=1.5\text{A}$, $dI_F/dt=100\text{A}/\mu\text{s}$

Notes: (1) $T_J=25^\circ\text{C}$ to 150°C (2) Pulse test: Pulse width $\leq 300\mu\text{s}$, Duty Cycle $\leq 2\%$
 (3) Repetitive rating: Pulse width limited by max. junction temperature

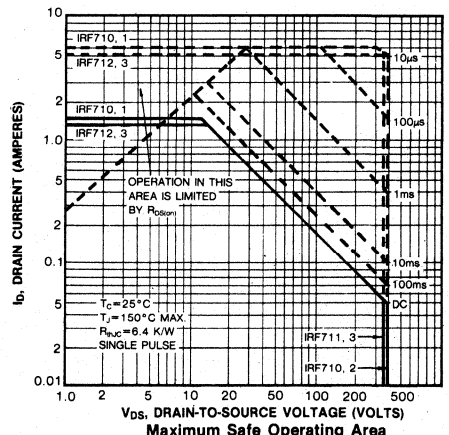
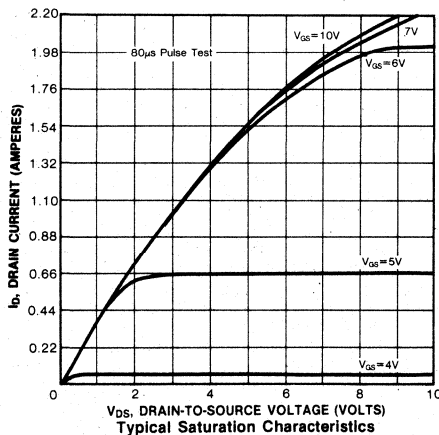
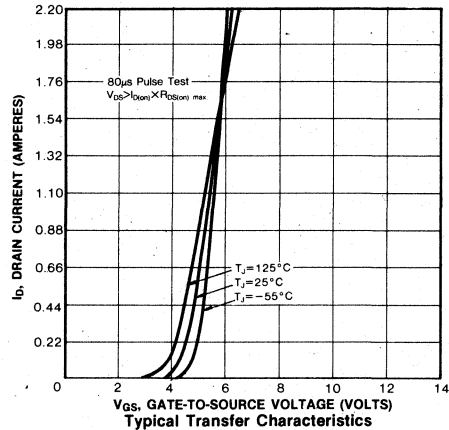
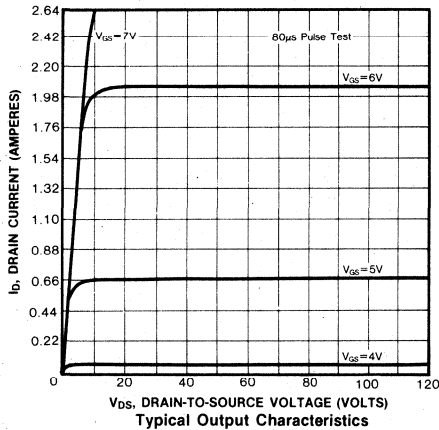

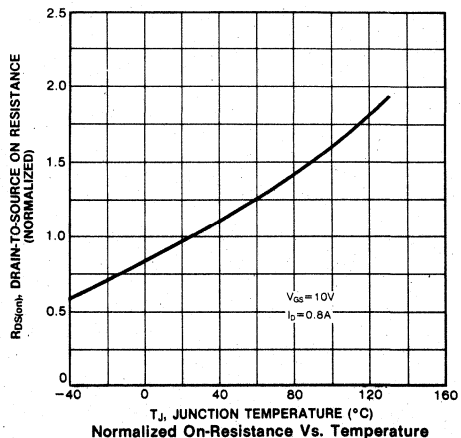
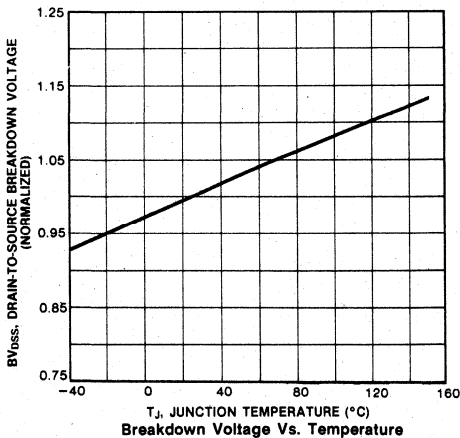
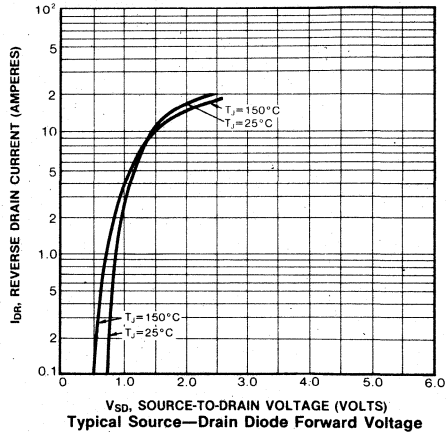
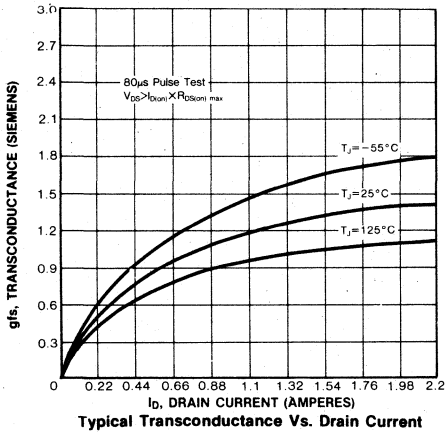
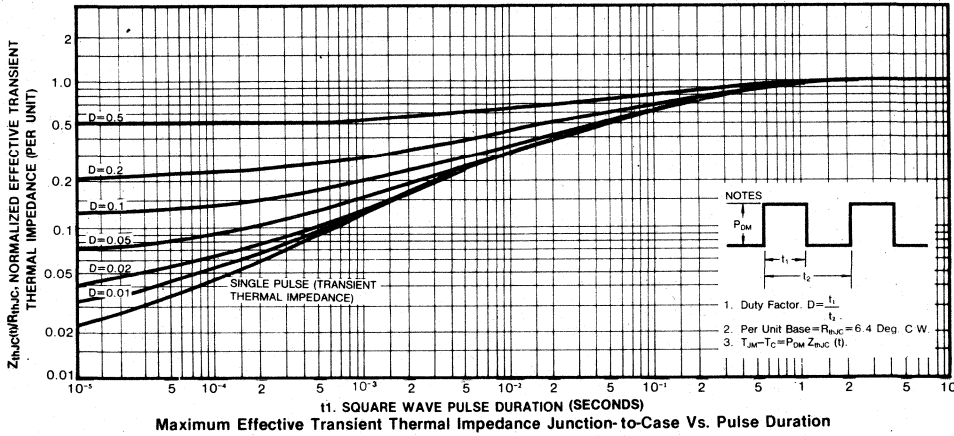

4

IRF710/711/712/713

N-CHANNEL POWER MOSFETS

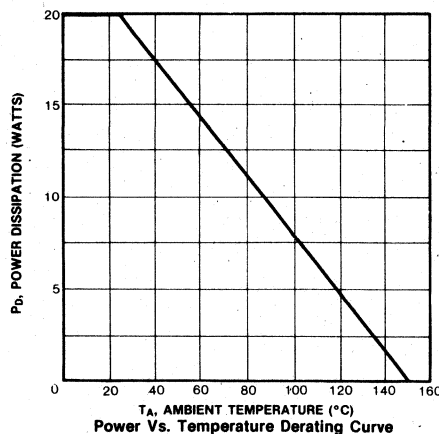
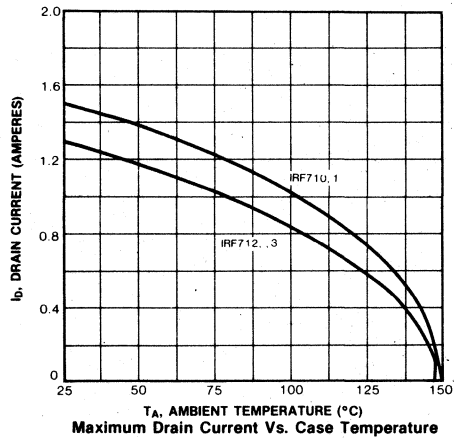
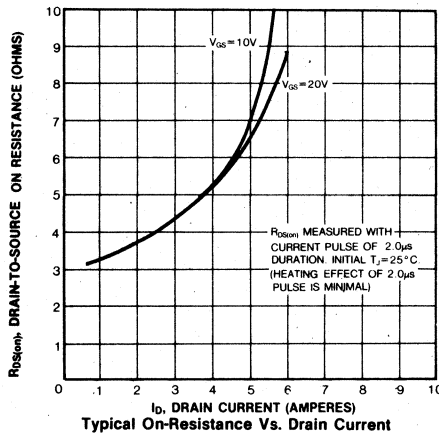
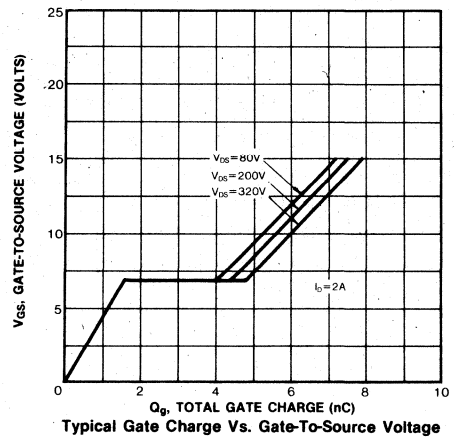
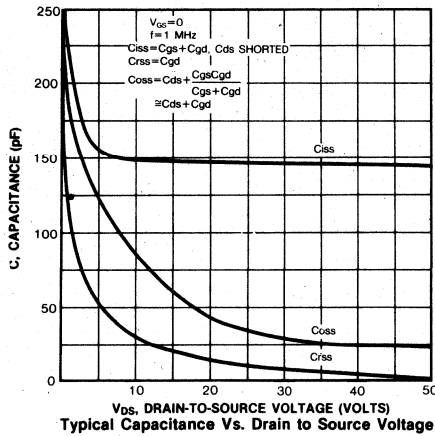

FEATURES

- Low $R_{DS(on)}$
- Improved inductive ruggedness
- Fast switching times
- Rugged polysilicon gate cell structure
- Low input capacitance
- Extended safe operating area
- Improved high temperature reliability
- TO-220 package

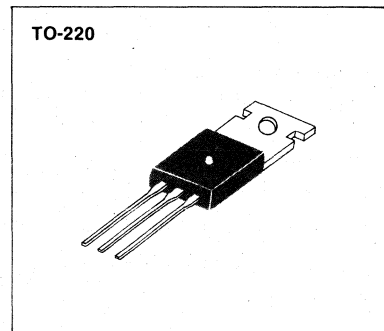

PRODUCT SUMMARY

Part Number	V_{DS}	$R_{DS(on)}$	I_D
IRF720	400V	1.8Ω	3.0A
IRF721	350V	1.8Ω	3.0A
IRF722	400V	2.5Ω	2.5A
IRF723	350V	2.5Ω	2.5A

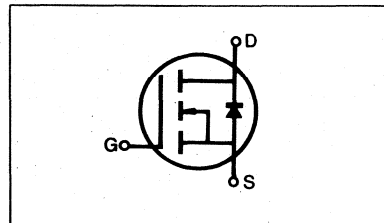

MAXIMUM RATINGS

Characteristic	Symbol	IRF720	IRF721	IRF722	IRF723	Unit
Drain-Source Voltage (1)	V_{DSS}	400	350	400	350	Vdc
Drain-Gate Voltage ($R_{GS}=1.0M\Omega$) (1)	V_{DGR}	400	350	400	350	Vdc
Gate-Source Voltage	V_{GS}	±20				Vdc
Continuous Drain Current $T_C=25^\circ C$	I_D	3.0	3.0	2.5	2.5	Adc
Continuous Drain Current $T_C=100^\circ C$	I_D	2.0	2.0	1.5	1.5	Adc
Drain Current—Pulsed (3)	I_{DM}	12	12	10	10	Adc
Gate Current—Pulsed	I_{GM}	±1.5				Adc
Total Power Dissipation @ $T_C=25^\circ C$ Derate above $25^\circ C$	P_D	40 0.32				Watts W/°C
Operating and Storage Junction Temperature Range	T_J, T_{stg}	-55 to 150				°C
Maximum Lead Temp. for Soldering Purposes, 1/8" from case for 5 seconds	T_L	300				°C

- Notes: (1) $T_J=25^\circ C$ to $150^\circ C$
 (2) Pulse test: Pulse width $\leq 300\mu s$, Duty Cycle $\leq 2\%$
 (3) Repetitive rating: Pulse width limited by max. junction temperature

ELECTRICAL CHARACTERISTICS (T_C=25°C unless otherwise specified)

Characteristic	Symbol	Type	Min	Typ	Max	Units	Test Conditions
Drain-Source Breakdown Voltage	BV _{DSS}	IRF720 IRF722	400	—	—	V	V _{GS} =0V
		IRF721 IRF723	350	—	—	V	I _D =250μA
Gate Threshold Voltage	V _{GS(th)}	ALL	2.0	—	4.0	V	V _{DS} =V _{GS} , I _D =250μA
Gate-Source Leakage Forward	I _{GSS}	ALL	—	—	100	nA	V _{GS} =20V
Gate-Source Leakage Reverse	I _{GSS}	ALL	—	—	-100	nA	V _{GS} =-20V
Zero Gate Voltage Drain Current	I _{DSS}	ALL	—	—	250	μA	V _{DS} =Max. Rating, V _{GS} =0V
			—	—	1000	μA	V _{DS} =Max. Rating×0.8, V _{GS} =0V, T _C =125°C
On-State Drain-Source Current (2)	I _{D(on)}	IRF720 IRF721	3.0	—	—	A	V _{DS} >I _{D(on)} ×R _{DS(on)} max., V _{GS} =10V
		IRF722 IRF723	2.5	—	—	A	
Static Drain-Source On-State Resistance (2)	R _{DS(on)}	IRF720 IRF721	—	1.4	1.8	Ω	V _{GS} =10V, I _D =1.5A
		IRF722 IRF723	—	1.7	2.5	Ω	
Forward Transconductance (2)	g _{fs}	ALL	1.0	2.2	—	∅	V _{DS} >I _{D(on)} ×R _{DS(on)} max., I _D =1.5A
Input Capacitance	C _{iss}	ALL	—	460	600	pF	V _{GS} =0V, V _{DS} =25V, f=1.0MHz see fig. 10
Output Capacitance	C _{oss}	ALL	—	90	200	pF	
Reverse Transfer Capacitance	C _{rss}	ALL	—	30	40	pF	
Turn-On Delay Time	t _{d(on)}	ALL	—	—	40	ns	V _{DD} =0.5BV _{DSS} , I _D =1.5A, Z _O =50Ω, (MOSFET switching times are essentially independent of operating temperature.)
Rise Time	t _r	ALL	—	—	50	ns	
Turn-Off Delay Time	t _{d(off)}	ALL	—	—	100	ns	
Fall Time	t _f	ALL	—	—	50	ns	
Total Gate Charge (Gate-Source Plus Gate-Drain)	Q _g	ALL	—	12.5	15	nC	V _{GS} =10V, I _D =4.0A, V _{DS} =0.8 Max. Rating (Gate charge is essentially independent of operating temperature.)
Gate-Source Charge	Q _{gs}	ALL	—	2.8	—	nC	
Gate-Drain ("Miller") Charge	Q _{gd}	ALL	—	9.7	—	nC	

THERMAL RESISTANCE

Junction-to-Case	R _{thJC}	ALL	—	—	3.12	K/W	
Case-to-Sink	R _{thCS}	ALL	—	1.0	—	K/W	Mounting surface flat, smooth, and greased
Junction-to-Ambient	R _{thJA}	ALL	—	—	80	K/W	Free Air Operation

Notes: (1) T_J=25°C to 150°C

(2) Pulse test: Pulse width≤300μs, Duty Cycle≤2%

(3) Repetitive rating: Pulse width limited by max. junction temperature

SOURCE-DRAIN DIODE RATINGS AND CHARACTERISTICS

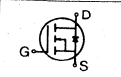
Characteristic	Symbol	Type	Min	Typ	Max	Units	Test Conditions
Continuous Source Current (Body Diode)	I _S	IRF720 IRF721	—	—	3.0	A	Modified MOSFET symbol showing the integral reverse P-N junction rectifier 
		IRF722 IRF723	—	—	2.5	A	
Pulse Source Current (Body Diode) (3)	I _{SM}	IRF720 IRF721	—	—	12	A	
		IRF722 IRF723	—	—	10	A	
Diode Forward Voltage (2)	V _{SD}	IRF720 IRF721	—	—	1.6	V	T _C =25°C, I _S =3.0A, V _{GS} =0V
		IRF722 IRF723	—	—	1.5	V	T _C =25°C, I _S =2.5A, V _{GS} =0V
Reverse Recovery Time	t _{rr}	ALL	—	450	—	ns	T _J =150°C, I _F =3.0A, dI _F /dt=100A/μs

Notes: (1) T_J=25°C to 150°C (2) Pulse test: Pulse width ≤ 300μs, Duty Cycle ≤ 2%
 (3) Repetitive rating: Pulse width limited by max. junction temperature

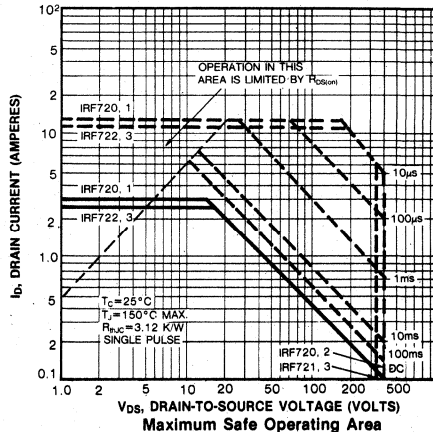
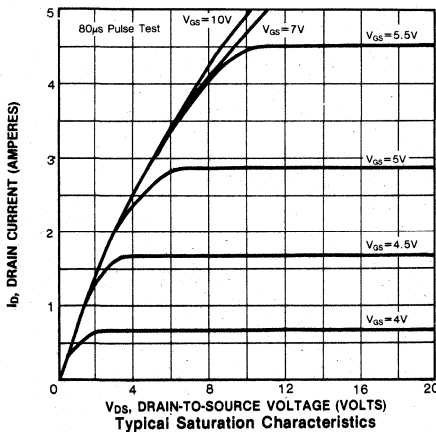
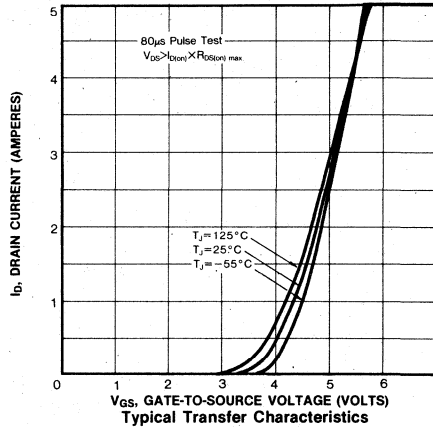
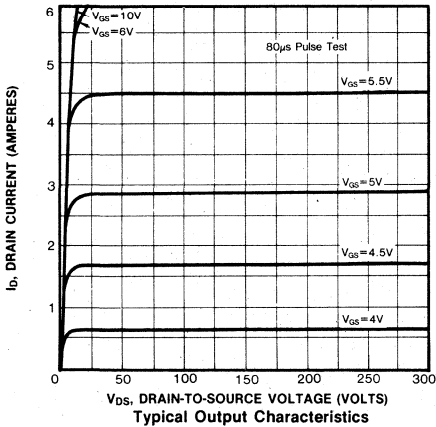

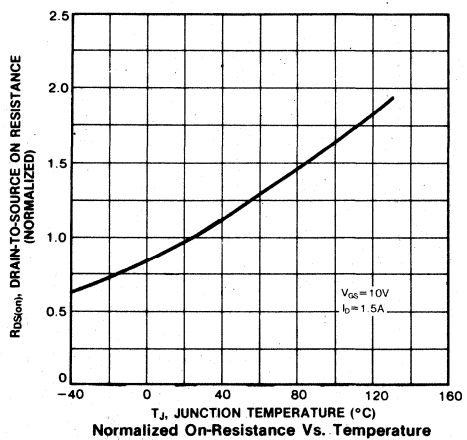
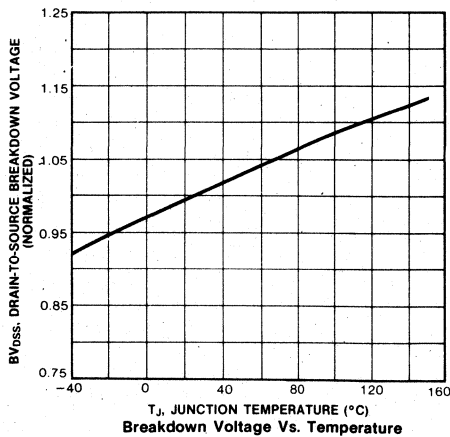
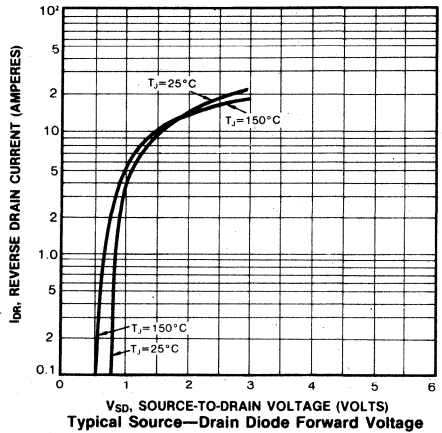
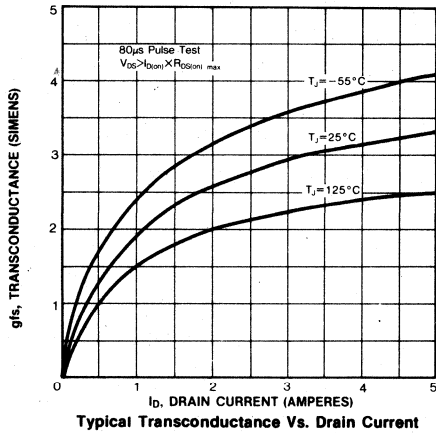
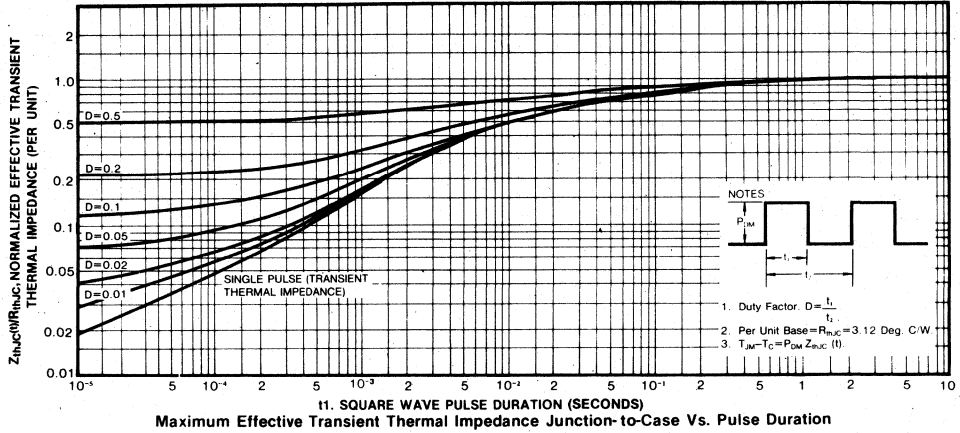

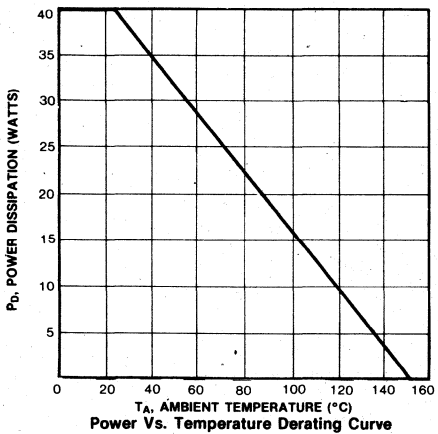
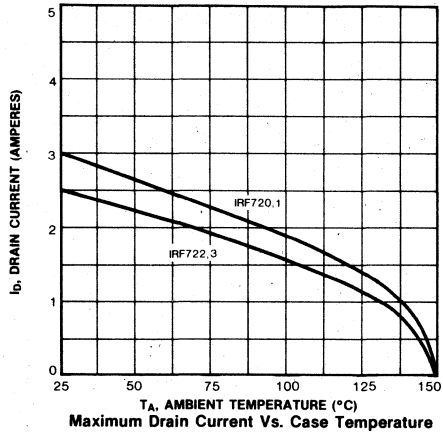
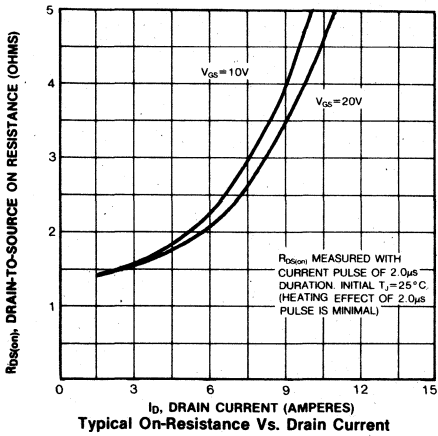
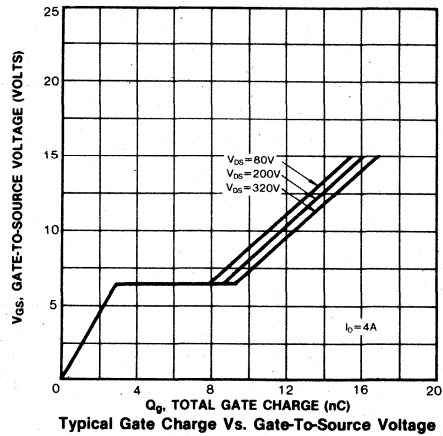
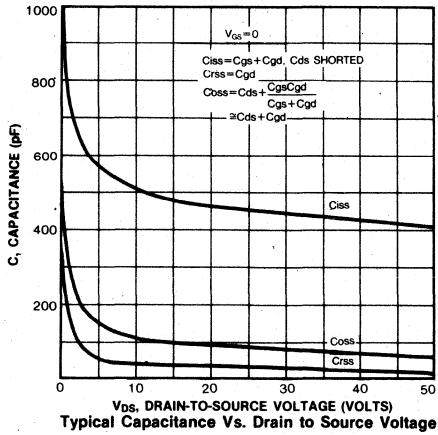

4

FEATURES

- Low $R_{DS(on)}$
- Improved inductive ruggedness
- Fast switching times
- Rugged polysilicon gate cell structure
- Low input capacitance
- Extended safe operating area
- Improved high temperature reliability
- TO-220 package

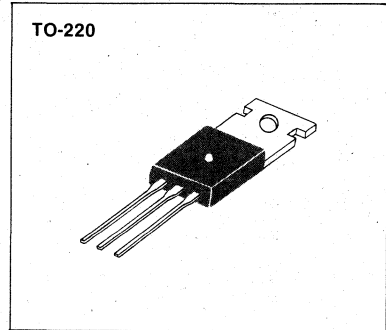

PRODUCT SUMMARY

Part Number	V_{DS}	$R_{DS(on)}$	I_D
IRF730	400V	1.0Ω	5.5A
IRF731	350V	1.0Ω	5.5A
IRF732	400V	1.5Ω	4.5A
IRF733	350V	1.5Ω	4.5A

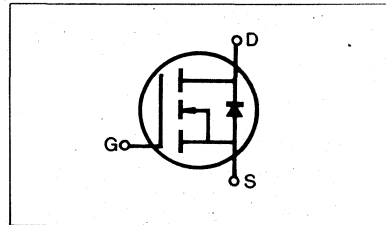

MAXIMUM RATINGS

Characteristic	Symbol	IRF730	IRF731	IRF732	IRF733	Unit
Drain-Source Voltage (1)	V_{DSS}	400	350	400	350	Vdc
Drain-Gate Voltage ($R_{GS}=1.0M\Omega$) (1)	V_{DGR}	400	350	400	350	Vdc
Gate-Source Voltage	V_{GS}	±20				Vdc
Continuous Drain Current $T_C=25^\circ C$	I_D	5.5	5.5	4.5	4.5	Adc
Continuous Drain Current $T_C=100^\circ C$	I_D	3.5	3.5	3.0	3.0	Adc
Drain Current—Pulsed (3)	I_{DM}	22	22	18	18	Adc
Gate Current—Pulsed	I_{GM}	±1.5				Adc
Total Power Dissipation @ $T_C=25^\circ C$ Derate above $25^\circ C$	P_D	75 0.6				Watts W/°C
Operating and Storage Junction Temperature Range	T_J, T_{stg}	-55 to 150				°C
Maximum Lead Temp. for Soldering Purposes, 1/8" from case for 5 seconds	T_L	300				°C

- Notes:** (1) $T_J=25^\circ C$ to $150^\circ C$
 (2) Pulse test: Pulse width $\leq 300\mu s$, Duty Cycle $\leq 2\%$
 (3) Repetitive rating: Pulse width limited by max. junction temperature

ELECTRICAL CHARACTERISTICS (T_C=25°C unless otherwise specified)

Characteristic	Symbol	Type	Min	Typ	Max	Units	Test Conditions
Drain-Source Breakdown Voltage	BV _{DSS}	IRF730	400	—	—	V	V _{GS} =0V
		IRF732					
		IRF731	350	—	—	V	I _D =250μA
IRF733							
Gate Threshold Voltage	V _{GS(th)}	ALL	2.0	—	4.0	V	V _{DS} =V _{GS} , I _D =250μA
Gate-Source Leakage Forward	I _{GSS}	ALL	—	—	100	nA	V _{GS} =20V
Gate-Source Leakage Reverse	I _{GSS}	ALL	—	—	-100	nA	V _{GS} =-20V
Zero Gate Voltage Drain Current	I _{DSS}	ALL	—	—	250	μA	V _{DS} =Max. Rating, V _{GS} =0V
			—	—	1000	μA	V _{DS} =Max. Rating×0.8, V _{GS} =0V, T _C =125°C
On-State Drain-Source Current (2)	I _{D(on)}	IRF730	5.5	—	—	A	V _{DS} >I _{D(on)} ×R _{DS(on) max.} , V _{GS} =10V
		IRF731					
IRF732	4.5	—	—	A			
IRF733							
Static Drain-Source On-State Resistance (2)	R _{DS(on)}	IRF730	—	0.8	1.0	Ω	V _{GS} =10V, I _D =3.0A
		IRF731					
IRF732	—	1.0	1.5	Ω			
IRF733							
Forward Transconductance (2)	g _{fs}	ALL	3.0	4.4	—	♯	V _{DS} >I _{D(on)} ×R _{DS(on) max.} , I _D =3.0A
Input Capacitance	C _{iss}	ALL	—	730	800	pF	V _{GS} =0V, V _{DS} =25V, f=1.0MHz
Output Capacitance	C _{oss}	ALL	—	100	300	pF	
Reverse Transfer Capacitance	C _{rss}	ALL	—	50	80	pF	
Turn-On Delay Time	t _{d(on)}	ALL	—	—	30	ns	V _{DD} =0.5BV _{DSS} , I _D =3.0A, Z _O =15Ω (MOSFET switching times are essentially independent of operating temperature.)
Rise Time	t _r	ALL	—	—	35	ns	
Turn-Off Delay Time	t _{d(off)}	ALL	—	—	55	ns	
Fall Time	t _f	ALL	—	—	35	ns	
Total Gate Charge (Gate-Source Plus Gate-Drain)	Q _g	ALL	—	18	30	nC	
Gate-Source Charge	Q _{gs}	ALL	—	4.0	—	nC	V _{GS} =10V, I _D =7.0A, V _{DS} =0.8 Max. Rating (Gate charge is essentially independent of operating temperature.)
Gate-Drain ("Miller") Charge	Q _{gd}	ALL	—	14	—	nC	

THERMAL RESISTANCE

Junction-to-Case	R _{thJC}	ALL	—	—	1.67	K/W	
Case-to-Sink	R _{thCS}	ALL	—	1.0	—	K/W	Mounting surface flat, smooth, and greased
Junction-to-Ambient	R _{thJA}	ALL	—	—	80	K/W	Free Air Operation

- Notes:** (1) T_J=25°C to 150°C
 (2) Pulse test: Pulse width≤300μs, Duty Cycle≤2%
 (3) Repetitive rating: Pulse width limited by max. junction temperature

SOURCE-DRAIN DIODE RATINGS AND CHARACTERISTICS

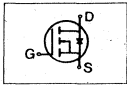
Characteristic	Symbol	Type	Min	Typ	Max	Units	Test Conditions
Continuous Source Current (Body Diode)	I_S	IRF730 IRF731	—	—	5.5	A	Modified MOSFET symbol showing the integral reverse P-N junction rectifier 
		IRF732 IRF733	—	—	4.5	A	
Pulse Source Current (Body Diode) (3)	I_{SM}	IRF730 IRF731	—	—	22	A	
		IRF732 IRF733	—	—	18	A	
Diode Forward Voltage (2)	V_{SD}	IRF730 IRF731	—	—	1.6	V	$T_C=25^\circ\text{C}$, $I_S=5.5\text{A}$, $V_{GS}=0\text{V}$
		IRF732 IRF733	—	—	1.5	V	$T_C=25^\circ\text{C}$, $I_S=4.5\text{A}$, $V_{GS}=0\text{V}$
Reverse Recovery Time	t_{rr}	ALL	—	600	—	ns	$T_J=150^\circ\text{C}$, $I_F=5.5\text{A}$, $dI_F/dt=100\text{A}/\mu\text{s}$

Notes: (1) $T_J=25^\circ\text{C}$ to 150°C (2) Pulse test: Pulse width $\leq 300\mu\text{s}$, Duty Cycle $\leq 2\%$
 (3) Repetitive rating: Pulse width limited by max. junction temperature

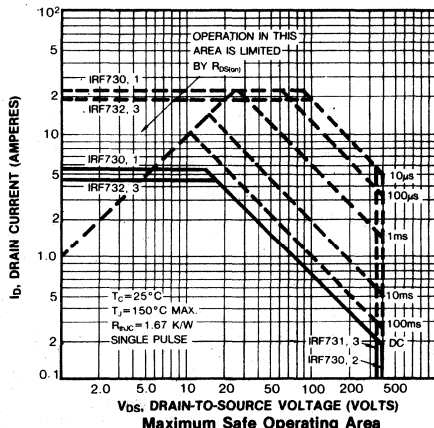
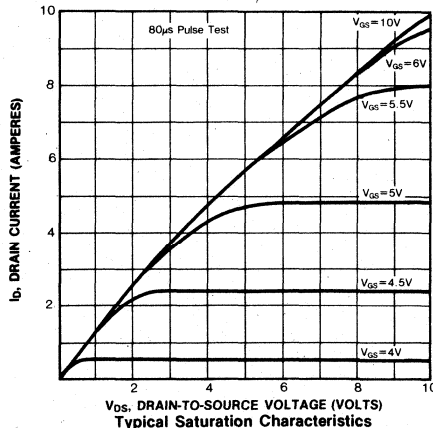
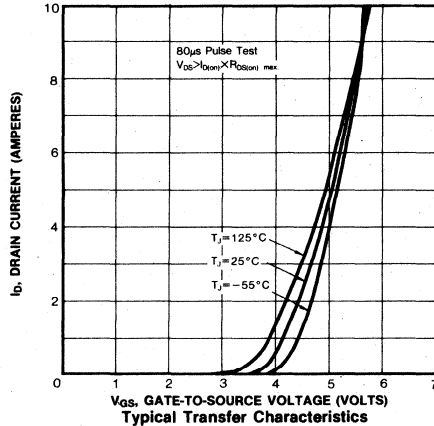
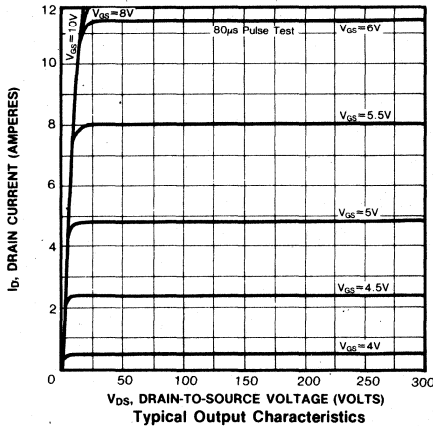

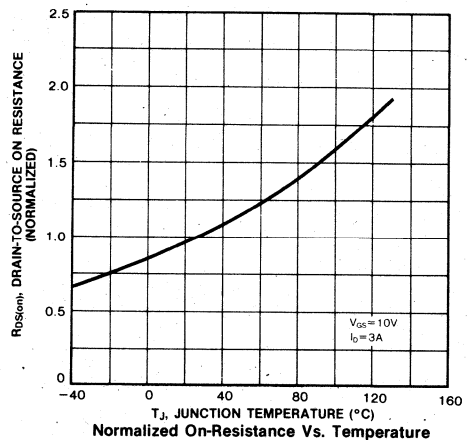
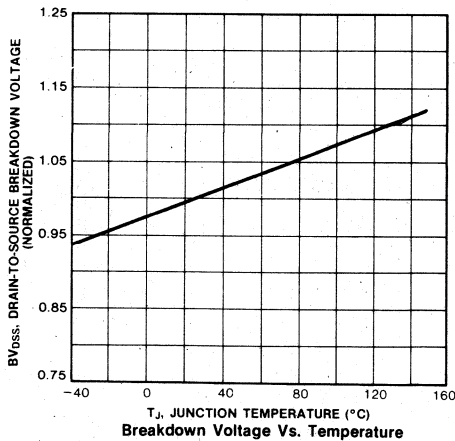
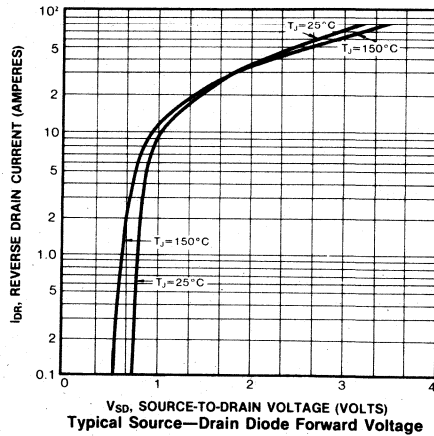
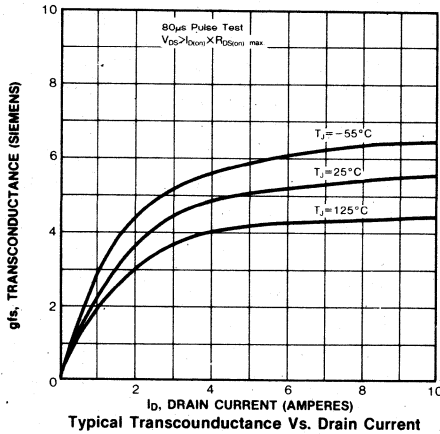
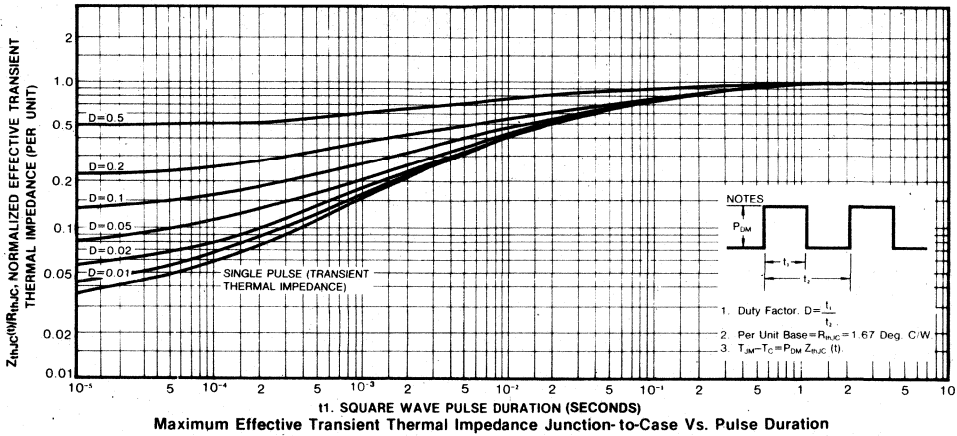

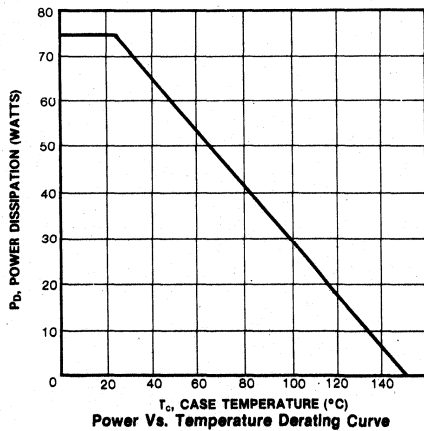
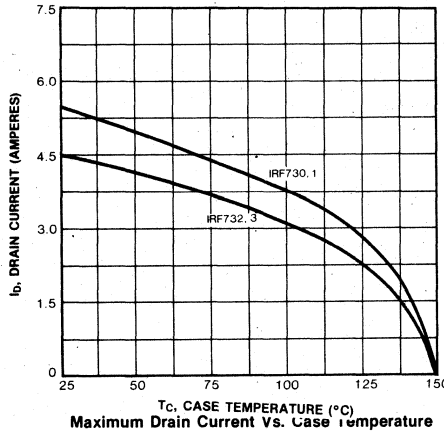
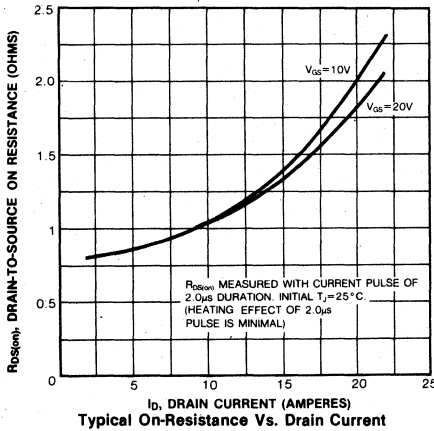
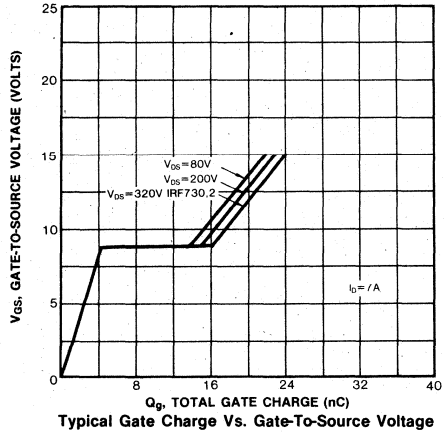
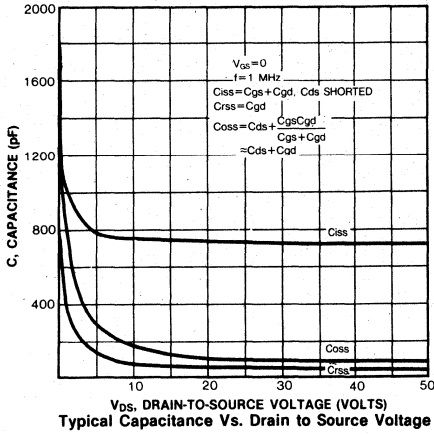

FEATURES

- Low $R_{DS(on)}$
- Improved inductive ruggedness
- Fast switching times
- Rugged polysilicon gate cell structure
- Low input capacitance
- Extended safe operating area
- Improved high temperature reliability
- TO-220 package

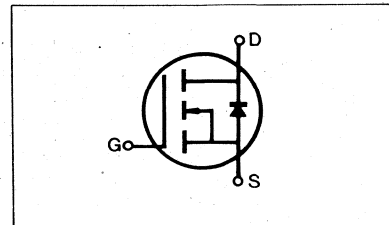
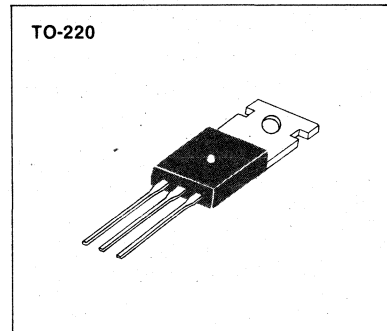

PRODUCT SUMMARY

Part Number	V_{DS}	$R_{DS(on)}$	I_D
IRF740	400V	0.55Ω	10A
IRF741	350V	0.55Ω	10A
IRF742	400V	0.80Ω	8.0A
IRF743	350V	0.80Ω	8.0A

MAXIMUM RATINGS

Characteristic	Symbol	IRF740	IRF741	IRF742	IRF743	Unit
Drain-Source Voltage (1)	V_{DSS}	400	350	400	350	Vdc
Drain-Gate Voltage ($R_{GS}=1.0M\Omega$) (1)	V_{DGR}	400	350	400	350	Vdc
Gate-Source Voltage	V_{GS}	±20				Vdc
Continuous Drain Current $T_C=25^\circ C$	I_D	10	10	8.0	8.0	Adc
Continuous Drain Current $T_C=100^\circ C$	I_D	6.0	6.0	5.0	5.0	Adc
Drain Current—Pulsed (3)	I_{DM}	40	40	32	32	Adc
Gate Current—Pulsed	I_{GM}	±1.5				Adc
Total Power Dissipation @ $T_C=25^\circ C$ Derate above $25^\circ C$	P_D	125 1.0				Watts W/°C
Operating and Storage Junction Temperature Range	T_J, T_{stg}	-55 to 150				°C
Maximum Lead Temp. for Soldering Purposes, 1/8" from case for 5 seconds	T_L	300				°C

Notes: (1) $T_J=25^\circ C$ to $150^\circ C$

(2) Pulse test: Pulse width $\leq 300\mu s$, Duty Cycle $\leq 2\%$

(3) Repetitive rating: Pulse width limited by max. junction temperature

ELECTRICAL CHARACTERISTICS (T_C=25°C unless otherwise specified)

Characteristic	Symbol	Type	Min	Typ	Max	Units	Test Conditions
Drain-Source Breakdown Voltage	BV _{DSS}	IRF740 IRF742	400	—	—	V	V _{GS} =0V
		IRF741 IRF743	350	—	—	V	I _D =250μA
Gate Threshold Voltage	V _{GS(th)}	ALL	2.0	—	4.0	V	V _{DS} =V _{GS} , I _D =250μA
Gate-Source Leakage Forward	I _{GSS}	ALL	—	—	100	nA	V _{GS} =20V
Gate-Source Leakage Reverse	I _{GSS}	ALL	—	—	-100	nA	V _{GS} =-20V
Zero Gate Voltage Drain Current	I _{DSS}	ALL	—	—	250	μA	V _{DS} =Max. Rating, V _{GS} =0V
			—	—	1000	μA	V _{DS} =Max. Rating×0.8, V _{GS} =0V, T _C =125°C
On-State Drain-Source Current (2)	I _{D(on)}	IRF740 IRF741	10	—	—	A	V _{DS} >I _{D(on)} ×R _{DS(on) max.} , V _{GS} =10V
		IRF742 IRF743	8.0	—	—	A	
Static Drain-Source On-State Resistance (2)	R _{DS(on)}	IRF740 IRF741	—	0.30	0.55	Ω	V _{GS} =10V, I _D =5.0A
		IRF742 IRF743	—	0.60	0.80	Ω	
Forward Transconductance (2)	g _{fs}	ALL	4.0	7.0	—	Ω	V _{DS} >I _{D(on)} ×R _{DS(on) max.} , I _D =5.0A
Input Capacitance	C _{iss}	ALL	—	1300	1600	pF	V _{GS} =0V, V _{DS} =25V, f=1.0MHz
Output Capacitance	C _{oss}	ALL	—	250	450	pF	
Reverse Transfer Capacitance	C _{rss}	ALL	—	50	150	pF	
Turn-On Delay Time	t _{d(on)}	ALL	—	—	35	ns	V _{DD} =0.5BV _{DSS} , I _D =5.0A, Z _O =4.7 Ω (MOSFET switching times are essentially independent of operating temperature.)
Rise Time	t _r	ALL	—	—	15	ns	
Turn-Off Delay Time	t _{d(off)}	ALL	—	—	90	ns	
Fall Time	t _f	ALL	—	—	35	ns	
Total Gate Charge (Gate-Source Plus Gate-Drain)	Q _g '	ALL	—	41	60	nC	V _{GS} =10V, I _D =12A, V _{DS} =0.8 Max. Rating (Gate charge is essentially independent of operating temperature.)
Gate-Source Charge	Q _{gs}	ALL	—	6.0	—	nC	
Gate-Drain ("Miller") Charge	Q _{gd}	ALL	—	35	—	nC	

THERMAL RESISTANCE

Junction-to-Case	R _{thJC}	ALL	—	—	1.0	K/W	
Case-to-Sink	R _{thCS}	ALL	—	1.0	—	K/W	Mounting surface flat, smooth, and greased
Junction-to-Ambient	R _{thJA}	ALL	—	—	80	K/W	Free Air Operation

- Notes:** (1) T_J=25°C to 150°C
 (2) Pulse test: Pulse width≤300μs, Duty Cycle≤2%
 (3) Repetitive rating: Pulse width limited by max. junction temperature

SOURCE-DRAIN DIODE RATINGS AND CHARACTERISTICS

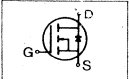
Characteristic	Symbol	Type	Min	Typ	Max	Units	Test Conditions
Continuous Source Current (Body Diode)	I_S	IRF740	—	—	10	A	Modified MOSFET symbol showing the integral reverse P-N junction rectifier 
		IRF741	—	—	10	A	
Pulse Source Current (Body Diode) (3)	I_{SM}	IRF740	—	—	40	A	
		IRF741	—	—	40	A	
Diode Forward Voltage (2)	V_{SD}	IRF740	—	—	2.0	V	$T_C=25^\circ\text{C}$, $I_S=10\text{A}$, $V_{GS}=0\text{V}$
		IRF741	—	—	2.0	V	$T_C=25^\circ\text{C}$, $I_S=10\text{A}$, $V_{GS}=0\text{V}$
Reverse Recovery Time	t_{rr}	IRF742	—	—	1.9	V	$T_C=25^\circ\text{C}$, $I_S=8.0\text{A}$, $V_{GS}=0\text{V}$
		IRF743	—	—	1.9	V	$T_C=25^\circ\text{C}$, $I_S=8.0\text{A}$, $V_{GS}=0\text{V}$
Reverse Recovery Time	t_{rr}	ALL	—	800	—	ns	$T_J=150^\circ\text{C}$, $I_F=10\text{A}$, $dI_F/dt=100\text{A}/\mu\text{s}$

Notes: (1) $T_J=25^\circ\text{C}$ to 150°C (2) Pulse test: Pulse width $\leq 300\mu\text{s}$, Duty Cycle $\leq 2\%$
 (3) Repetitive rating: Pulse width limited by max. junction temperature

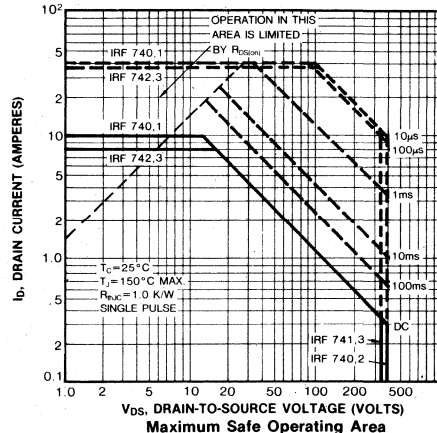
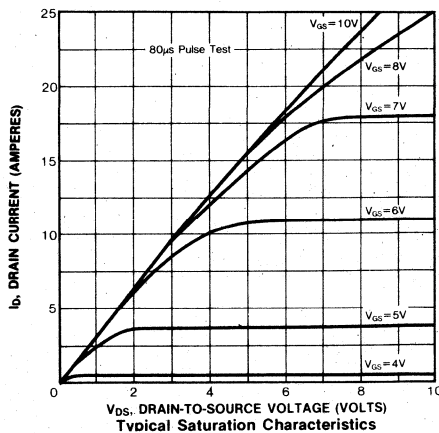
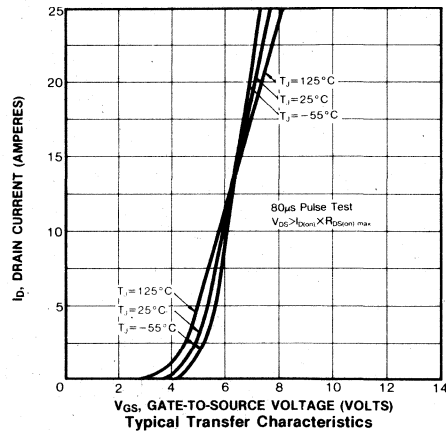
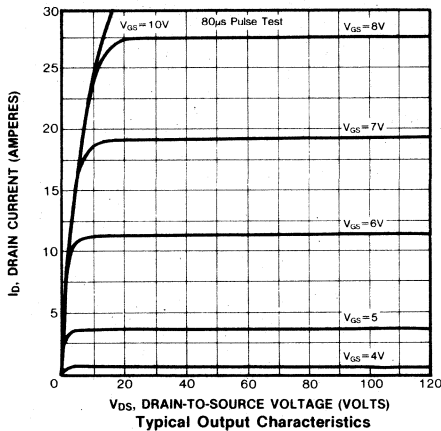

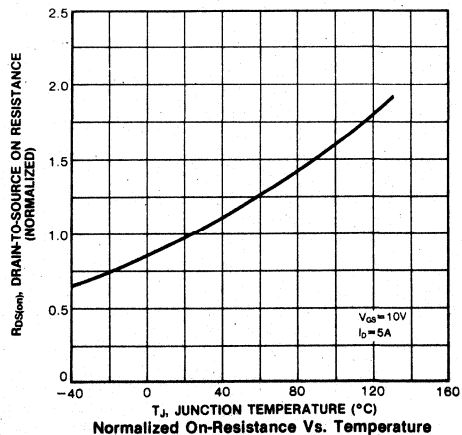
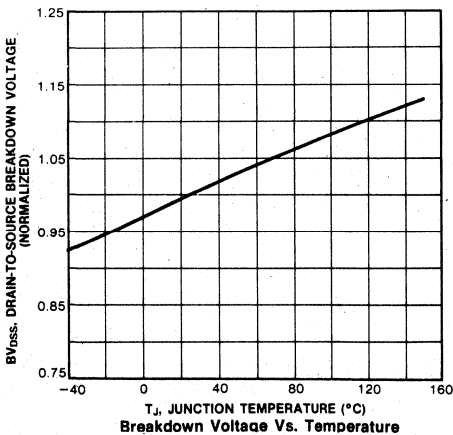
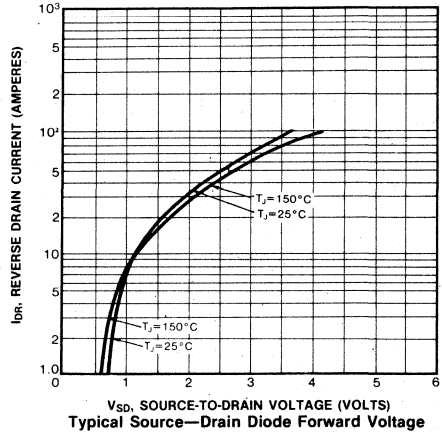
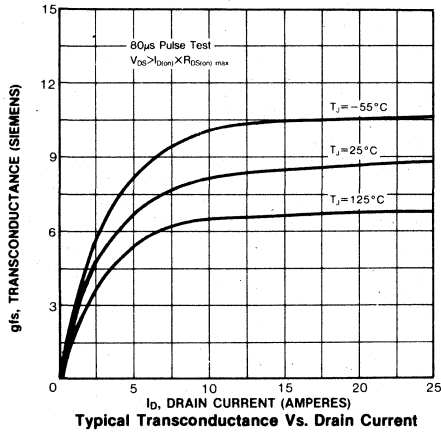
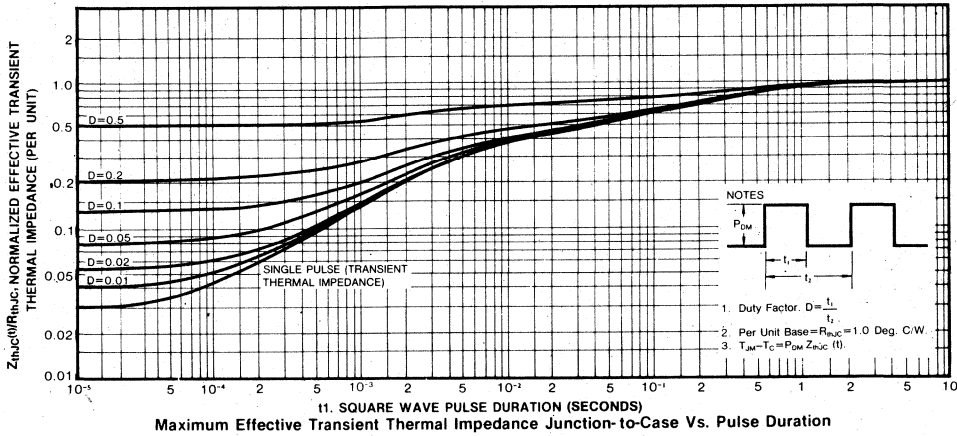

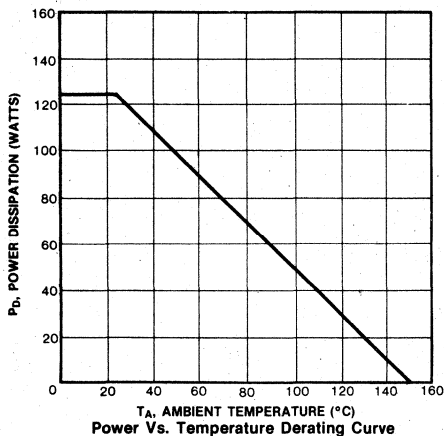
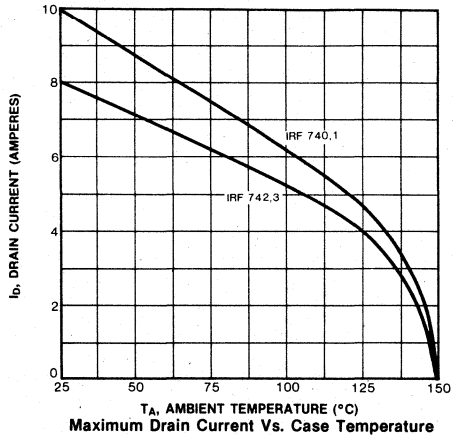
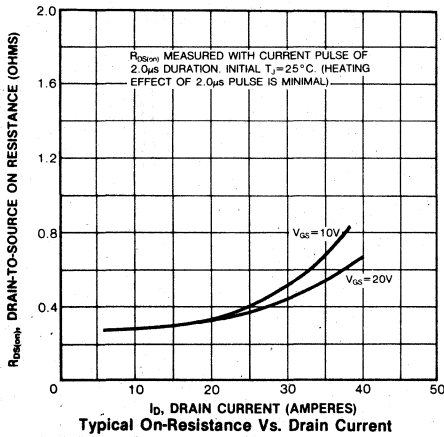
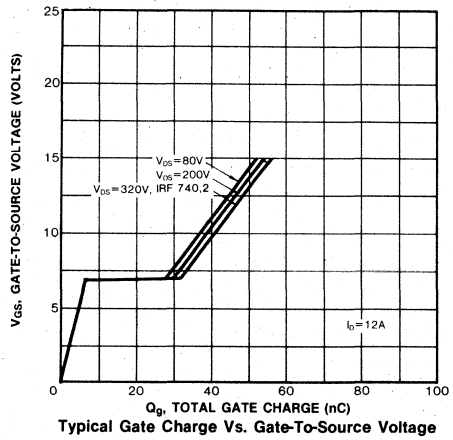
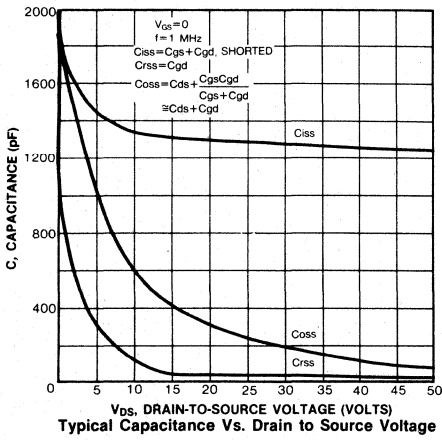

4

FEATURES

- Low $R_{DS(on)}$ at high voltage
- Improved inductive ruggedness
- Excellent high voltage stability
- Fast switching times
- Rugged polysilicon gate cell structure
- Low input capacitance
- Extended safe operating area
- Improved high temperature reliability
- TO-220 package

PRODUCT SUMMARY

Part Number	V_{DS}	$R_{DS(on)}$	I_D
IRF820	500V	3.0Ω	2.5A
IRF821	450V	3.0Ω	2.5A
IRF822	500V	4.0Ω	2.0A
IRF823	450V	4.0Ω	2.0A

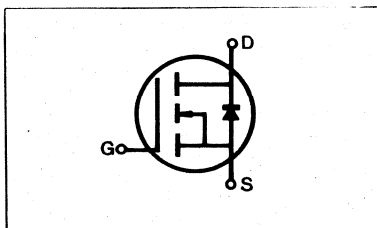
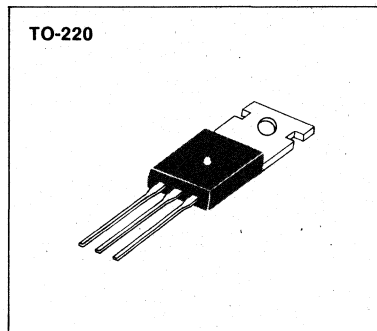

MAXIMUM RATINGS

Characteristic	Symbol	IRF820	IRF821	IRF822	IRF823	Unit
Drain-Source Voltage (1)	V_{DS}	500	450	500	450	Vdc
Drain-Gate Voltage ($R_{GS}=1.0M\Omega$) (1)	V_{DGR}	500	450	500	450	Vdc
Gate-Source Voltage	V_{GS}	±20				Vdc
Continuous Drain Current $T_C=25^\circ C$	I_D	2.5	2.5	2.0	2.0	Adc
Continuous Drain Current $T_C=100^\circ C$	I_D	1.5	1.5	1.0	1.0	Adc
Drain Current—Pulsed (3)	I_{DM}	10	10	8.0	8.0	Adc
Gate Current—Pulsed	I_{GM}	+1.5				Adc
Total Power Dissipation @ $T_C=25^\circ C$	P_D	40				Watts
Derate above $25^\circ C$		0.32				W/°C
Operating and Storage Junction Temperature Range	T_J, T_{stg}	-55 to 150				°C
Maximum Lead Temp. for Soldering Purposes, 1/8" from case for 5 seconds	T_L	300				°C

Notes: (1) $T_J=25^\circ C$ to $150^\circ C$

(2) Pulse test: Pulse width $\leq 300\mu s$, Duty Cycle $\leq 2\%$

(3) Repetitive rating: Pulse width limited by max. junction temperature

ELECTRICAL CHARACTERISTICS (T_C=25°C unless otherwise specified)

Characteristic	Symbol	Type	Min	Typ	Max	Units	Test Conditions
Drain-Source Breakdown Voltage	BV _{DSS}	IRF820 IRF822	500	—	—	V	V _{GS} =0V
		IRF821 IRF823	450	—	—	V	I _D =250μA
Gate Threshold Voltage	V _{GS(th)}	ALL	2.0	—	4.0	V	V _{DS} =V _{GS} , I _D =250μA
Gate-Source Leakage Forward	I _{GSS}	ALL	—	—	100	nA	V _{GS} =20V
Gate-Source Leakage Reverse	I _{GSS}	ALL	—	—	-100	nA	V _{GS} =-20V
Zero Gate Voltage Drain Current	I _{DSS}	ALL	—	—	250	μA	V _{DS} =Max. Rating, V _{GS} =0V
			—	—	1000	μA	V _{DS} =Max. Rating×0.8, V _{GS} =0V, T _C =125°C
On-State Drain-Source Current (2)	I _{D(on)}	IRF820 IRF821	2.5	—	—	A	V _{DS} >I _{D(on)} ×R _{Ds(on)} max., V _{GS} =10V
		IRF822 IRF823	2.0	—	—	A	
Static Drain-Source On-State Resistance (2)	R _{Ds(on)}	IRF820 IRF821	—	2.0	3.0	Ω	V _{GS} =10V, I _D =1.0A
		IRF822 IRF823	—	3.0	4.0	Ω	
Forward Transconductance (2)	g _{fs}	ALL	1.0	1.75	—	∅	V _{DS} >I _{D(on)} ×R _{Ds(on)} max., I _D =1.0A
Input Capacitance	C _{iss}	ALL	—	350	400	pF	V _{GS} =0V, V _{DS} =25V, f=1.0MHz
Output Capacitance	C _{oss}	ALL	—	90	150	pF	
Reverse Transfer Capacitance	C _{rss}	ALL	—	30	40	pF	
Turn-On Delay Time	t _{d(on)}	ALL	—	—	60	ns	V _{DD} =0.5BV _{DSS} , I _D =1.0A, Z _O =50Ω, (MOSFET switching times are essentially independent of operating temperature.)
Rise Time	t _r	ALL	—	—	50	ns	
Turn-Off Delay Time	t _{d(off)}	ALL	—	—	60	ns	
Fall Time	t _f	ALL	—	—	30	ns	
Total Gate Charge (Gate-Source Plus Gate-Drain)	Q _g	ALL	—	11.5	15	nC	V _{GS} =10V, I _D =3.0A, V _{DS} =0.8 Max. Rating (Gate charge is essentially independent of operating temperature.)
Gate-Source Charge	Q _{gs}	ALL	—	2.1	—	nC	
Gate-Drain ("Miller") Charge	Q _{gd}	ALL	—	9.4	—	nC	

THERMAL RESISTANCE

Junction-to-Case	R _{thJC}	ALL	—	—	3.12	K/W	
Case-to-Sink	R _{thCS}	ALL	—	1.0	—	K/W	Mounting surface flat, smooth, and greased
Junction-to-Ambient	R _{thJA}	ALL	—	—	80	K/W	Free Air Operation

Notes: (1) T_J=25°C to 150°C

(2) Pulse test: Pulse width≤300μs, Duty Cycle≤2%

(3) Repetitive rating: Pulse width limited by max. junction temperature

SOURCE-DRAIN DIODE RATINGS AND CHARACTERISTICS

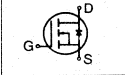
Characteristic	Symbol	Type	Min	Typ	Max	Units	Test Conditions
Continuous Source Current (Body Diode)	I_S	IRF820	—	—	2.5	A	Modified MOSFET symbol showing the integral reverse P-N junction rectifier 
		IRF821	—	—	2.0	A	
		IRF822	—	—	10	A	
		IRF823	—	—	8.0	A	
Pulse Source Current (Body Diode) (3)	I_{SM}	IRF820	—	—	1.6	V	$T_C=25^\circ\text{C}$, $I_S=2.5\text{A}$, $V_{GS}=0\text{V}$
		IRF821	—	—	1.5	V	$T_C=25^\circ\text{C}$, $I_S=2.0\text{A}$, $V_{GS}=0\text{V}$
		IRF822	—	—	—	—	—
		IRF823	—	—	—	—	—
Diode Forward Voltage (2)	V_{SD}						
Reverse Recovery Time	t_{rr}	ALL	—	600	—	ns	$T_J=150^\circ\text{C}$, $I_F=2.5\text{A}$, $dI_F/dt=100\text{A}/\mu\text{s}$

Notes: (1) $T_J=25^\circ\text{C}$ to 150°C (2) Pulse test: Pulse width $\leq 300\mu\text{s}$, Duty Cycle $\leq 2\%$
 (3) Repetitive rating: Pulse width limited by max. junction temperature

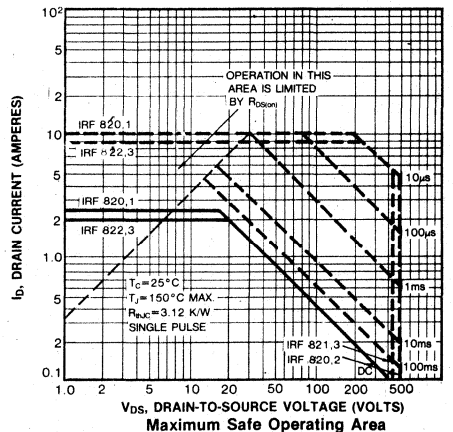
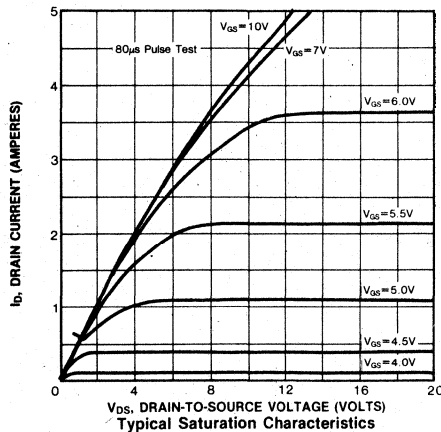
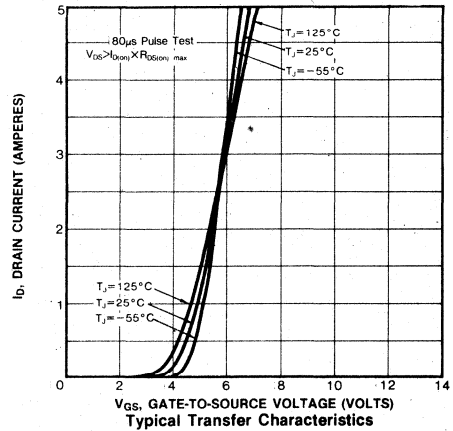
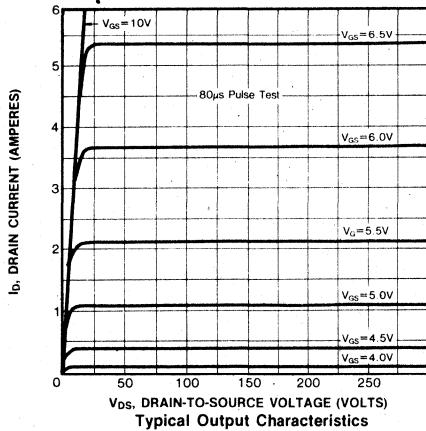

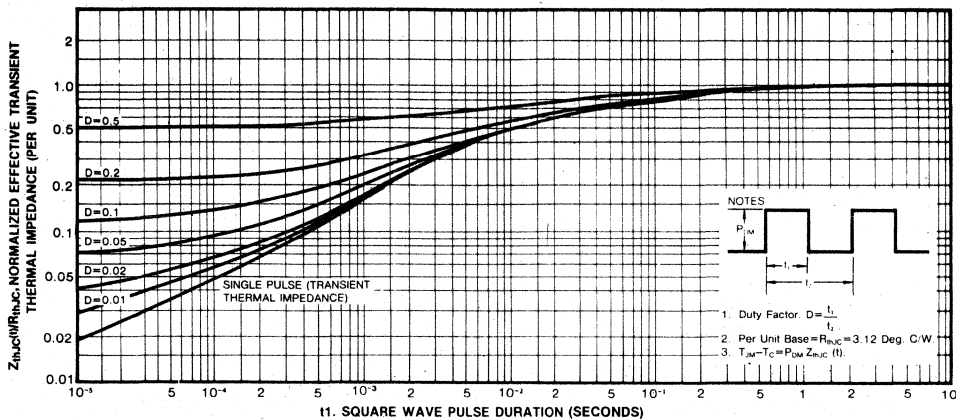

11. SQUARE WAVE PULSE DURATION (SECONDS)
Maximum Effective Transient Thermal Impedance Junction-to-Case Vs. Pulse Duration

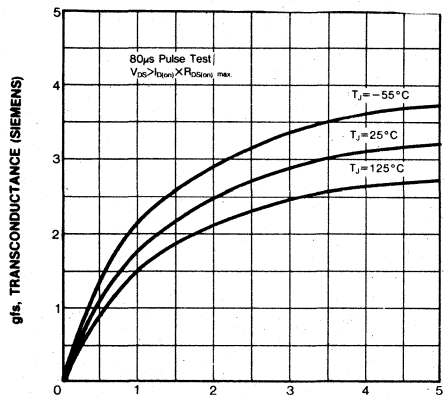

Typical Transconductance Vs. Drain Current

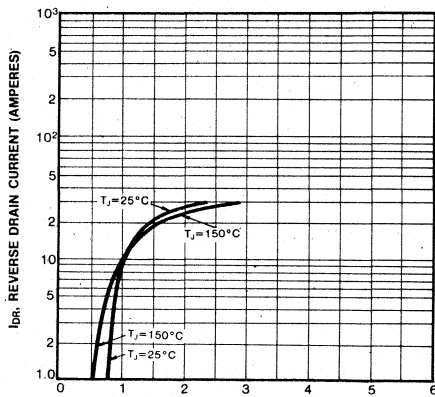

Typical Source-Drain Diode Forward Voltage

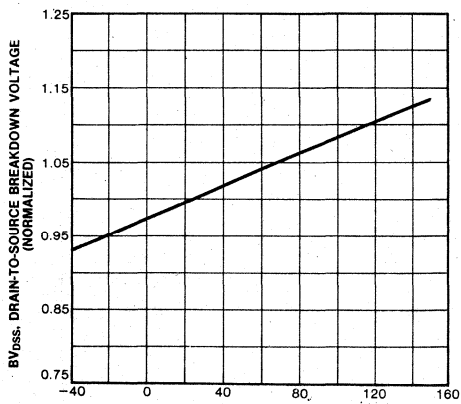

Breakdown Voltage Vs. Temperature

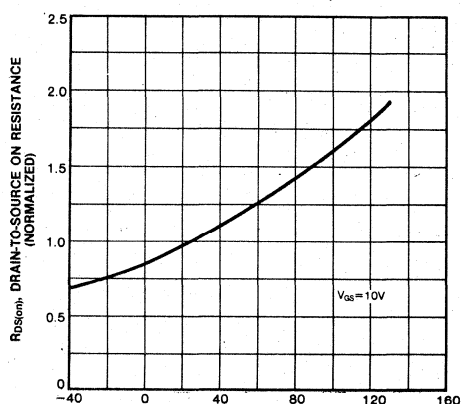

Normalized On-Resistance Vs. Temperature

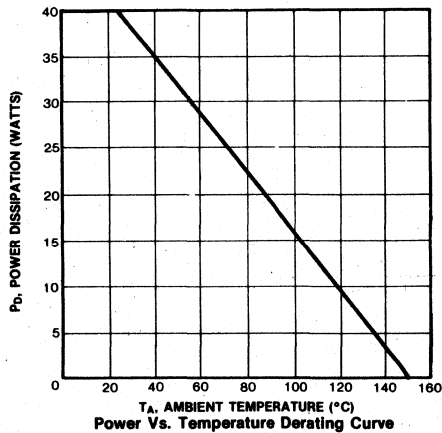
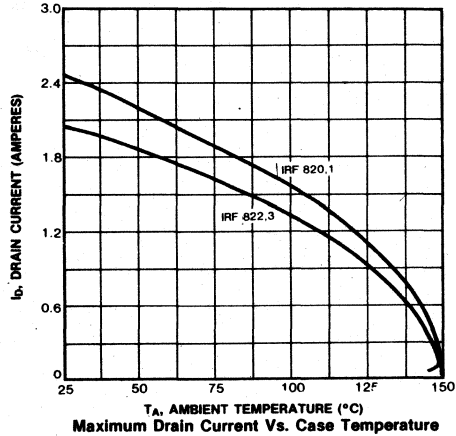
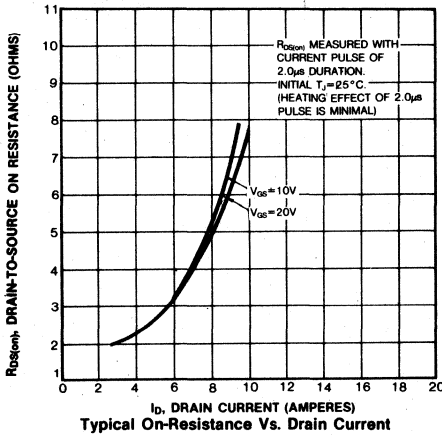
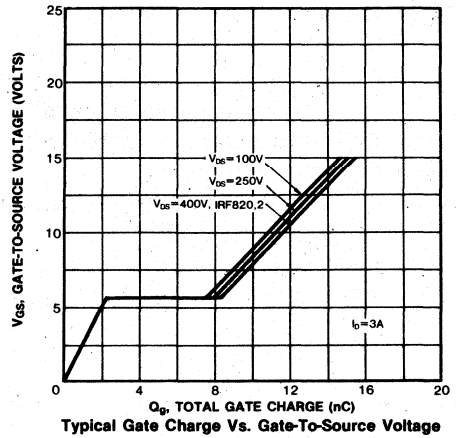
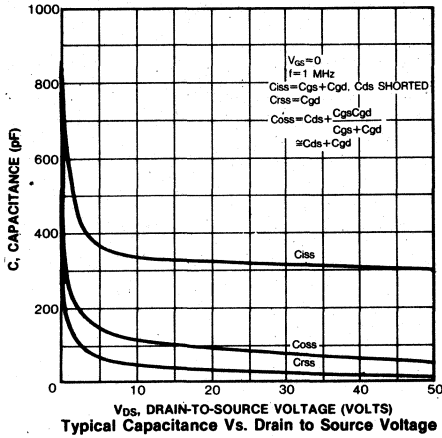

FEATURES

- Low $R_{DS(on)}$ at high voltage
- Improved inductive ruggedness
- Excellent high voltage stability
- Fast switching times
- Rugged polysilicon gate cell structure
- Lower input capacitance
- Extended safe operating area
- Improved high temperature reliability
- TO-220 package

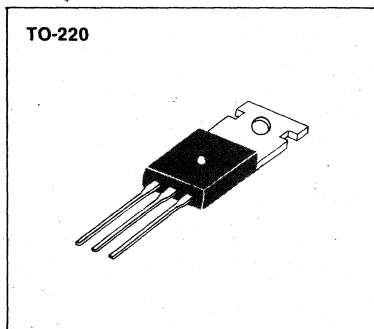

PRODUCT SUMMARY

Part Number	V_{DS}	$R_{DS(on)}$	I_D
IRF830	500V	1.5Ω	4.5A
IRF831	450V	1.5Ω	4.5A
IRF832	500V	2.0Ω	4.0A
IRF833	450V	2.0Ω	4.0A

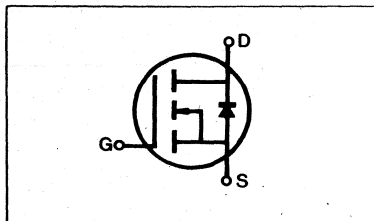

MAXIMUM RATINGS

Characteristic	Symbol	IRF830	IRF831	IRF832	IRF833	Unit
Drain-Source Voltage (1)	V_{DS}	500	450	500	450	Vdc
Drain-Gate Voltage ($R_{GS}=1.0M\Omega$) (1)	V_{DGR}	500	450	500	450	Vdc
Gate-Source Voltage	V_{GS}	±20				Vdc
Continuous Drain Current $T_C=25^\circ C$	I_D	4.5	4.5	4.0	4.0	Adc
Continuous Drain Current $T_C=100^\circ C$	I_D	3.0	3.0	2.5	2.5	Adc
Drain Current—Pulsed (3)	I_{DM}	18	18	16	16	Adc
Gate Current—Pulsed	I_{GM}	±1.5				Adc
Total Power Dissipation @ $T_C=25^\circ C$ Derate above $25^\circ C$	P_D	75 0.6				Watts W/°C
Operating and Storage Junction Temperature Range	T_J, T_{stg}	-55 to 150				°C
Maximum Lead Temp. for Soldering Purposes, 1/8" from case for 5 seconds	T_L	300				°C

- Notes: (1) $T_J=25^\circ C$ to $150^\circ C$
 (2) Pulse test: Pulse width $\leq 300\mu s$, Duty Cycle $\leq 2\%$
 (3) Repetitive rating: Pulse width limited by max. junction temperature

ELECTRICAL CHARACTERISTICS (T_C=25°C unless otherwise specified)

Characteristic	Symbol	Type	Min	Typ	Max	Units	Test Conditions
Drain-Source Breakdown Voltage	BV _{DSS}	IRF830 IRF832	500	—	—	V	V _{GS} =0V
		IRF831 IRF833	450	—	—	V	I _D =250μA
Gate Threshold Voltage	V _{GS(th)}	ALL	2.0	—	4.0	V	V _{DS} =V _{GS} , I _D =250μA
Gate-Source Leakage Forward	I _{GSS}	ALL	—	—	100	nA	V _{GS} =20V
Gate-Source Leakage Reverse	I _{GSS}	ALL	—	—	-100	nA	V _{GS} =-20V
Zero Gate Voltage Drain Current	I _{DSS}	ALL	—	—	250	μA	V _{DS} =Max. Rating, V _{GS} =0V
			—	—	1000	μA	V _{DS} =Max. Rating×0.8, V _{GS} =0V, T _C =125°C
On-State Drain-Source Current (2)	I _{D(on)}	IRF830 IRF831	4.5	—	—	A	V _{DS} >I _{D(on)} ×R _{DS(on) max.} , V _{GS} =10V
		IRF832 IRF833	4.0	—	—	A	
Static Drain-Source On-State Resistance (2)	R _{DS(on)}	IRF830 IRF831	—	0.95	1.5	Ω	V _{GS} =10V, I _D =2.5A
		IRF832 IRF833	—	1.4	2.0	Ω	
Forward Transconductance (2)	g _{fs}	ALL	2.5	3.2	—	∅	V _{DS} >I _{D(on)} ×R _{DS(on) max.} , I _D =2.5A
Input Capacitance	C _{iss}	ALL	—	720	800	pF	V _{GS} =0V, V _{DS} =25V, f=1.0MHz
Output Capacitance	C _{oss}	ALL	—	110	200	pF	
Reverse Transfer Capacitance	C _{rss}	ALL	—	50	60	pF	
Turn-On Delay Time	t _{d(on)}	ALL	—	—	30	ns	V _{DD} =0.5BV _{DSS} , I _D =2.5A, Z _O =50 Ω, (MOSFET switching times are essentially independent of operating temperature.)
Rise Time	t _r	ALL	—	—	30	ns	
Turn-Off Delay Time	t _{d(off)}	ALL	—	—	55	ns	
Fall Time	t _f	ALL	—	—	30	ns	
Total Gate Charge (Gate-Source Plus Gate-Drain)	Q _g	ALL	—	22	30	nC	V _{GS} =10V, I _D =6.0A, V _{DS} =0.8 Max. Rating (Gate charge is essentially independent of operating temperature.)
Gate-Source Charge	Q _{gs}	ALL	—	4.2	—	nC	
Gate-Drain ("Miller") Charge	Q _{gd}	ALL	—	17.8	—	nC	

THERMAL RESISTANCE

Junction-to-Case	R _{thJC}	ALL	—	—	1.67	K/W	
Case-to-Sink	R _{thCS}	ALL	—	1.0	—	K/W	Mounting surface flat, smooth, and greased
Junction-to-Ambient	R _{thJA}	ALL	—	—	80	K/W	Free Air Operation

- Notes:** (1) T_J=25°C to 150°C
 (2) Pulse test: Pulse width≤300μs, Duty Cycle≤2%
 (3) Repetitive rating: Pulse width limited by max. junction temperature

SOURCE-DRAIN DIODE RATINGS AND CHARACTERISTICS

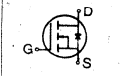
Characteristic	Symbol	Type	Min	Typ	Max	Units	Test Conditions
Continuous Source Current (Body Diode)	I_S	IRF830	—	—	4.5	A	Modified MOSFET symbol showing the integral reverse P-N junction rectifier 
		IRF831	—	—	4.5	A	
		IRF832	—	—	4.0	A	
		IRF833	—	—	4.0	A	
Pulse Source Current (Body Diode) (3)	I_{SM}	IRF830	—	—	18	A	
		IRF831	—	—	18	A	
		IRF832	—	—	16	A	
		IRF833	—	—	16	A	
Diode Forward Voltage (2)	V_{SD}	IRF830	—	—	1.6	V	$T_C=25^\circ\text{C}$, $I_S=4.5\text{A}$, $V_{GS}=0\text{V}$
		IRF831	—	—	1.6	V	$T_C=25^\circ\text{C}$, $I_S=4.0\text{A}$, $V_{GS}=0\text{V}$
		IRF832	—	—	1.5	V	$T_C=25^\circ\text{C}$, $I_S=4.0\text{A}$, $V_{GS}=0\text{V}$
Reverse Recovery Time	t_{rr}	ALL	—	800	—	ns	$T_J=150^\circ\text{C}$, $I_F=4.5\text{A}$, $di/dt=100\text{A}/\mu\text{s}$

Notes: (1) $T_J=25^\circ\text{C}$ to 150°C (2) Pulse test: Pulse width $\leq 300\mu\text{s}$, Duty Cycle $\leq 2\%$
 (3) Repetitive rating: Pulse width limited by max. junction temperature

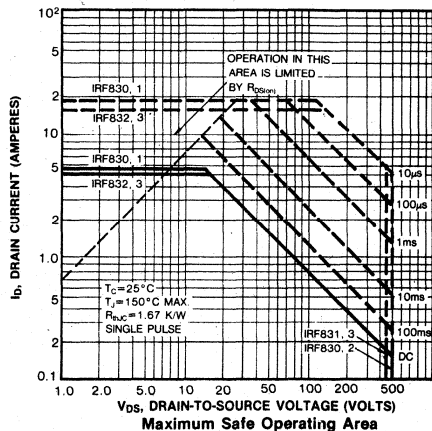
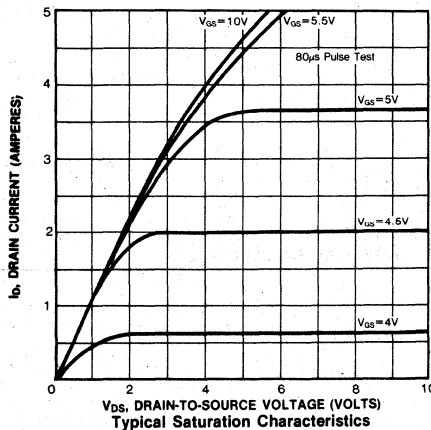
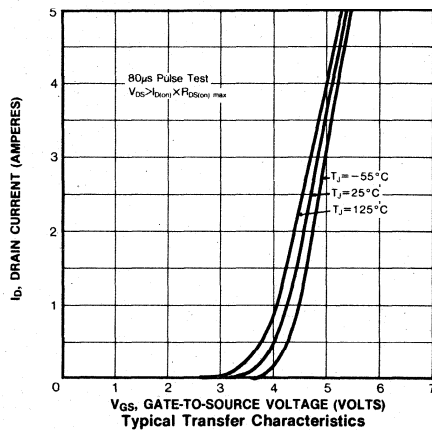
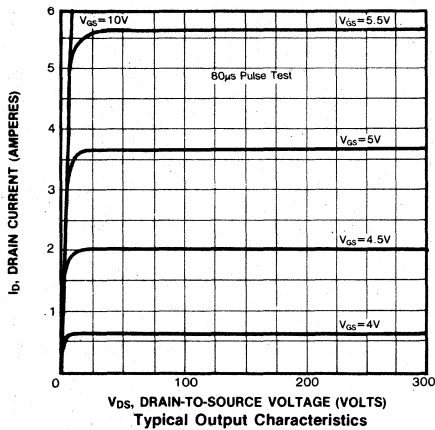

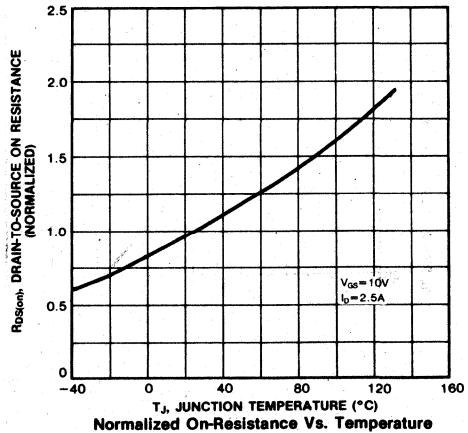
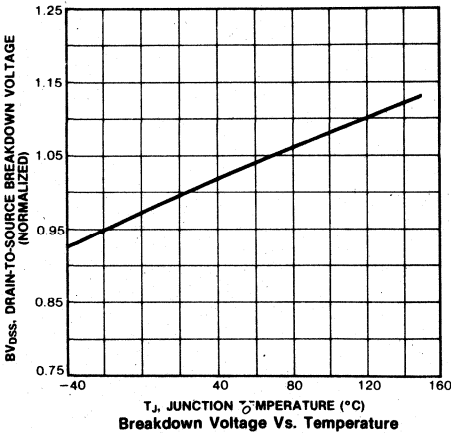
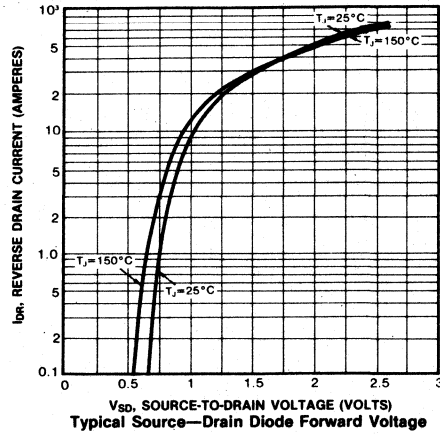
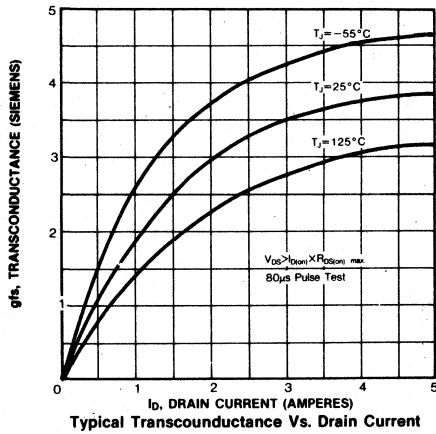
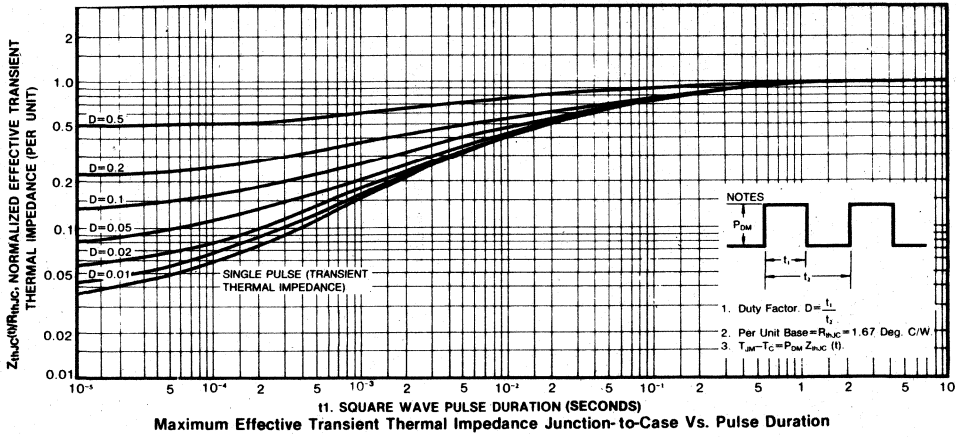

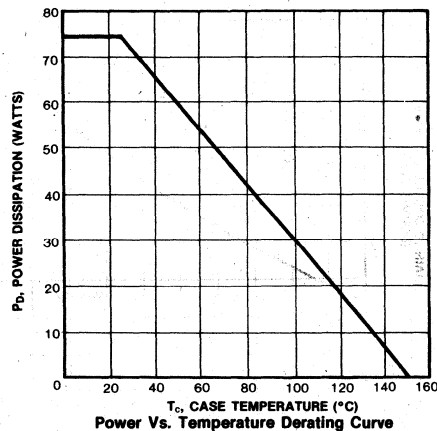
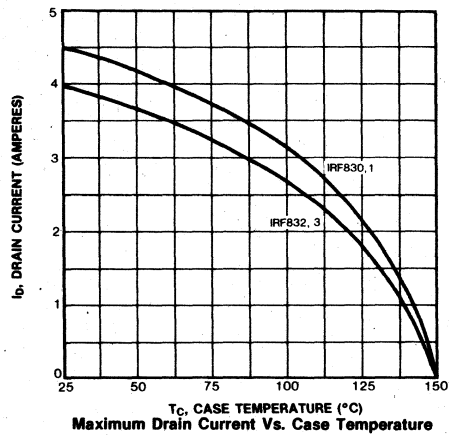
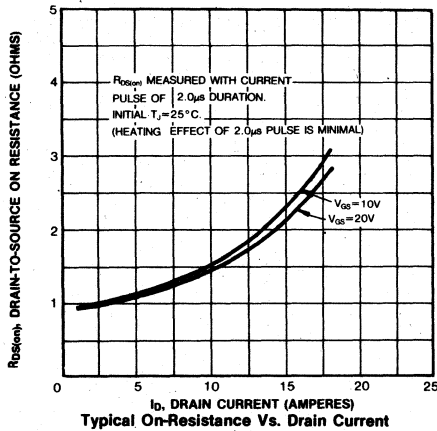
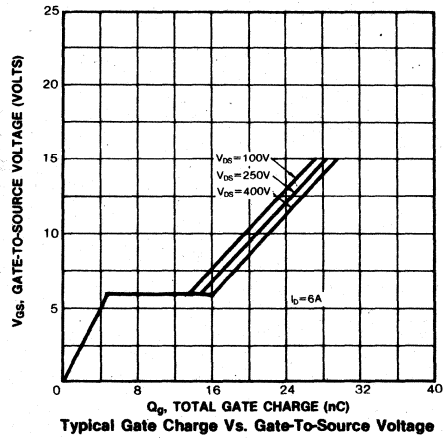
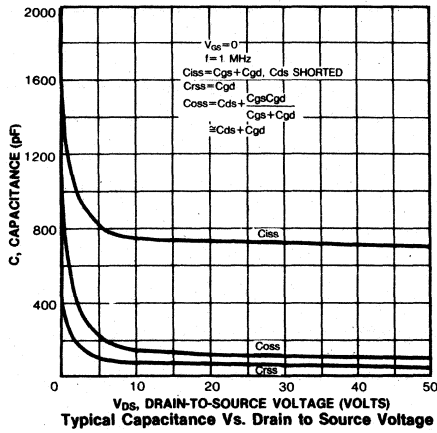

FEATURES

- Low $R_{DS(on)}$ at high voltage
- Improved inductive ruggedness
- Excellent high voltage stability
- Fast switching times
- Rugged polysilicon gate cell structure
- Low input capacitance
- Extended safe operating area
- Improved high temperature reliability
- TO-220 package

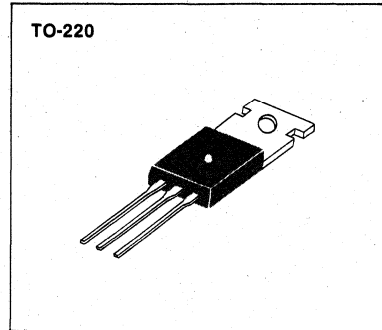

PRODUCT SUMMARY

Part Number	V_{DS}	$R_{DS(on)}$	I_D
IRF840	500V	0.85 Ω	8.0A
IRF841	450V	0.85 Ω	8.0A
IRF842	500V	1.10 Ω	7.0A
IRF843	450V	1.10 Ω	7.0A

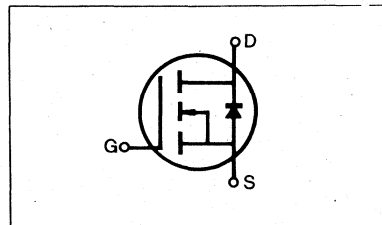

MAXIMUM RATINGS

Characteristic	Symbol	IRF840	IRF841	IRF842	IRF843	Unit
Drain-Source Voltage (1)	V_{DSS}	500	450	500	450	Vdc
Drain-Gate Voltage ($R_{GS}=1.0M\Omega$) (1)	V_{DGR}	500	450	500	450	Vdc
Gate-Source Voltage	V_{GS}	± 20				Vdc
Continuous Drain Current $T_C=25^\circ C$	I_D	8.0	8.0	7.0	7.0	Adc
Continuous Drain Current $T_C=100^\circ C$	I_D	5.0	5.0	4.0	4.0	Adc
Drain Current—Pulsed (3)	I_{DM}	32	32	28	28	Adc
Gate Current—Pulsed	I_{GM}	± 1.5				Adc
Total Power Dissipation @ $T_C=25^\circ C$ Derate above $25^\circ C$	P_D	125 1.0				Watts W/ $^\circ C$
Operating and Storage Junction Temperature Range	T_J, T_{stg}	-55 to 150				$^\circ C$
Maximum Lead Temp. for Soldering Purposes, 1/8" from case for 5 seconds	T_L	300				$^\circ C$

- Notes: (1) $T_J=25^\circ C$ to $150^\circ C$
 (2) Pulse test: Pulse width $\leq 300\mu s$, Duty Cycle $\leq 2\%$
 (3) Repetitive rating: Pulse width limited by max. junction temperature

ELECTRICAL CHARACTERISTICS (T_C=25°C unless otherwise specified)

Characteristic	Symbol	Type	Min	Typ	Max	Units	Test Conditions
Drain-Source Breakdown Voltage	BV _{DSS}	IRF840 IRF842	500	—	—	V	V _{GS} =0V
		IRF841 IRF843	450	—	—	V	I _D =250μA
Gate Threshold Voltage	V _{GS(th)}	ALL	2.0	—	4.0	V	V _{DS} =V _{GS} , I _D =250μA
Gate-Source Leakage Forward	I _{GSS}	ALL	—	—	100	nA	V _{GS} =20V
Gate-Source Leakage Reverse	I _{GSS}	ALL	—	—	-100	nA	V _{GS} =-20V
Zero Gate Voltage Drain Current	I _{DSS}	ALL	—	—	250	μA	V _{DS} =Max. Rating, V _{GS} =0V
			—	—	1000	μA	V _{DS} =Max. Rating×0.8, V _{GS} =0V, T _C =125°C
On-State Drain-Source Current (2)	I _{D(on)}	IRF840 IRF841	8.0	—	—	A	V _{DS} >I _{D(on)} ×R _{DS(on)} max., V _{GS} =10V
		IRF842 IRF843	7.0	—	—	A	
Static Drain-Source On-State Resistance (2)	R _{DS(on)}	IRF840 IRF841	—	0.6	0.85	Ω	V _{GS} =10V, I _D =4.0A
		IRF842 IRF843	—	1.0	1.1	Ω	
Forward Transconductance (2)	g _{fs}	ALL	4.0	6.5	—	Ω	V _{DS} >I _{D(on)} ×R _{DS(on)} max., I _D =4.0A
Input Capacitance	C _{iss}	ALL	—	1200	1600	pF	V _{GS} =0V, V _{DS} =25V, f=1.0MHz
Output Capacitance	C _{oss}	ALL	—	230	350	pF	
Reverse Transfer Capacitance	C _{rss}	ALL	—	65	150	pF	
Turn-On Delay Time	t _{d(on)}	ALL	—	—	35	ns	V _{DD} =0.5BV _{DSS} , I _D =4.0A, Z _O =4.7 Ω (MOSFET switching times are essentially independent of operating temperature.)
Rise Time	t _r	ALL	—	—	15	ns	
Turn-Off Delay Time	t _{d(off)}	ALL	—	—	90	ns	
Fall Time	t _f	ALL	—	—	30	ns	
Total Gate Charge (Gate-Source Plus Gate-Drain)	Q _g	ALL	—	34	60	nC	V _{GS} =10V, I _D =10A, V _{DS} =0.8 Max. Rating (Gate charge is essentially independent of operating temperature. See
Gate-Source Charge	Q _{gs}	ALL	—	6.0	—	nC	
Gate-Drain ("Miller") Charge	Q _{gd}	ALL	—	28	—	nC	

THERMAL RESISTANCE

Junction-to-Case	R _{thJC}	ALL	—	—	1.0	K/W	
Case-to-Sink	R _{thCS}	ALL	—	1.0	—	K/W	Mounting surface flat, smooth, and greased
Junction-to-Ambient	R _{thJA}	ALL	—	—	80	K/W	Free Air Operation

- Notes:** (1) T_J=25°C to 150°C
 (2) Pulse test: Pulse width≤300μs, Duty Cycle≤2%
 (3) Repetitive rating: Pulse width limited by max. junction temperature

SOURCE-DRAIN DIODE RATINGS AND CHARACTERISTICS

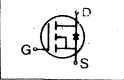
Characteristic	Symbol	Type	Min	Typ	Max	Units	Test Conditions
Continuous Source Current (Body Diode)	I _S	IRF840	—	—	8.0	A	Modified MOSFET symbol showing the integral reverse P-N junction rectifier 
		IRF841	—	—	8.0	A	
Pulse Source Current (Body Diode) (3)	I _{SM}	IRF840	—	—	32	A	
		IRF841	—	—	32	A	
Diode Forward Voltage (2)	V _{SD}	IRF840	—	—	2.0	V	T _C =25°C, I _S =8.0A, V _{GS} =0V
		IRF841	—	—	2.0	V	T _C =25°C, I _S =8.0A, V _{GS} =0V
Reverse Recovery Time	t _{rr}	IRF842	—	—	1.9	V	T _C =25°C, I _S =7.0A, V _{GS} =0V
		IRF843	—	—	1.9	V	T _C =25°C, I _S =7.0A, V _{GS} =0V
Reverse Recovery Time	t _{rr}	ALL	—	1100	—	ns	T _J =150°C, I _F =8.0A, dI _F /dt=100A/μs

Notes: (1) T_J=25°C to 150°C (2) Pulse test: Pulse width ≤ 300μs, Duty Cycle ≤ 2%
 (3) Repetitive rating: Pulse width limited by max. junction temperature

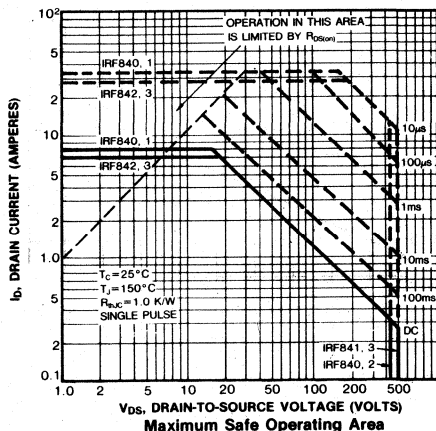
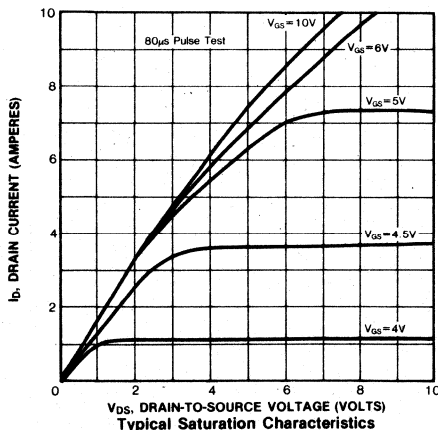
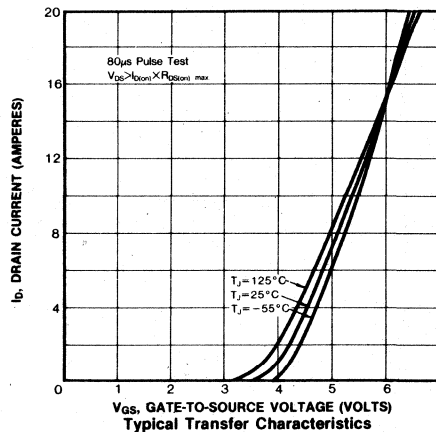
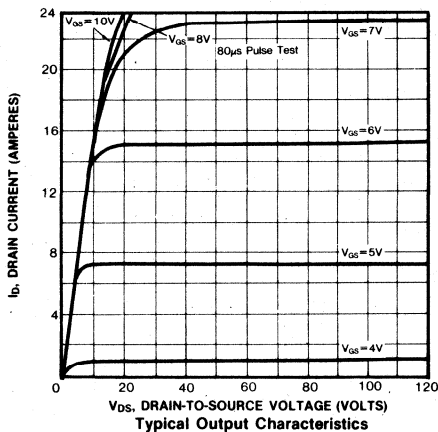

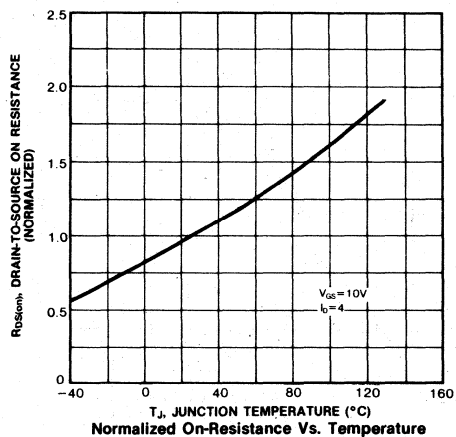
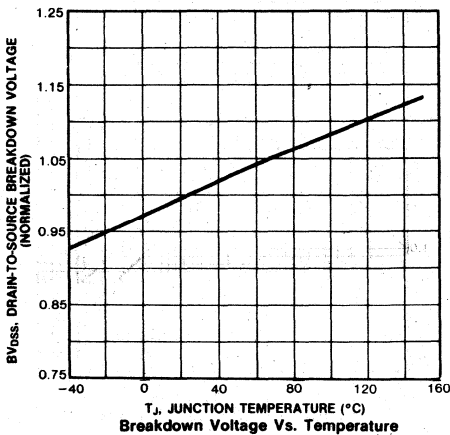
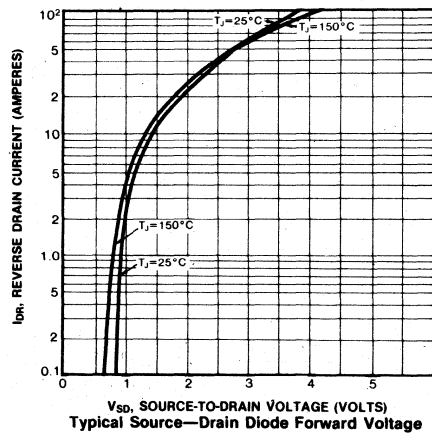
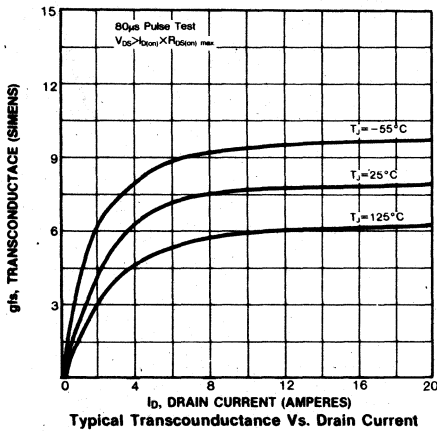
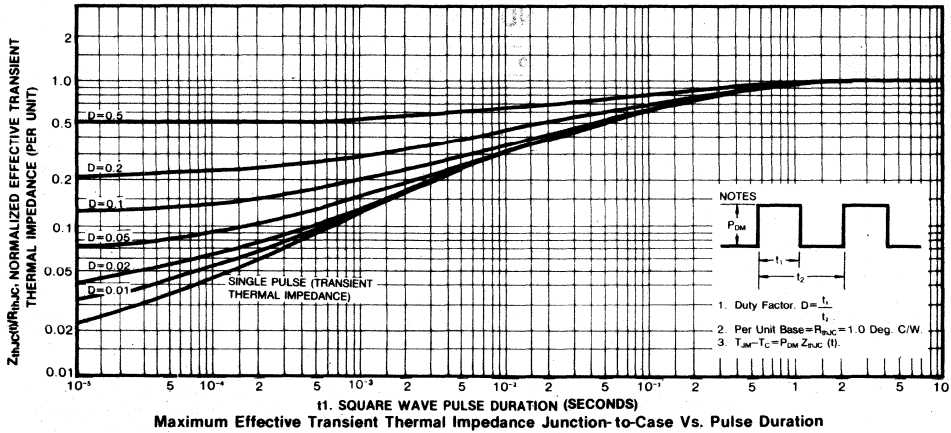

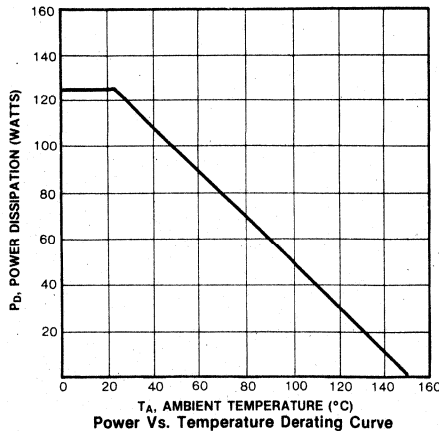
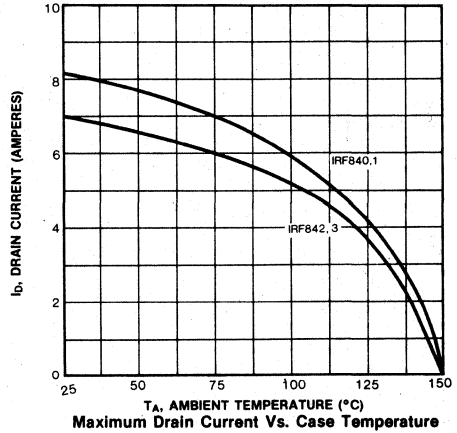
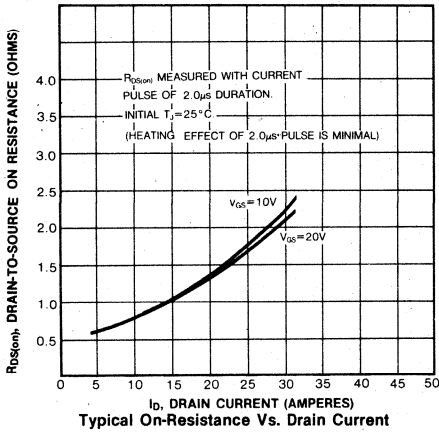
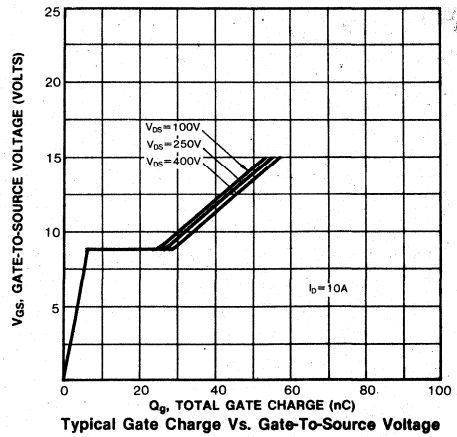
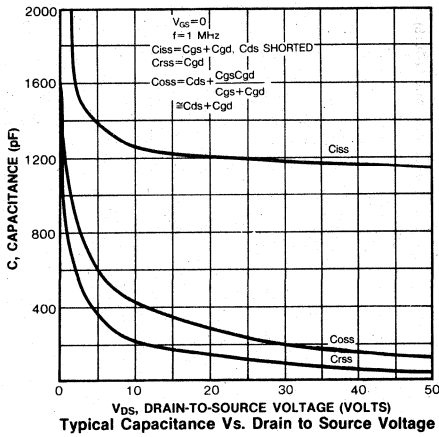

FEATURES

- Low $R_{DS(on)}$ at high voltage
- Improved inductive ruggedness
- Excellent high voltage stability
- Fast switching times
- Rugged polysilicon gate cell structure
- Low input capacitance
- Extended safe operating area
- Improved high temperature reliability
- TO-3 package (High voltage)

PRODUCT SUMMARY

Part Number	V_{DS}	$R_{DS(on)}$	I_D
SSM3N70	700V	5.0 Ω	3A

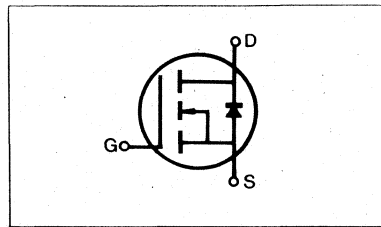
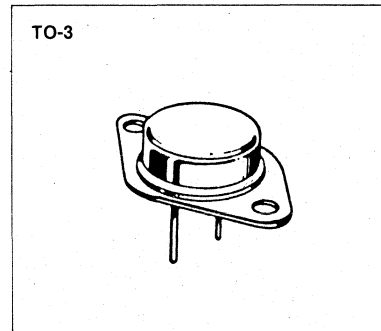

MAXIMUM RATINGS

Characteristic	Symbol	SSM3N70	Unit
Drain-Source Voltage (1)	V_{DSS}	700	Vdc
Drain-Gate Voltage ($R_{GS}=1.0M\Omega$) (1)	V_{DGR}	700	Vdc
Gate-Source Voltage	V_{GS}	± 20	Vdc
Continuous Drain Current $T_C=25^\circ C$	I_D	3	Adc
Continuous Drain Current $T_C=100^\circ C$	I_D	2	Adc
Drain Current—Pulsed (3)	I_{DM}	12	Adc
Gate Current—Pulsed	I_{GM}	± 1.5	Adc
Total Power Dissipation @ $T_C=25^\circ C$	P_D	75	Watts
Derate above $25^\circ C$		0.6	W/ $^\circ C$
Operating and Storage Junction Temperature Range	T_J, T_{stg}	-55 to 150	$^\circ C$
Maximum Lead Temp. for Soldering Purposes, 1/8" from case for 5 seconds	T_L	300	$^\circ C$

- Notes:** (1) $T_J=25^\circ C$ to $150^\circ C$
 (2) Pulse test: Pulse width $\leq 300\mu s$, Duty Cycle $\leq 2\%$
 (3) Repetitive rating: Pulse width limited by max. junction temperature

ELECTRICAL CHARACTERISTICS (T_C=25°C unless otherwise specified)

Characteristic	Symbol	Type	Min	Typ	Max	Units	Test Conditions
Drain-Source Breakdown Voltage	BV _{DSS}	ALL	700	—	—	V	V _{GS} =0V I _D =250μA
Gate Threshold Voltage	V _{GS(th)}	ALL	2.0	—	4.5	V	V _{DS} =V _{GS} , I _D =250μA
Gate-Source Leakage Forward	I _{GSS}	ALL	—	—	100	nA	V _{GS} =20V
Gate-Source Leakage Reverse	I _{GSS}	ALL	—	—	-100	nA	V _{GS} =-20V
Zero Gate Voltage Drain Current	I _{DSS}	ALL	—	—	250	μA	V _{DS} =Max. Rating, V _{GS} =0V
			—	—	1000	μA	V _{DS} =Max. Rating×0.8, V _{GS} =0V, T _C =125°C
On-State Drain-Source Current(2)	I _{D(on)}	ALL	3.0	—	—	A	V _{DS} >I _{D(on)} ×R _{Ds(on)} max., V _{GS} =10V
Static Drain-Source On-State Resistance (2)	R _{Ds(on)}	ALL	—	4.8	5.0	Ω	V _{GS} =10V, I _D =1.5A
Forward Transconductance (2)	g _{fs}	ALL	1.5	2.5	—	Ω	V _{DS} >I _{D(on)} ×R _{Ds(on)} max., I _D =1.5A
Input Capacitance	C _{iss}	ALL	—	730	900	pF	V _{GS} =0V, V _{DS} =25V, f=1.0MHz
Output Capacitance	C _{oss}	ALL	—	70	75	pF	
Reverse Transfer Capacitance	C _{rss}	ALL	—	20	25	pF	
Turn-On Delay Time	t _{d(on)}	ALL	—	—	40	ns	V _{DD} =0.5BV _{DSS} , I _D =1.5A, Z _O =15Ω (MOSFET switching times are essentially independent of operating temperature.)
Rise Time	t _r	ALL	—	—	95	ns	
Turn-Off Delay Time	t _{d(off)}	ALL	—	—	150	ns	
Fall Time	t _f	ALL	—	—	60	ns	
Total Gate Charge (Gate-Source Plus Gate-Drain)	Q _g	ALL	—	—	25	nC	V _{GS} =10V, I _D =4.0A, V _{DS} =0.8 Max. Rating (Gate charge is essentially independent of operating temperature.)
Gate-Source Charge	Q _{gs}	ALL	—	—	10	nC	
Gate-Drain ("Miller") Charge	Q _{gd}	ALL	—	—	15	nC	

THERMAL RESISTANCE

Junction-to-Case	R _{thJC}	ALL	—	—	1.67	K/W	
Case-to-Sink	R _{thCS}	ALL	—	0.1	—	K/W	Mounting surface flat, smooth, and greased
Junction-to-Ambient	R _{thJA}	ALL	—	—	30.0	K/W	Free Air Operation

SOURCE-DRAIN DIODE RATINGS AND CHARACTERISTICS

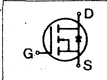
Continuous Source Current (Body Diode)	I _S	ALL	—	—	3.0	A	Modified MOSFET symbol showing the integral reverse P-N junction rectifier	
Pulse Source Current (Body Diode) (3)	I _{SM}	ALL	—	—	12.0	A		
Diode Forward Voltage (2)	V _{SD}	ALL	—	—	1.5	V	T _C =25°C, I _S =3.0A, V _{GS} =0V	
Reverse Recovery Time	t _{rr}	ALL	—	500	—	ns	T _J =150°C, I _F =3.0A, di/dt=100A/μs	

Notes: (1) T_J=25°C to 150°C

(2) Pulse test: Pulse width≤300μs, Duty Cycle≤2%

(3) Repetitive rating: Pulse width limited by max. junction temperature

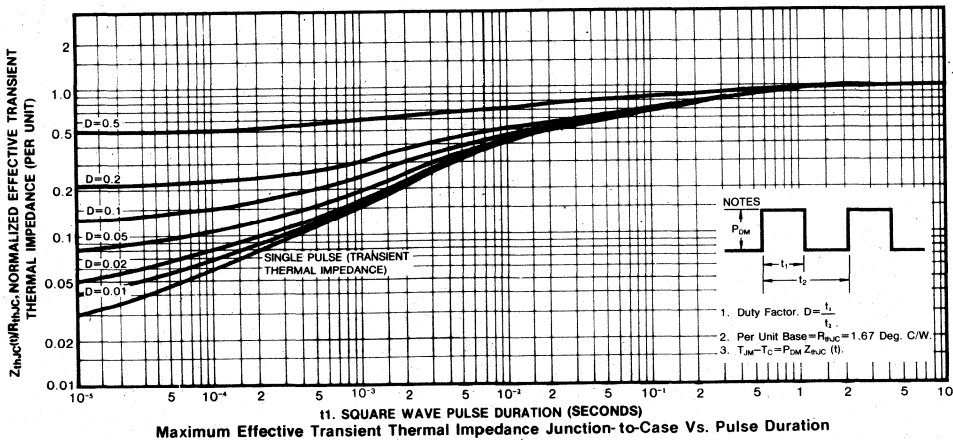
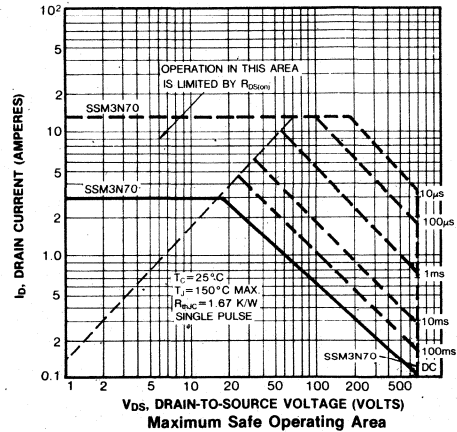
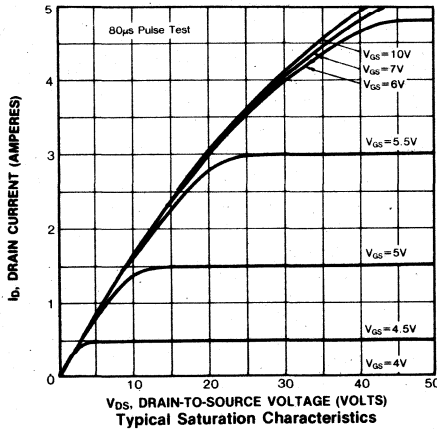
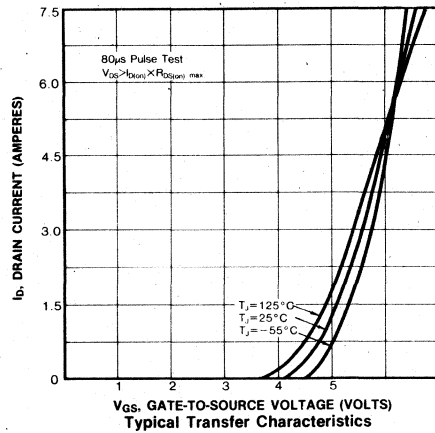
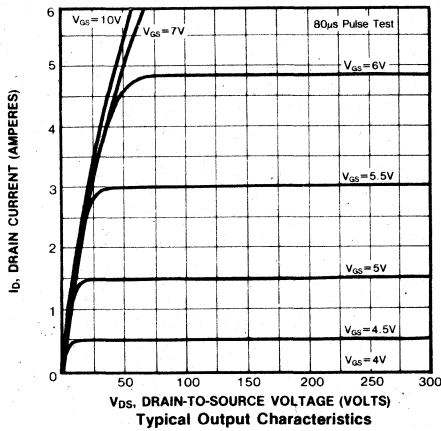

4

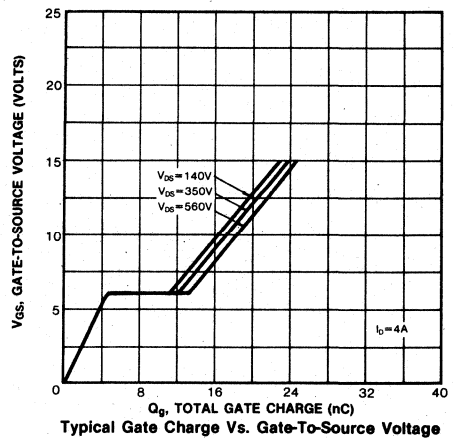
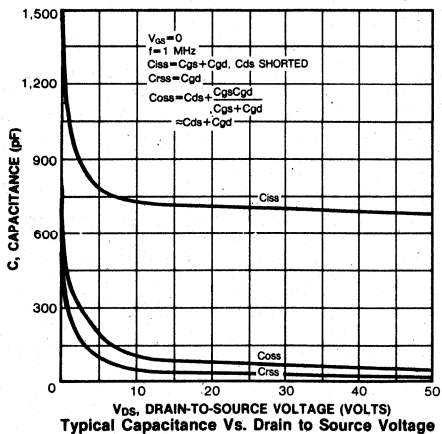
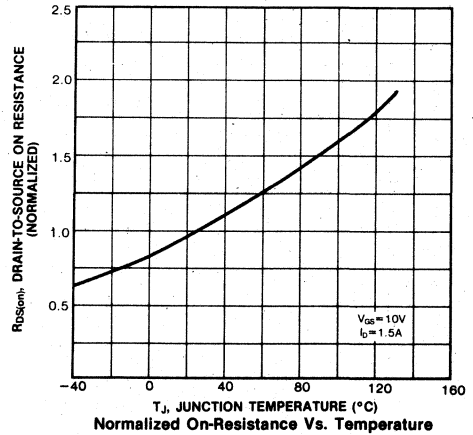
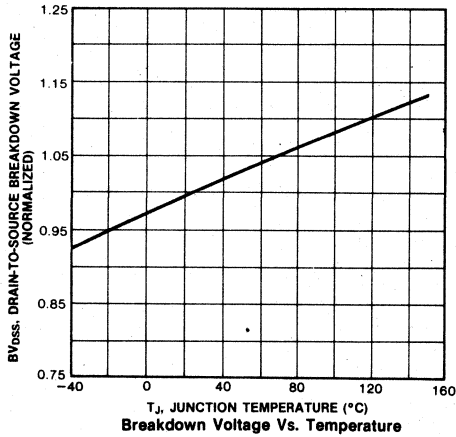
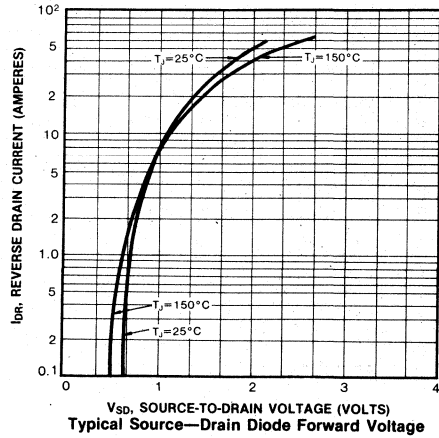
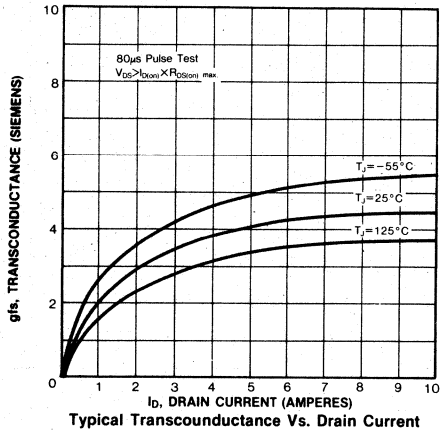

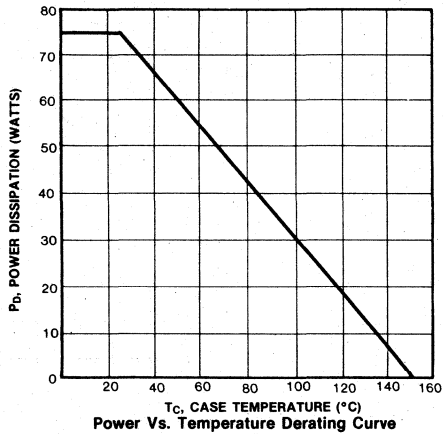
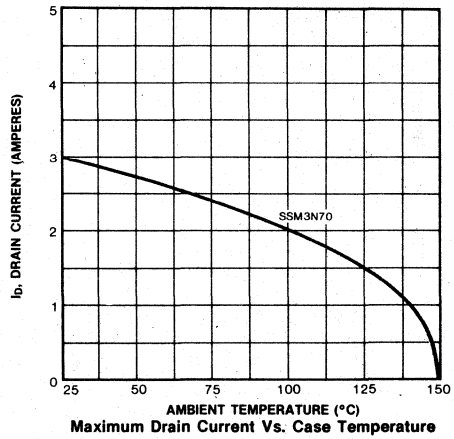
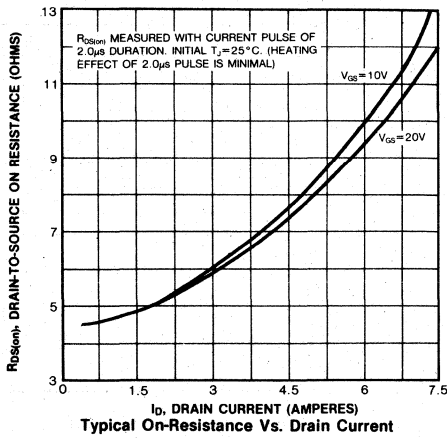

4

FEATURES

- Low $R_{DS(on)}$ at high voltage
- Improved inductive ruggedness
- Excellent high voltage stability
- Fast switching times
- Rugged polysilicon gate cell structure
- Low input capacitance
- Extended safe operating area
- Improved high temperature reliability
- TO-3 package (High voltage)

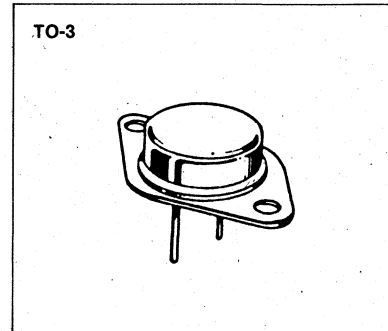

PRODUCT SUMMARY

Part Number	V_{DS}	$R_{DS(on)}$	I_D
SSM4N55	550V	3.0Ω	4A
SSM4N60	600V	3.0Ω	4A

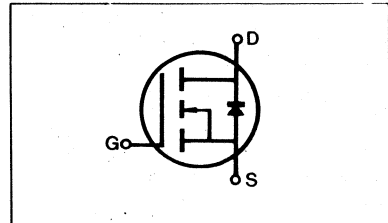

MAXIMUM RATINGS

Characteristic	Symbol	SSM4N55	SSM4N60	Unit
Drain-Source Voltage (1)	V_{DSS}	550	600	Vdc
Drain-Gate Voltage ($R_{GS}=1.0M\Omega$) (1)	V_{DGR}	550	600	Vdc
Gate-Source Voltage	V_{GS}	±20		Vdc
Continuous Drain Current $T_C=25^\circ C$	I_D	4	4	Adc
Continuous Drain Current $T_C=100^\circ C$	I_D	2.5	2.5	Adc
Drain Current—Pulsed (3)	I_{DM}	16	16	Adc
Gate Current—Pulsed	I_{GM}	±1.5		Adc
Total Power Dissipation @ $T_C=25^\circ C$ Derate above $25^\circ C$	P_D	75 0.6		Watts W/ $^\circ C$
Operating and Storage Junction Temperature Range	T_J, T_{stg}	-55 to 150		$^\circ C$
Maximum Lead Temp. for Soldering Purposes, 1/8" from case for 5 seconds	T_L	300		$^\circ C$

Notes: (1) $T_J=25^\circ C$ to $150^\circ C$

(2) Pulse test: Pulse width $\leq 300\mu s$, Duty Cycle $\leq 2\%$

(3) Repetitive rating: Pulse width limited by max. junction temperature

ELECTRICAL CHARACTERISTICS (T_C=25°C unless otherwise specified)

Characteristic	Symbol	Type	Min	Typ	Max	Units	Test Conditions
Drain-Source Breakdown Voltage	BV _{DSS}	SSM4N55	550	—	—	V	V _{GS} =0V
		SSM4N60	600	—	—	V	I _D =250μA
Gate Threshold Voltage	V _{GS(th)}	ALL	2.0	—	4.5	V	V _{DS} =V _{GS} , I _D =250μA
Gate-Source Leakage Forward	I _{GSS}	ALL	—	—	100	nA	V _{GS} =20V
Gate-Source Leakage Reverse	I _{GSS}	ALL	—	—	-100	nA	V _{GS} =-20V
Zero Gate Voltage Drain Current	I _{DSS}	ALL	—	—	250	μA	V _{DS} =Max. Rating, V _{GS} =0V
			—	—	1000	μA	V _{DS} =Max. Rating×0.8, V _{GS} =0V, T _C =125°C
On-State Drain-Source Current (2)	I _{D(on)}	ALL	4.0	—	—	A	V _{DS} >I _{D(on)} ×R _{DS(on)} max., V _{GS} =10V
Static Drain-Source On-State Resistance (2)	R _{DS(on)}	ALL	—	2.0	3.0	Ω	V _{GS} =10V, I _D =2.0A
Forward Transconductance (2)	g _{fs}	ALL	2.0	3.1	—	S	V _{DS} >I _{D(on)} ×R _{DS(on)} max., I _D =2.0A
Input Capacitance	C _{iss}	ALL	—	720	900	pF	V _{GS} =0V, V _{DS} =25V, f=1.0MHz
Output Capacitance	C _{oss}	ALL	—	110	200	pF	
Reverse Transfer Capacitance	C _{rss}	ALL	—	40	60	pF	
Turn-On Delay Time	t _{d(on)}	ALL	—	—	40	ns	V _{DD} =0.5BV _{DSS} , I _D =2.0A, Z _O =15Ω (MOSFET switching times are essentially independent of operating temperature.)
Rise Time	t _r	ALL	—	—	95	ns	
Turn-Off Delay Time	t _{d(off)}	ALL	—	—	150	ns	
Fall Time	t _f	ALL	—	—	60	ns	
Total Gate Charge (Gate-Source Plus Gate-Drain)	Q _g	ALL	—	—	25	nC	V _{GS} =10V, I _D =5.0A, V _{DS} =0.8 Max. Rating (Gate charge is essentially independent of operating temperature.)
Gate-Source Charge	Q _{gs}	ALL	—	—	10	nC	
Gate-Drain ("Miller") Charge	Q _{gd}	ALL	—	—	15	nC	

THERMAL RESISTANCE

Junction-to-Case	R _{thJC}	ALL	—	—	1.67	K/W	
Case-to-Sink	R _{thCS}	ALL	—	0.1	—	K/W	Mounting surface flat, smooth, and greased
Junction-to-Ambient	R _{thJA}	ALL	—	—	—	K/W	Free Air Operation

SOURCE-DRAIN DIODE RATINGS AND CHARACTERISTICS

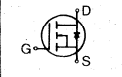
Characteristic	Symbol	Type	Min	Typ	Max	Units	Test Conditions
Continuous Source Current (Body Diode)	I _S	ALL	—	30	4.0	A	Modified MOSFET symbol showing the integral reverse P-N junction rectifier 
Pulse Source Current (Body Diode) (3)	I _{SM}	ALL	—	—	16.0	A	
Diode Forward Voltage (2)	V _{SD}	ALL	—	—	1.5	V	T _C =25°C, I _S =4.0A, V _{GS} =0V
Reverse Recovery Time	t _{rr}	ALL	—	600	—	ns	T _J =150°C, I _F =4.0A, dI _F /dt=100A/μs

Notes: (1) T_J=25°C to 150°C

(2) Pulse test: Pulse width≤300μs, Duty Cycle≤2%

(3) Repetitive rating: Pulse width limited by max. junction temperature

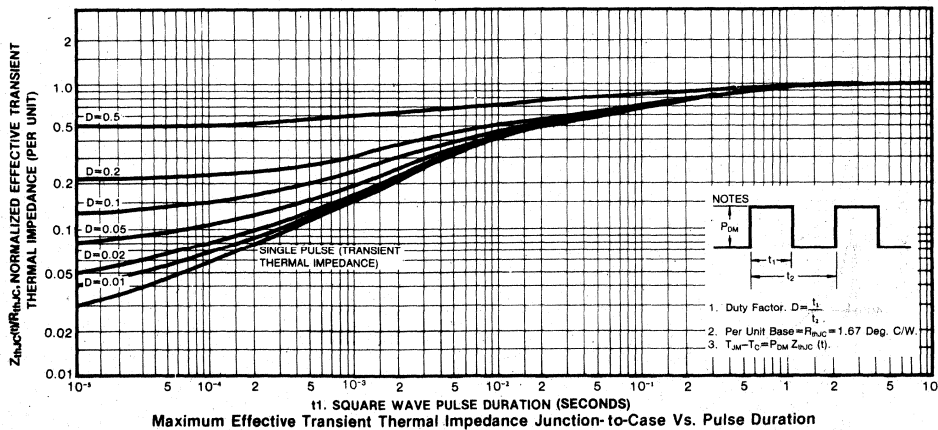
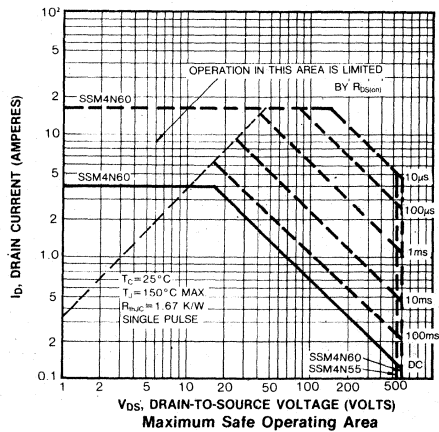
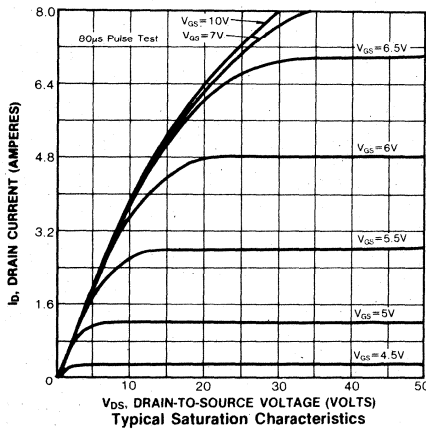
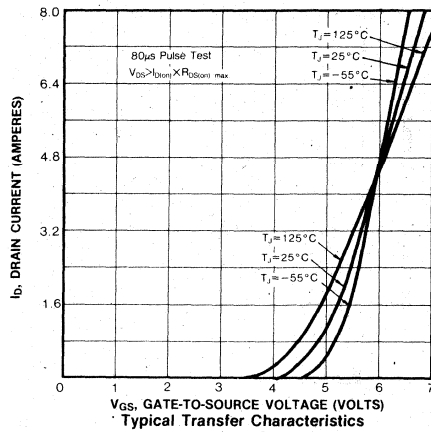
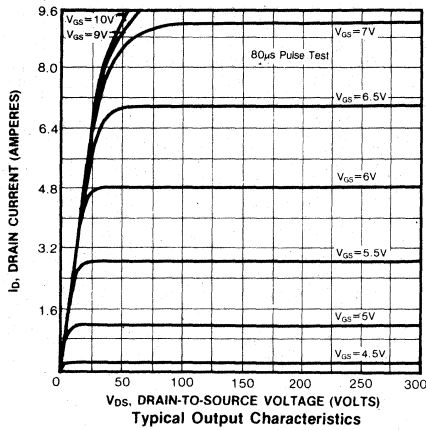

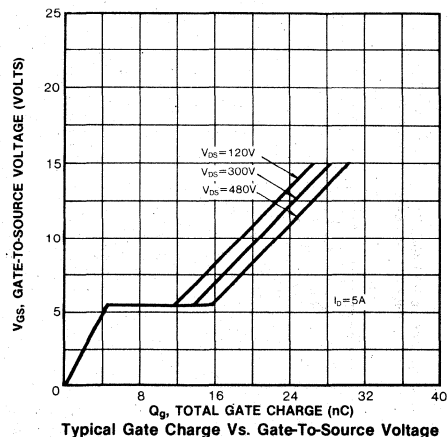
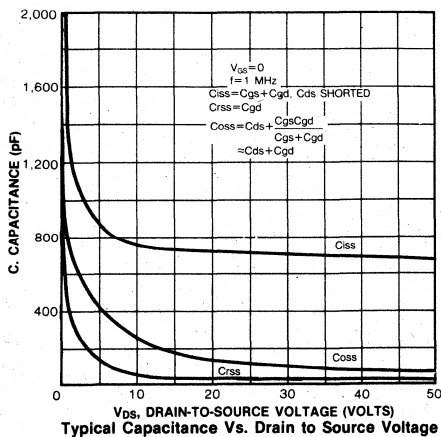
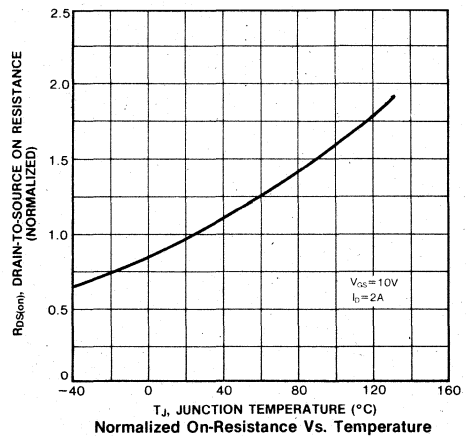
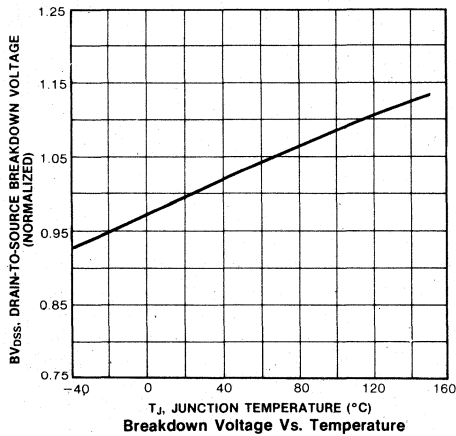
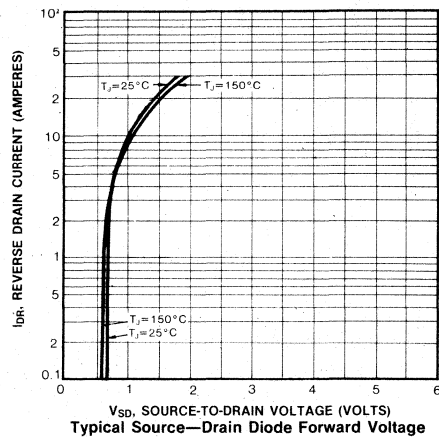
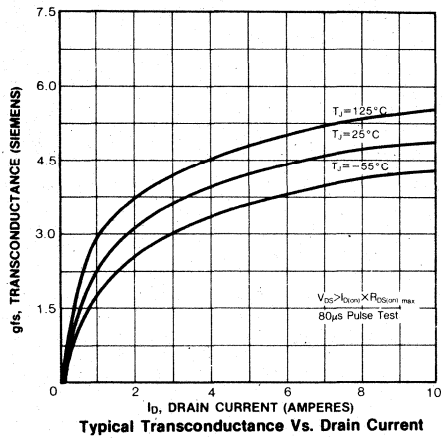

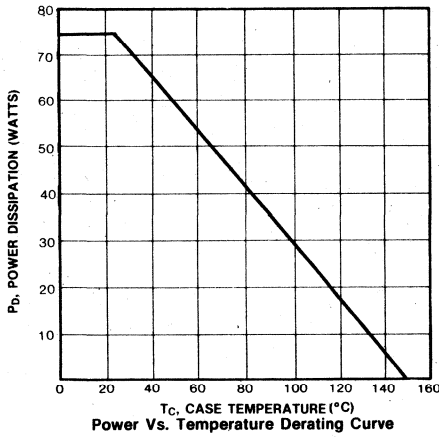
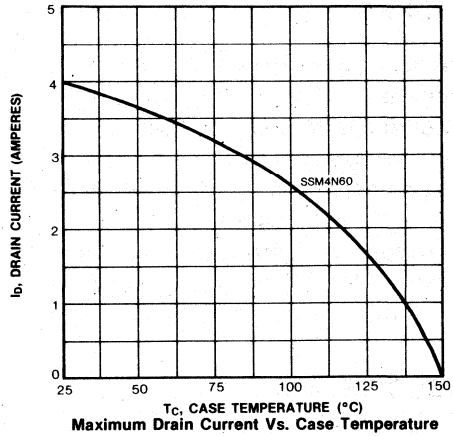
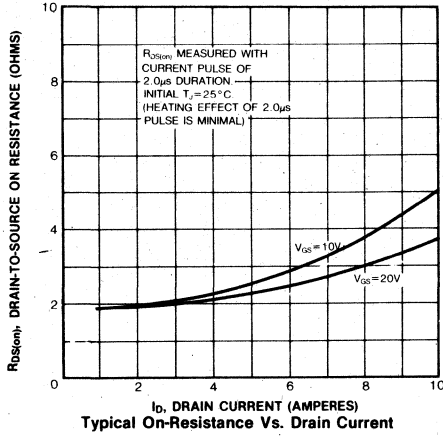

FEATURES

- Low $R_{DS(on)}$ at high voltage
- Improved inductive ruggedness
- Excellent high voltage stability
- Fast switching times
- Rugged polysilicon gate cell structure
- Low input capacitance
- Extended safe operating area
- Improved high temperature reliability
- TO-3 package (High voltage)

PRODUCT SUMMARY

Part Number	V_{DS}	$R_{DS(on)}$	I_D
SSM4N70	700V	2.5 Ω	4.0A

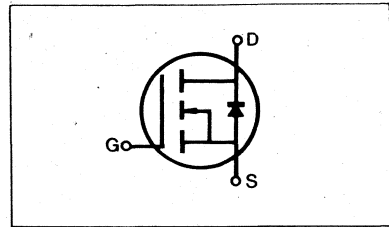
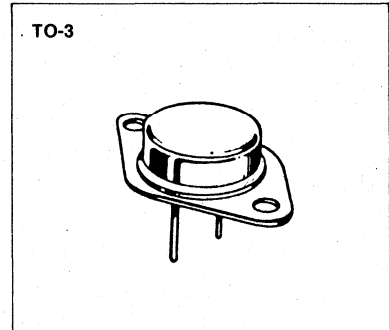

MAXIMUM RATINGS

Characteristic	Symbol	SSM4N70	Unit
Drain-Source Voltage (1)	V_{DSS}	700	Vdc
Drain-Gate Voltage ($R_{GS} = 1.0M\Omega$) (1)	V_{DGR}	700	Vdc
Gate-Source Voltage	V_{GS}	± 20	Vdc
Continuous Drain Current $T_C = 25^\circ C$	I_D	4.0	Adc
Continuous Drain Current $T_C = 100^\circ C$	I_D	2.5	Adc
Drain Current—Pulsed (3)	I_{DM}	16	Adc
Gate Current—Pulsed	I_{GM}	± 1.5	Adc
Total Power Dissipation @ $T_C = 25^\circ C$ Derate above $25^\circ C$	P_D	125 1.0	Watts W/ $^\circ C$
Operating and Storage Junction Temperature Range	T_J, T_{stg}	-55 to 150	$^\circ C$
Maximum Lead Temp. for Soldering Purposes, 1/8" from case for 5 seconds	T_L	300	$^\circ C$

Notes: (1) $T_J = 25^\circ C$ to $150^\circ C$

(2) Pulse test: Pulse width $\leq 300\mu s$, Duty Cycle $\leq 2\%$

(3) Repetitive rating: Pulse width limited by max. junction temperature

ELECTRICAL CHARACTERISTICS (T_C=25°C unless otherwise specified)

Characteristic	Symbol	Type	Min	Typ	Max	Units	Test Conditions
Drain-Source Breakdown Voltage	BV _{DSS}	ALL	700	—	—	V	V _{GS} =0V I _D =250μA
Gate Threshold Voltage	V _{GS(th)}	ALL	2.0	—	4.5	V	V _{DS} =V _{GS} , I _D =250μA
Gate-Source Leakage Forward	I _{GSS}	ALL	—	—	100	nA	V _{GS} =20V
Gate-Source Leakage Reverse	I _{GSS}	ALL	—	—	-100	nA	V _{GS} =20V
Zero Gate Voltage Drain Current	I _{DSS}	ALL	—	—	250	μA	V _{DS} =Max. Rating, V _{GS} =0V
			—	—	1000	μA	V _{DS} =Max. Rating×0.8, V _{GS} =0V, T _C =125°C
On-State Drain-Source Current (2)	I _{D(on)}	ALL	4.0			A	V _{DS} >I _{D(on)} ×R _{DS(on)} max., V _{GS} =10V
Static Drain-Source On-State Resistance (2)	R _{DS(on)}	ALL	—	2.25	2.5	Ω	V _{GS} =10V, I _D =2.0A
Forward Transconductance (2)	g _{fs}	ALL	2.5	3.6	—	S	V _{DS} >I _{D(on)} ×R _{DS(on)} max., I _D =2.0A
Input Capacitance	C _{iss}	ALL	—	—	1800	pF	V _{GS} =0V, V _{DS} =25V, f=1.0MHz
Output Capacitance	C _{oss}	ALL	—	1120	200	pF	
Reverse Transfer Capacitance	C _{rss}	ALL	—	70	75	pF	
Turn-On Delay Time	t _{d(on)}	ALL	—	—	60	ns	V _{DD} =0.5BV _{DSS} , I _D =2.0A, Z _O =4.7Ω (MOSFET switching times are essentially independent of operating temperature.)
Rise Time	t _r	ALL	—	—	150	ns	
Turn-Off Delay Time	t _{d(off)}	ALL	—	—	300	ns	
Fall Time	t _f	ALL	—	—	130	ns	
Total Gate Charge (Gate-Source Plus Gate-Drain)	Q _g	ALL	—	—	40	nC	V _{GS} =10V, I _D =5.0A, V _{DS} =0.8 Max. Rating (Gate charge is essentially independent of operating temperature.)
Gate-Source Charge	Q _{gs}	ALL	—	—	15	nC	
Gate-Drain ("Miller") Charge	Q _{gd}	ALL	—	—	25	nC	

THERMAL RESISTANCE

Junction-to-Case	R _{thJC}	ALL	—	—	1.0	K/W	
Case-to-Sink	R _{thCS}	ALL	—	0.1	—	K/W	Mounting surface flat, smooth, and greased
Junction-to-Ambient	R _{thJA}	ALL	—	—	30.0	K/W	Free Air Operation

SOURCE-DRAIN DIODE RATINGS AND CHARACTERISTICS

Characteristic	Symbol	Type	Min	Typ	Max	Units	Test Conditions
Continuous Source Current (Body Diode)	I _S	ALL	—	—	4.0	A	Modified MOSFET symbol showing the integral reverse P-N junction rectifier 
Pulse Source Current (Body Diode) (3)	I _{SM}	ALL	—	—	16.0	A	
Diode Forward Voltage (2)	V _{SD}	ALL	—	—	1.5	V	T _C =25°C, I _S =4.0A, V _{GS} =0V
Reverse Recovery Time	t _{rr}	ALL	—	600	—	ns	T _J =150°C, I _F =4.0A, dI _F /dt=100A/μs

Notes: (1) T_J=25°C to 150°C

(2) Pulse test: Pulse width≤300μs, Duty Cycle≤2%

(3) Repetitive rating: Pulse width limited by max. junction temperature

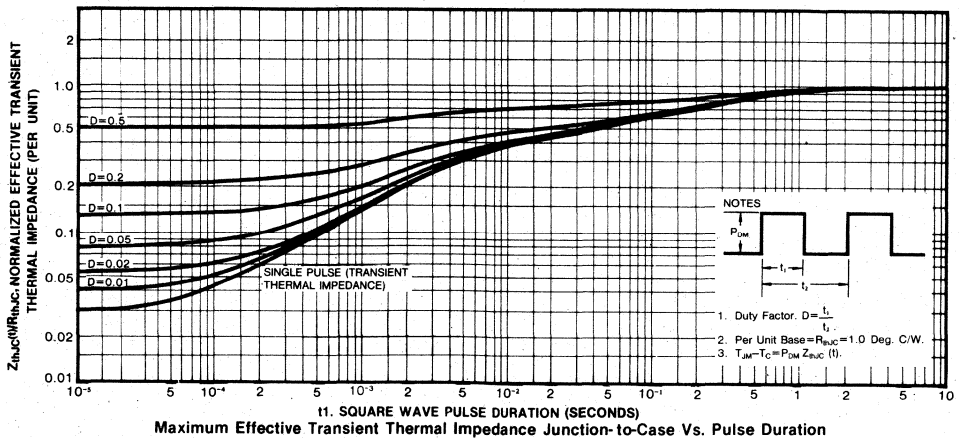
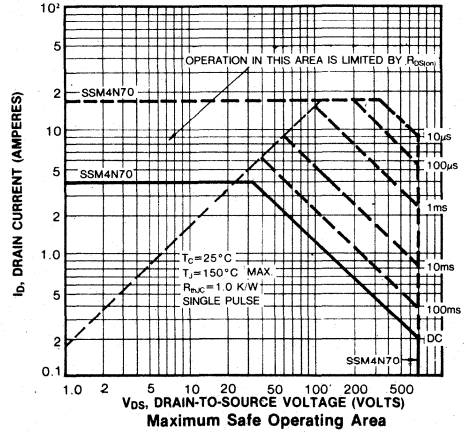
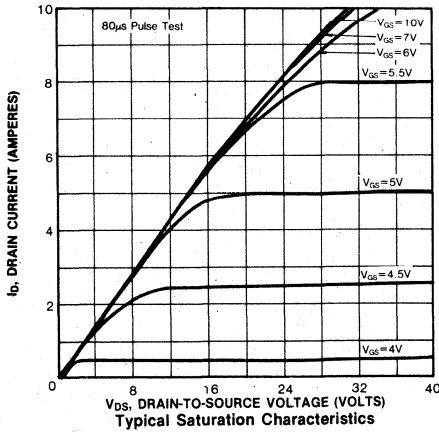
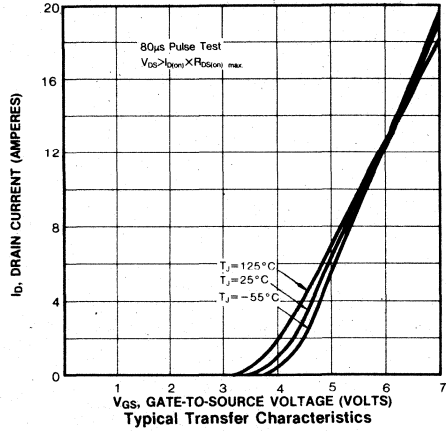
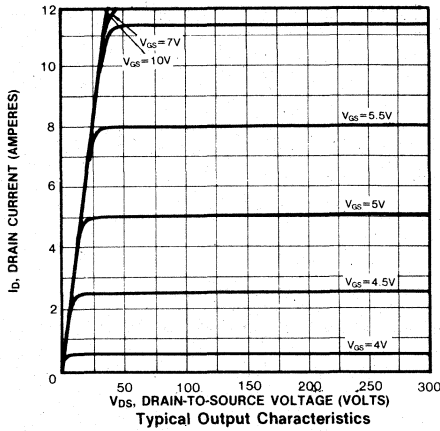

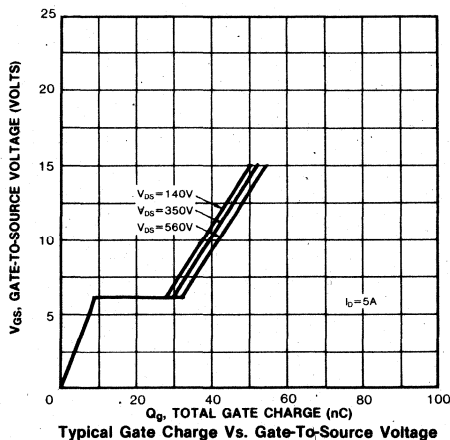
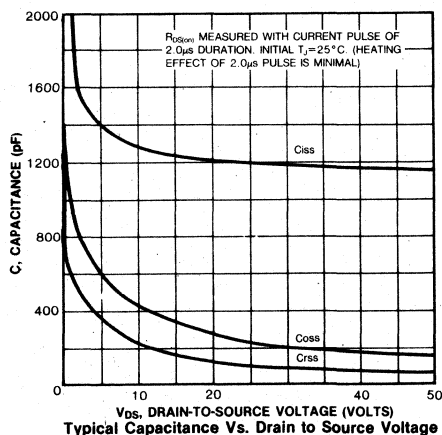
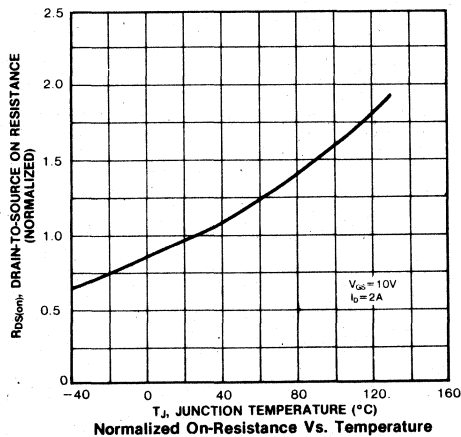
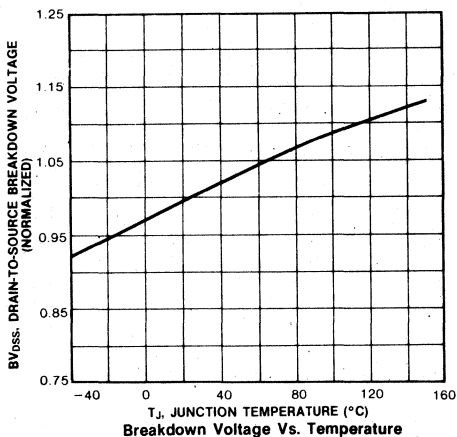
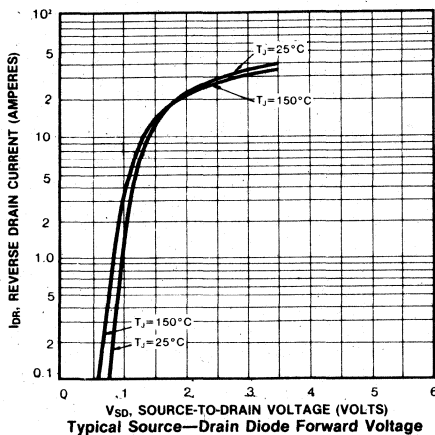
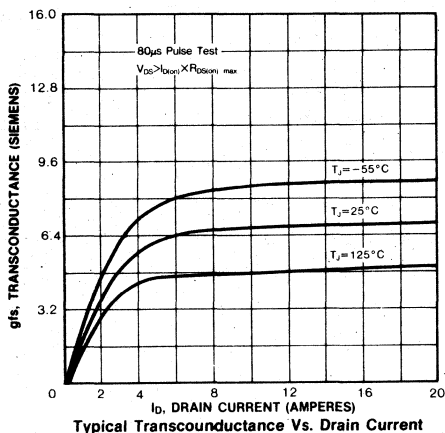

SSM4N70

N-CHANNEL POWER MOSFETS

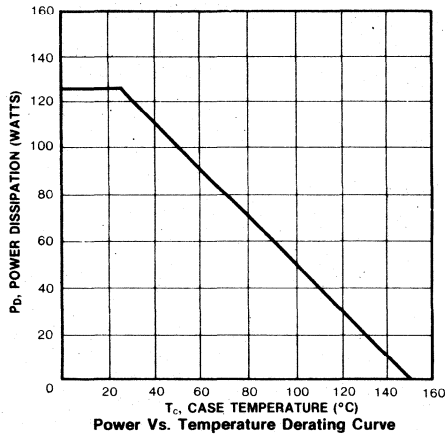
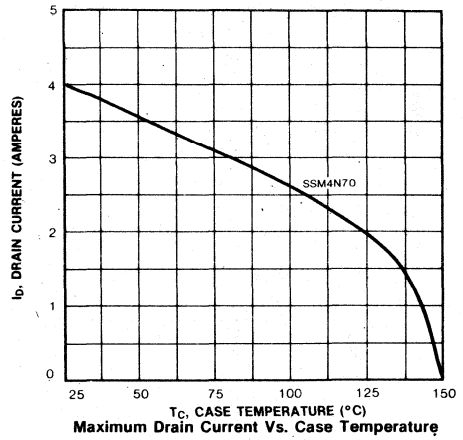
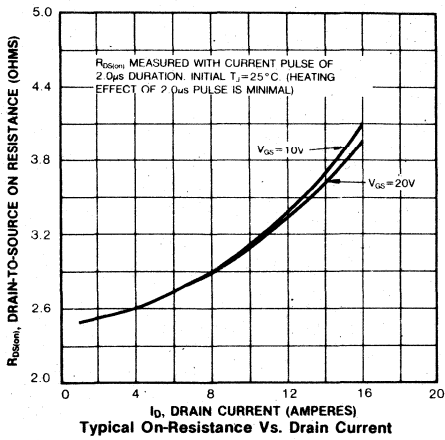

4

FEATURES

- Low $R_{DS(on)}$ at high voltage
- Improved inductive ruggedness
- Excellent high voltage stability
- Fast switching times
- Rugged polysilicon gate cell structure
- Low input capacitance
- Extended safe operating area
- Improved high temperature reliability
- TO-3 package (High voltage)

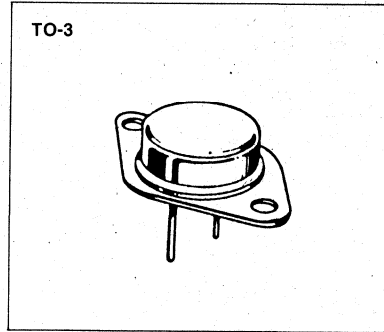

PRODUCT SUMMARY

Part Number	V_{DS}	$R_{DS(on)}$	I_D
SSM6N55	550V	$1.8\ \Omega$	6.0A
SSM6N60	600V	$1.8\ \Omega$	6.0A

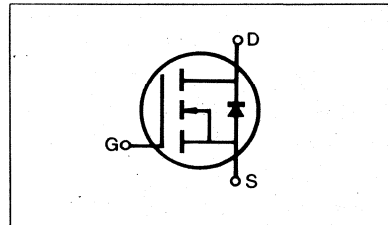

MAXIMUM RATINGS

Characteristic	Symbol	SSM6N55	SSM6N60	Unit
Drain-Source Voltage (1)	V_{DSS}	550	600	Vdc
Drain-Gate Voltage ($R_{GS}=1.0M\Omega$)(1)	V_{DGR}	550	600	Vdc
Gate-Source Voltage	V_{GS}	± 20		Vdc
Continuous Drain Current $T_C=25^\circ C$	I_D	6.0	6.0	Adc
Continuous Drain Current $T_C=100^\circ C$	I_D	4.0	4.0	Adc
Drain Current—Pulsed (3)	I_{DM}	24	24	Adc
Gate Current—Pulsed	I_{GM}	± 1.5		Adc
Total Power Dissipation @ $T_C=25^\circ C$ Derate above $25^\circ C$	P_D	125 1.0		Watts W/ $^\circ C$
Operating and Storage Junction Temperature Range	T_J, T_{stg}	-55 to 150		$^\circ C$
Maximum Lead Temp. for Soldering Purposes, 1/8" from case for 5 seconds	T_L	300		$^\circ C$

- Notes: (1) $T_J=25^\circ C$ to $150^\circ C$
 (2) Pulse test: Pulse width $\leq 300\mu s$, Duty Cycle $\leq 2\%$
 (3) Repetitive rating: Pulse width limited by max. junction temperature

ELECTRICAL CHARACTERISTICS (T_C=25°C unless otherwise specified)

Characteristic	Symbol	Type	Min	Typ	Max	Units	Test Conditions
Drain-Source Breakdown Voltage	BV _{DSS}	SSM6N55	550	—	—	V	V _{GS} =0V
		SSM6N55	600	—	—	V	I _D =250μA
Gate Threshold Voltage	V _{GS(th)}	ALL	2.0	—	4.5	V	V _{DS} =V _{GS} , I _D =250μA
Gate-Source Leakage Forward	I _{GSS}	ALL	—	—	100	nA	V _{GS} =20V
Gate-Source Leakage Reverse	I _{GSS}	ALL	—	—	-100	nA	V _{GS} =20V
Zero Gate Voltage Drain Current	I _{DSS}	ALL	—	—	250	μA	V _{DS} =Max., Rating=0.85 V _{GS} =0V
			—	—	1000	μA	V _{DS} =Max., Rating×0.8, V _{GS} =0V, T _C =125°C
On-State Drain-Source	I _{D(on)}	ALL	6.0	—	—	A	V _{DS} >I _{D(on)} ×R _{DS(on)} max., V _{GS} =10V
Static Drain-Source On-State Resistance (2)	R _{DS(on)}	ALL	—	1.15	1.8	Ω	V _{GS} =10V I _D =3.0A
Forward Transconductance (2)	g _{fs}	ALL	3.0	4.8	—	S	V _{DS} >I _{D(on)} ×R _{DS(on)} max., I _D =3.0A
Input Capacitance	C _{iss}	ALL	—	1100	1800	pF	
Output Capacitance	C _{oss}	ALL	—	170	350	pF	V _{GS} =0V, V _{DS} =25V, f=1.0MHz
Reverse Transfer Capacitance	C _{rss}	ALL	—	60	150	pF	
Turn-On Delay Time	t _{d(on)}	ALL	—	—	60	ns	
Rise Time	t _r	ALL	—	—	150	ns	V _{DD} =0.5BV _{DSS} , I _D =3.0A, Z _O =4.7Ω (MOSFET switching times are essentially independent of operating temperature.)
Turn-Off Delay Time	t _{d(off)}	ALL	—	—	200	ns	
Fall Time	t _f	ALL	—	—	120	ns	
Total Gate Charge (Gate-Source Plus Gate-Drain)	Q _g	ALL	—	—	40	nC	V _{GS} =10V, I _D =7.5A, V _{DS} =0.8 Max. Rating (Gate charge is essentially independent of operating temperature.)
Gate-Source Charge	Q _{gs}	ALL	—	—	15	nC	
Gate-Drain ("Miller") Charge	Q _{gd}	ALL	—	—	25	nC	

THERMAL RESISTANCE

Junction-to-Case	R _{thJC}	ALL	—	—	1.0	K/W	
Case-to-Sink	R _{thCS}	ALL	—	0.1	—	K/W	Mounting surface flat, smooth, and greased
Junction-to-Ambient	R _{thJA}	ALL	—	—	30	K/W	Free Air Operation

SOURCE-DRAIN DIODE RATINGS AND CHARACTERISTICS

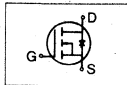
Continuous Source Current (Body Diode)	I _S	ALL	—	—	6.0	A	Modified MOSFET symbol showing the integral reverse P-N junction rectifier	
Pulse Source Current (Body Diode) (3)	I _{SM}	ALL	—	—	24.0	A		
Diode Forward Voltage (2)	V _{SD}	ALL	—	—	1.5	V	T _C =25°C, I _S =6.0A, V _{GS} =0V	
Reverse Recovery Time	t _{rr}	ALL	—	800	—	ns	T _J =150°C, I _F =6.0A, dI _F /dt=100A/μs	

Notes: (1) T_J=25°C to 150°C.

(2) Pulse test: Pulse width≤300μs, Duty Cycle≤2%

(3) Repetitive rating: Pulse width limited by max. junction temperature

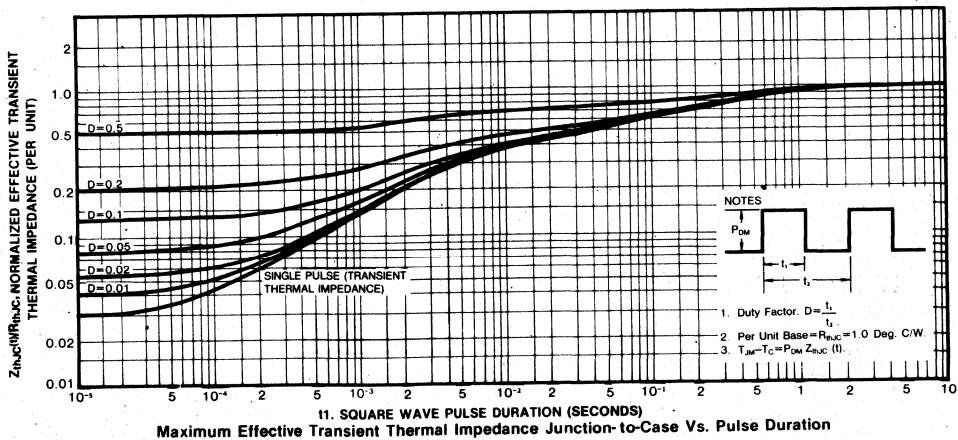
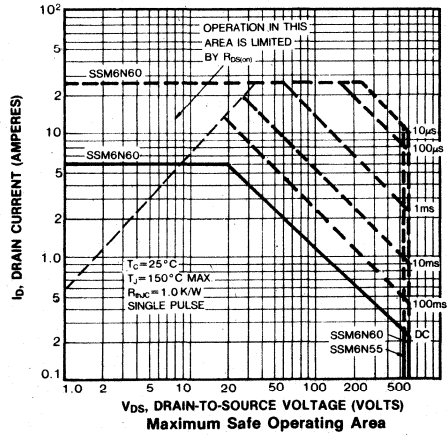
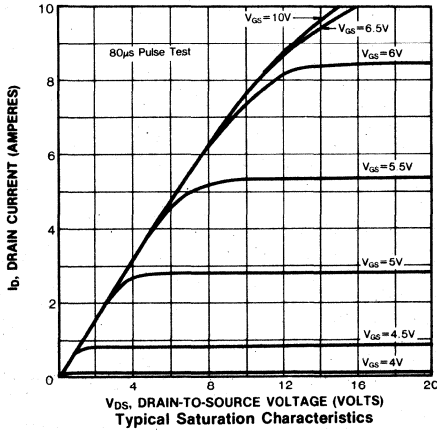
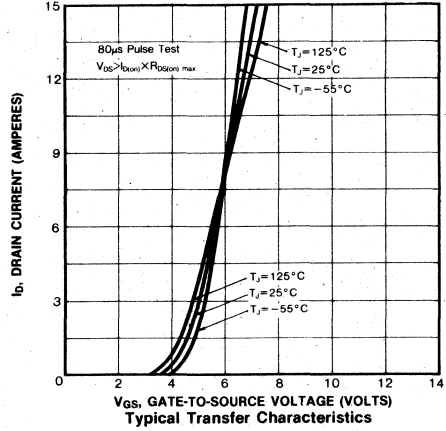
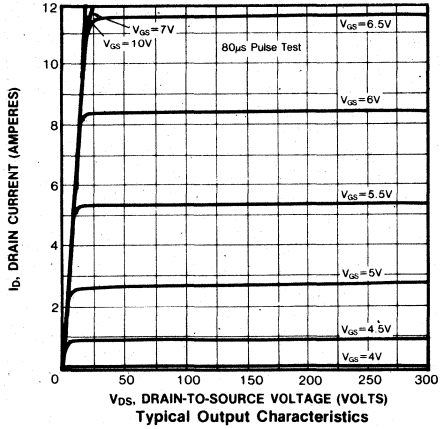

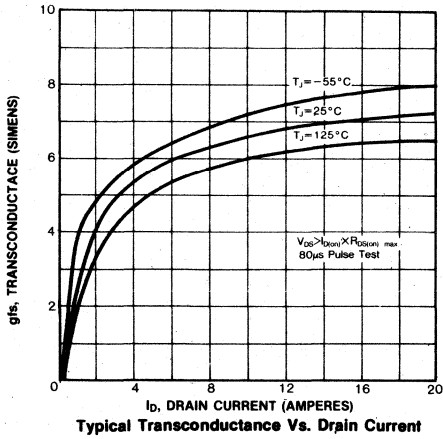

Typical Transconductance vs. Drain Current

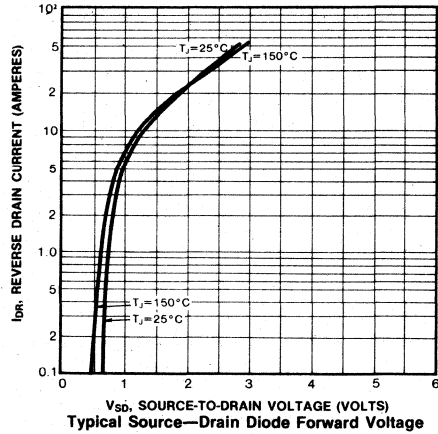

Typical Source-Drain Diode Forward Voltage

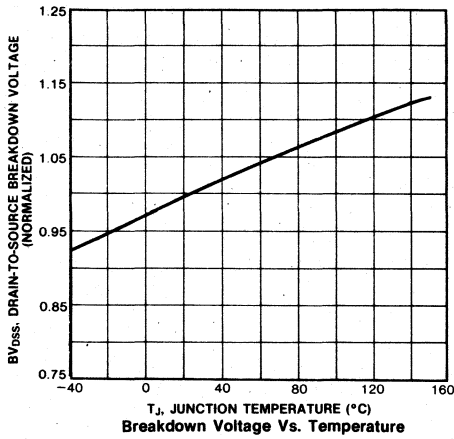

Breakdown Voltage vs. Temperature

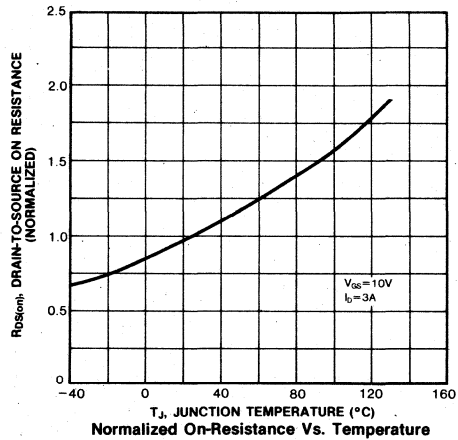

Normalized On-Resistance vs. Temperature

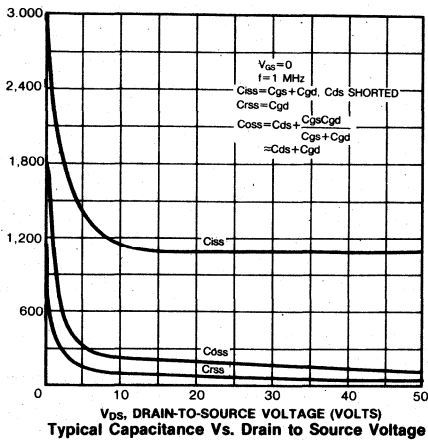

Typical Capacitance vs. Drain to Source Voltage

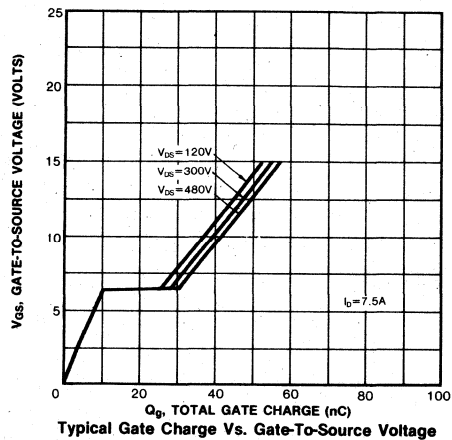

Typical Gate Charge vs. Gate-To-Source Voltage

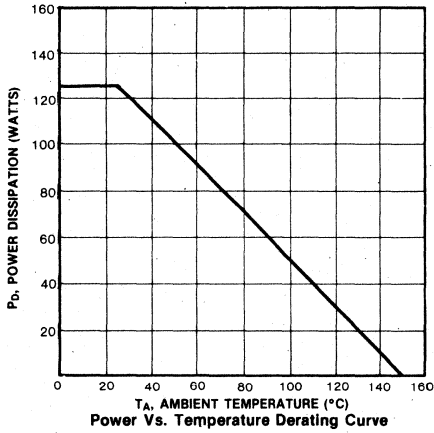
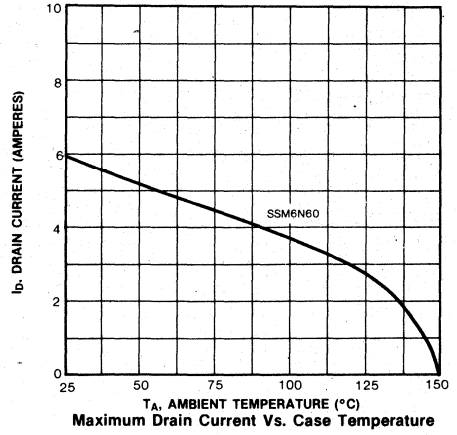
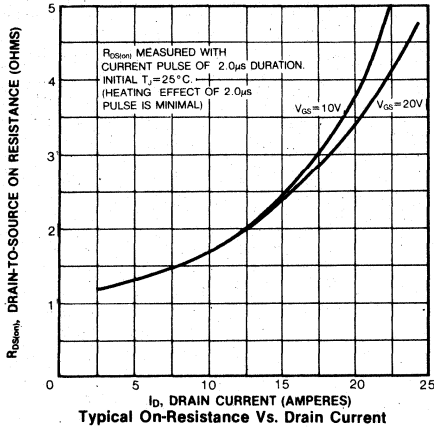

FEATURES

- Low $R_{DS(on)}$ at high voltage
- Improved inductive ruggedness
- Excellent high voltage stability
- Fast switching times
- Rugged polysilicon gate cell structure
- Low input capacitance
- Extended safe operating area
- Improved high temperature reliability
- TO-3 package (High voltage)

PRODUCT SUMMARY

Part Number	V_{DS}	$R_{DS(on)}$	I_D
SSM6N70	700V	1.4 Ω	6A

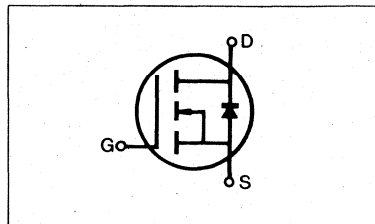
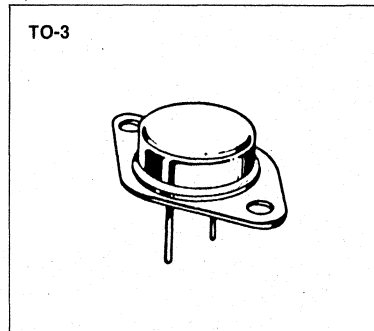

4

MAXIMUM RATINGS

Characteristic	Symbol	SSM6N70	Unit
Drain-Source Voltage (1)	V_{DSS}	700	Vdc
Drain-Gate Voltage ($R_{GS}=1.0M\Omega$) (1)	V_{DGR}	700	Vdc
Gate-Source Voltage	V_{GS}	± 20	Vdc
Continuous Drain Current $T_C=25^\circ C$	I_D	6	Adc
Continuous Drain Current $T_C=100^\circ C$	I_D	4.0	Adc
Drain Current—Pulsed (3)	I_{DM}	24	Adc
Gate Current—Pulsed	I_{GM}	± 1.5	Adc
Total Power Dissipation @ $T_C=25^\circ C$	P_D	150	Watts
Derate above $25^\circ C$		1.2	W/ $^\circ C$
Operating and Storage Junction Temperature Range	T_J, T_{stg}	-55 to 150	$^\circ C$
Maximum Lead Temp. for Soldering Purposes, 1/8" from case for 5 seconds	T_L	300	$^\circ C$

- Notes: (1) $T_J=25^\circ C$ to $150^\circ C$
 (2) Pulse test: Pulse width $\leq 300\mu s$, Duty Cycle $\leq 2\%$
 (3) Repetitive rating: Pulse width limited by max. junction temperature

ELECTRICAL CHARACTERISTICS (T_C=25°C unless otherwise specified)

Characteristic	Symbol	Type	Min	Typ	Max	Units	Test Conditions
Drain-Source Breakdown Voltage	BV _{DSS}	ALL	700	—	—	V	V _{GS} =0V I _D =250μA
Gate Threshold Voltage	V _{GS(th)}	ALL	2.0	—	4.5	V	V _{DS} =V _{GS} , I _D =250μA
Gate-Source Leakage Forward	I _{GSS}	ALL	—	—	100	nA	V _{GS} =20V
Gate-Source Leakage Reverse	I _{GSS}	ALL	—	—	-100	nA	V _{GS} =-20V
Zero Gate Voltage Drain Current	I _{DSS}	ALL	—	—	250	μA	V _{DS} =Max. Rating, V _{GS} =0V
			—	—	1000	μA	V _{DS} =Max. Rating×0.8, V _{GS} =0V, T _C =125°C
On-State Drain-Source Current (2)	I _{D(on)}	ALL	6.0	—	—	A	V _{DS} >I _{D(on)} ×R _{DS(on)} max., V _{GS} =10V
Static Drain-Source On-State Resistance (2)	R _{DS(on)}	ALL	—	1.0	1.4	Ω	V _{GS} =10V, I _D =3.0A
Forward Transconductance (2)	g _{fs}	ALL	5.0	7.0	—	S	V _{DS} >I _{D(on)} ×R _{DS(on)} max., I _D =3.0A
Input Capacitance	C _{iss}	ALL	—	2300	2800	pF	V _{GS} =0V, V _{DS} =25V, f=1.0MHz
Output Capacitance	C _{oss}	ALL	—	200	250	pF	
Reverse Transfer Capacitance	C _{rss}	ALL	—	50	100	pF	
Turn-On Delay Time	t _{d(on)}	ALL	—	—	90	ns	
Rise Time	t _r	ALL	—	—	200	ns	V _{DD} =0.5BV _{DSS} , I _D =3.0A, Z _O =4.7Ω (MOSFET switching times are essentially independent of operating temperature.)
Turn-Off Delay Time	t _{d(off)}	ALL	—	—	450	ns	
Fall Time	t _f	ALL	—	—	150	ns	
Total Gate Charge (Gate-Source Plus Gate-Drain)	Q _g	ALL	—	—	60	nC	V _{GS} =10V, I _D =7.5A, V _{DS} =0.8 Max. Rating (Gate charge is essentially independent of operating temperature.)
Gate-Source Charge	Q _{gs}	ALL	—	—	20	nC	
Gate-Drain ("Miller") Charge	Q _{gd}	ALL	—	—	40	nC	

THERMAL RESISTANCE

Junction-to-Case	R _{thJC}	ALL	—	—	0.83	K/W	
Case-to-Sink	R _{thCS}	ALL	—	0.1	—	K/W	Mounting surface flat, smooth, and greased
Junction-to-Ambient	R _{thJA}	ALL	—	—	30.0	K/W	Free Air Operation

SOURCE-DRAIN DIODE RATINGS AND CHARACTERISTICS

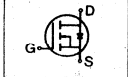
Characteristic	Symbol	Type	Min	Typ	Max	Units	Test Conditions
Continuous Source Current (Body Diode)	I _S	ALL	—	—	6.0	A	Modified MOSFET symbol ⁹ showing the integral reverse P-N junction rectifier 
Pulse Source Current (Body Diode) (1)	I _{SM}	ALL	—	—	24.0	A	
Diode Forward Voltage (2)	V _{SD}	ALL	—	—	1.5	V	T _C =25°C, I _S =6.0A, V _{GS} =0V
Reverse Recovery Time	t _{rr}	ALL	—	800	—	ns	T _J =150°C, I _F =8.0A, dI _F /dt=100A/μs

- Notes:** (1) T_J=25°C to 150°C
(2) Pulse test: Pulse width<300μs, Duty Cycle<2%
(3) Repetitive rating: Pulse width limited by max. junction temperature

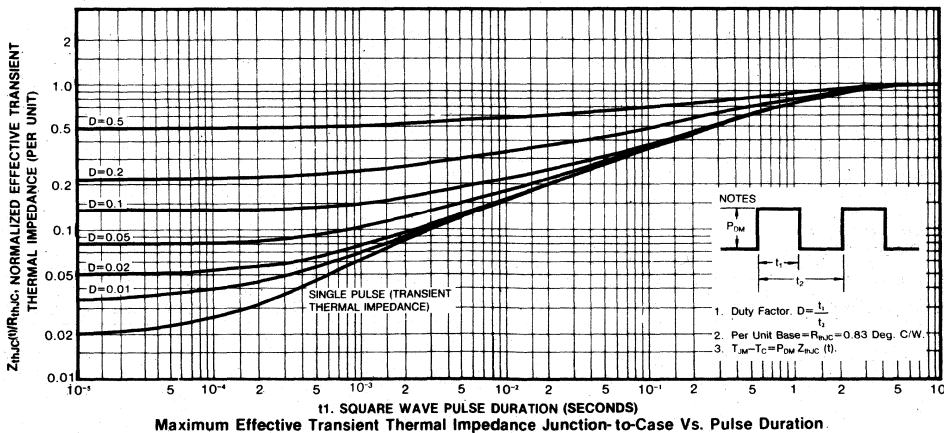
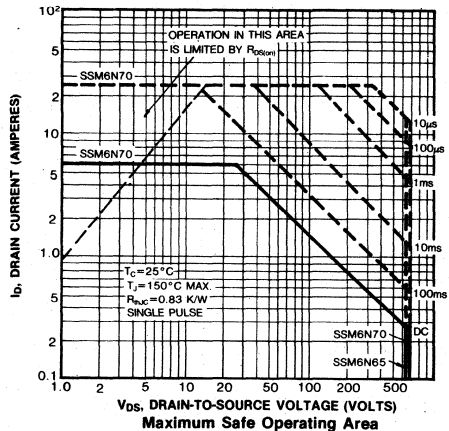
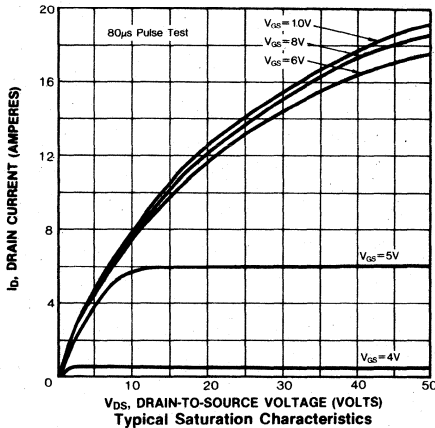
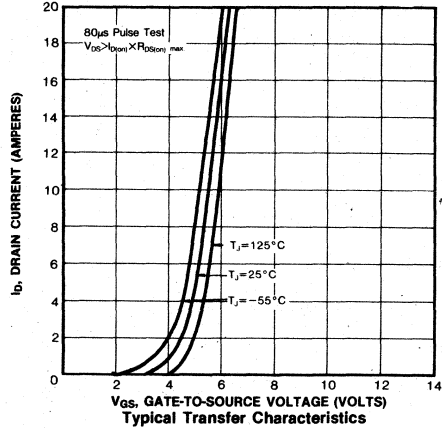
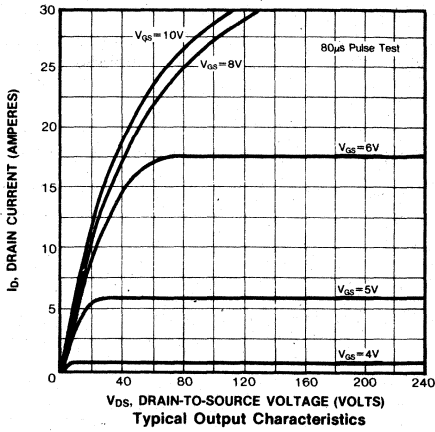

4

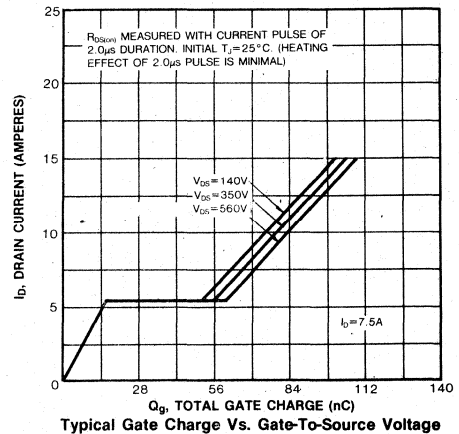
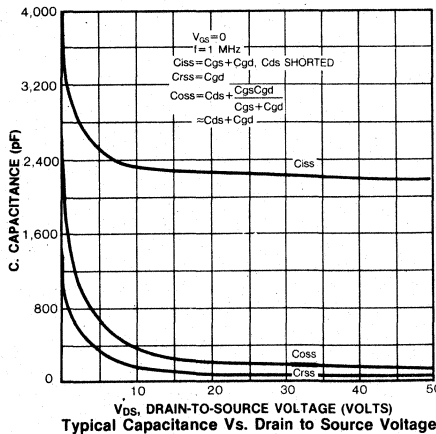
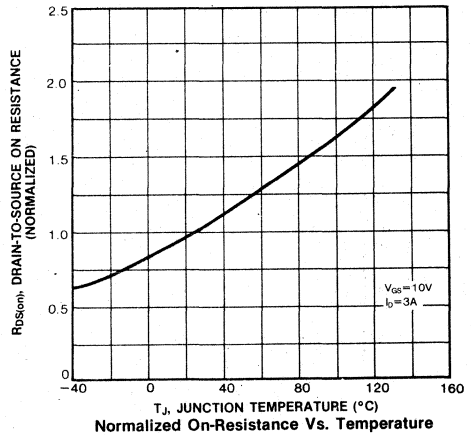
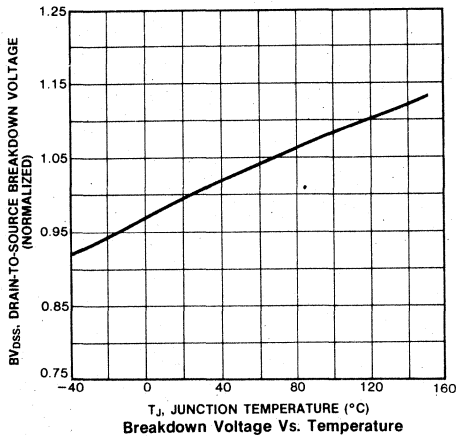
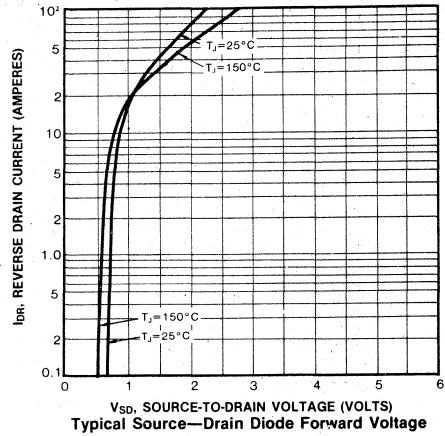
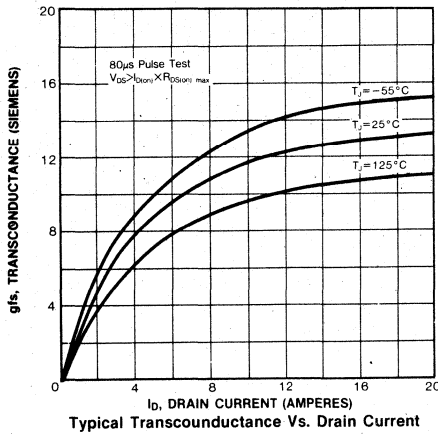

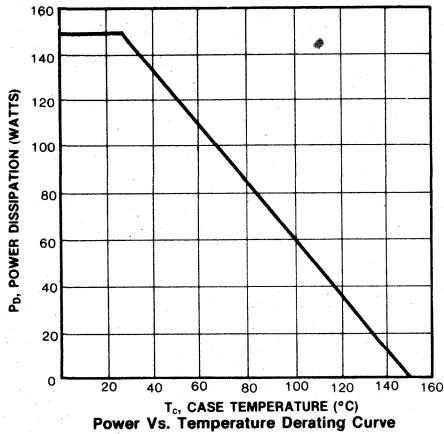
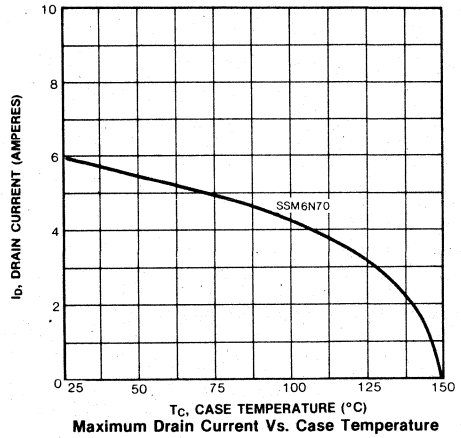
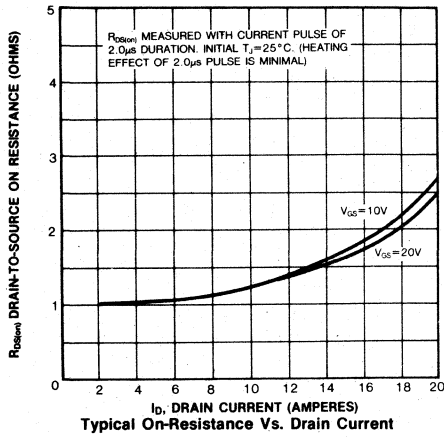

4

FEATURES

- Low $R_{DS(on)}$ at high voltage
- Improved inductive ruggedness
- Excellent high voltage stability
- Fast switching times
- Rugged polysilicon gate cell structure
- Low input capacitance
- Extended safe operating area
- Improved high temperature reliability
- TO-3 package (High voltage)

PRODUCT SUMMARY

Part Number	V_{DS}	$R_{DS(on)}$	I_D
SSM8N55	550V	1.0 Ω	8A
SSM8N60	600V	1.0 Ω	8A

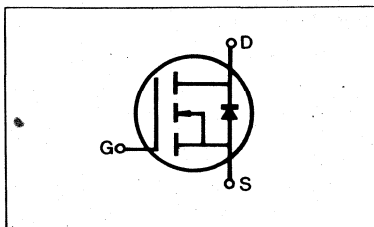
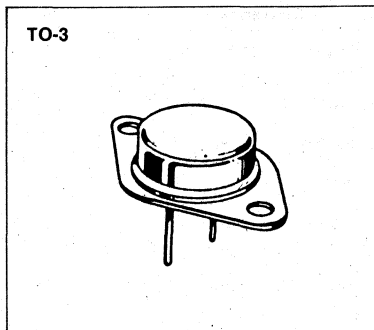

MAXIMUM RATINGS

Characteristic	Symbol	SSM8N55	SSM8N60	Unit
Drain-Source Voltage (1)	V_{DSS}	550	600	Vdc
Drain-Gate Voltage ($R_{GS}=1.0M\Omega$) (1)	V_{DGR}	550	600	Vdc
Gate-Source Voltage	V_{GS}	± 20		Vdc
Continuous Drain Current $T_C=25^\circ C$	I_D	8.0	8.0	Adc
Continuous Drain Current $T_C=100^\circ C$	I_D	5.0	5.0	Adc
Drain Current—Pulsed (3)	I_{DM}	32	32	Adc
Gate Current—Pulsed	I_{GM}	± 1.5		Adc
Total Power Dissipation @ $T_C=25^\circ C$ Derate above $25^\circ C$	P_D	150 1.2		Watts W/ $^\circ C$
Operating and Storage Junction Temperature Range	T_J, T_{stg}	-55 to 150		$^\circ C$
Maximum Lead Temp. for Soldering Purposes, 1/8" from case for 5 seconds	T_L	300		$^\circ C$

- Notes: (1) $T_J=25^\circ C$ to $150^\circ C$
 (2) Pulse test: Pulse width $\leq 300\mu s$, Duty Cycle $\leq 2\%$
 (3) Repetitive rating: Pulse width limited by max. junction temperature

ELECTRICAL CHARACTERISTICS ($T_C=25^\circ\text{C}$ unless otherwise specified)

Characteristic	Symbol	Type	Min	Typ	Max	Units	Test Conditions
Drain-Source Breakdown Voltage	V_{DSS}	S8M8N55	550	—	—	V	$V_{GS}=0V$
		S8M8N60	600	—	—	V	$I_D=250\mu A$
Gate Threshold Voltage	$V_{GS(th)}$	ALL	2.0	—	4.5	V	$V_{DS}=V_{GS}$, $I_D=250\mu A$
Gate-Source Leakage Forward	I_{GSS}	ALL	—	—	100	nA	$V_{GS}=20V$
Gate-Source Leakage Reverse	I_{GSS}	ALL	—	—	-100	nA	$V_{GS}=-20V$
Zero Gate Voltage Drain Current	I_{DSS}	ALL	—	—	250	μA	$V_{DS}=\text{Max. Rating}$, $V_{GS}=0V$
			—	—	1000	μA	$V_{DS}=\text{Max. Rating}\times 0.8$, $V_{GS}=0V$, $T_C=125^\circ\text{C}$
On-State Drain-Source Current (2)	$I_{D(on)}$	ALL	8.0	—	—	A	$V_{DS}>I_{D(on)}\times R_{DS(on)max}$, $V_{GS}=10V$
Static Drain-Source On-State Resistance (2)	$R_{DS(on)}$	ALL	—	0.7	1.0	Ω	$V_{GS}=10V$, $I_D=4.0A$
Forward Transconductance (2)	g_{fs}	ALL	5.0	5.5	—	S	$V_{DS}>I_{D(on)}\times R_{DS(on)max}$, $I_D=4.0A$
Input Capacitance	C_{iss}	ALL	—	2600	3000	pF	
Output Capacitance	C_{oss}	ALL	—	400	600	pF	$V_{GS}=0V$, $V_{DS}=25V$, $f=1.0\text{MHz}$
Reverse Transfer Capacitance	C_{rss}	ALL	—	130	200	pF	
Turn-On Delay Time	$t_{d(on)}$	ALL	—	—	90	ns	$V_{DD}=0.5V_{DSS}$, $I_D=4.0A$, $Z_O=4.7\Omega$ (MOSFET switching times are essentially independent of operating temperature.)
Rise Time	t_r	ALL	—	—	200	ns	
Turn-Off Delay Time	$t_{d(off)}$	ALL	—	—	450	ns	
Fall Time	t_f	ALL	—	—	150	ns	
Total Gate Charge (Gate-Source Plus Gate-Drain)	Q_g	ALL	—	—	120	nC	$V_{GS}=10V$, $I_D=10.0A$, $V_{DS}=0.8\text{Max.}$ Rating (Gate charge is essentially independent of operating temperature.)
Gate-Source Charge	Q_{gs}	ALL	—	—	40	nC	
Gate-Drain ("Miller") Charge	Q_{gd}	ALL	—	—	80	nC	

THERMAL RESISTANCE

Junction-to-Case	R_{thJC}	ALL	—	—	0.83	K/W	
Case-to-Sink	R_{thCS}	ALL	—	0.1	—	K/W	Mounting surface flat, smooth, and greased
Junction-to-Ambient	R_{thJA}	ALL	—	—	30.0	K/W	Free Air Operation

SOURCE-DRAIN DIODE RATINGS AND CHARACTERISTICS

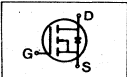
Characteristic	Symbol	Type	Min	Typ	Max	Units	Test Conditions
Continuous Source Current (Body Diode)	I_S	ALL	—	—	8.0	A	Modified MOSFET symbol showing the integral reverse P-N junction rectifier 
Pulse Source Current (Body Diode) (3)	I_{SM}	ALL	—	—	32.0	A	
Diode Forward Voltage (2)	V_{SD}	ALL	—	—	1.5	V	$T_C=25^\circ\text{C}$, $I_S=8.0A$, $V_{GS}=0V$
Reverse Recovery Time	t_{rr}	ALL	—	800	—	ns	$T_J=150^\circ\text{C}$, $I_F=8.0A$, $dI_F/dt=100A/\mu s$

Notes: (1) $T_J=25^\circ\text{C}$ to 150°C (2) Pulse test: Pulse width $\leq 300\mu s$, Duty Cycle $\leq 2\%$

(3) Repetitive rating: Pulse width limited by max. junction temperature

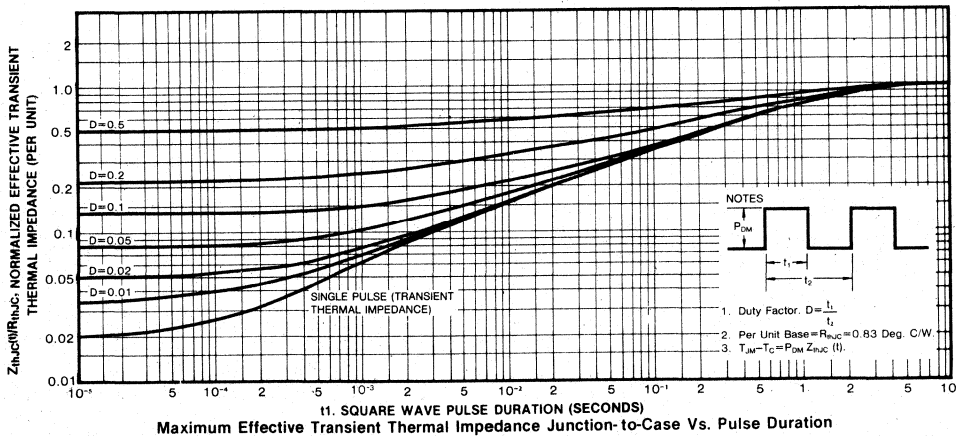
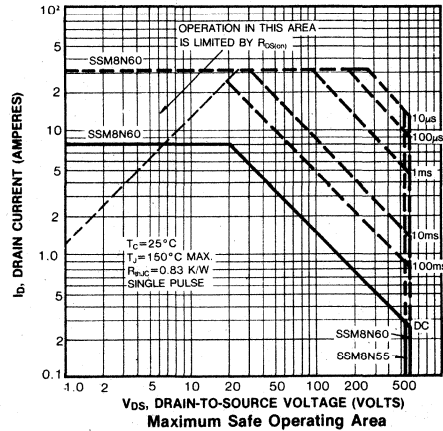
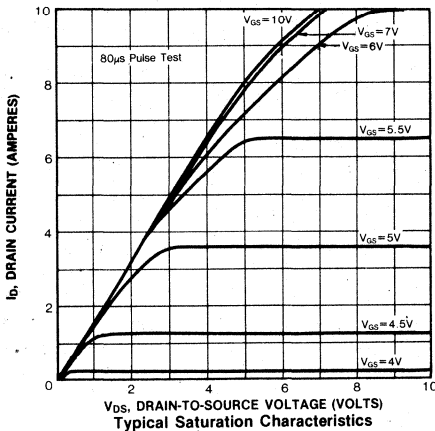
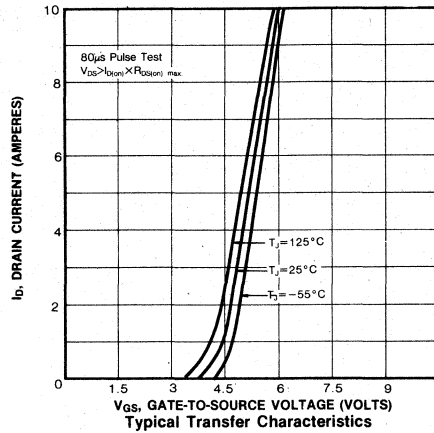
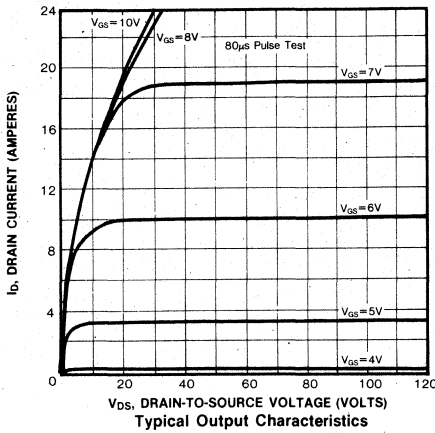

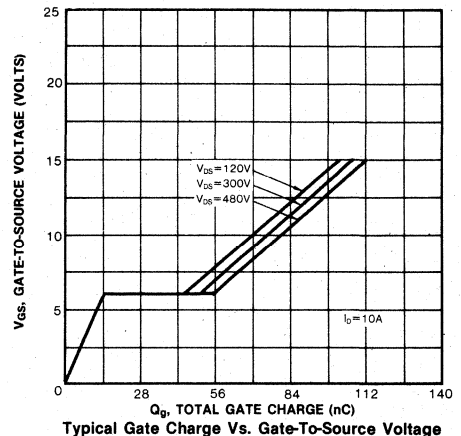
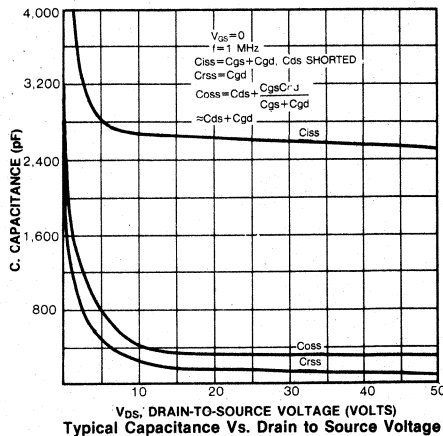
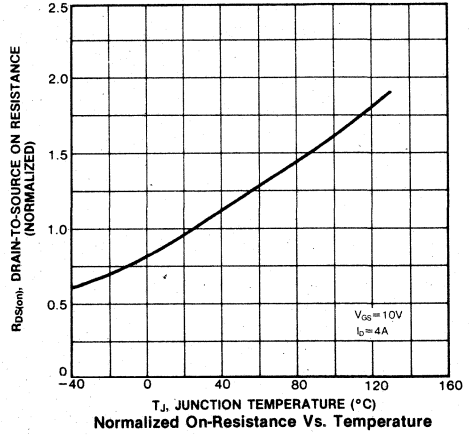
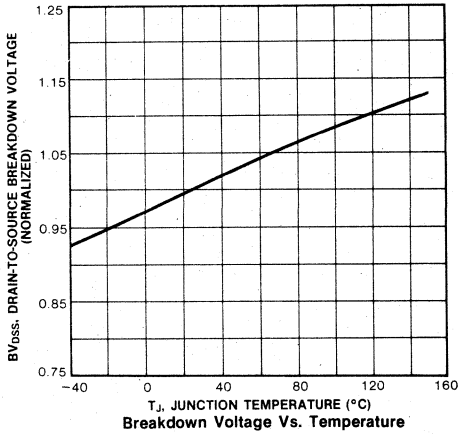
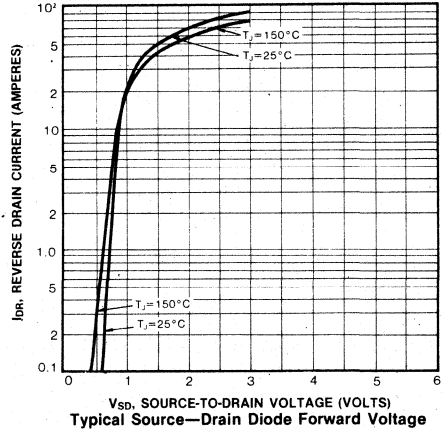
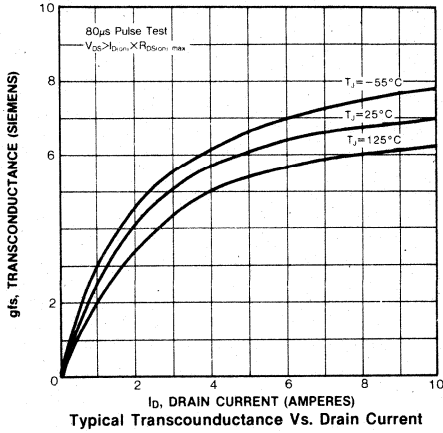

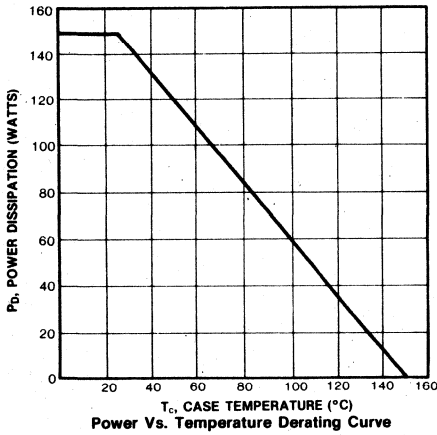
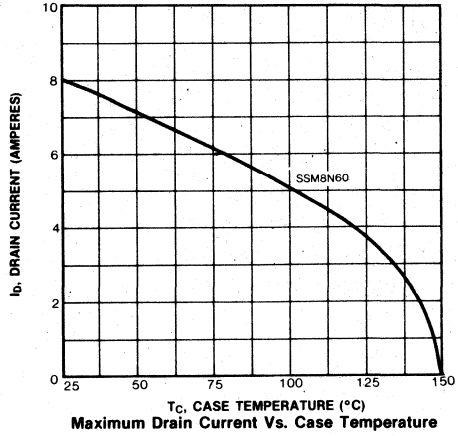
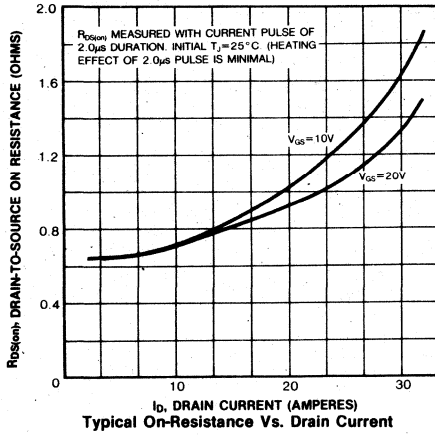

FEATURES

- Low $R_{DS(on)}$ at high voltage
- Improved inductive ruggedness
- Excellent high voltage stability
- Fast switching times
- Rugged polysilicon gate cell structure
- Low input capacitance
- Extended safe operating area
- Improved high temperature reliability
- TO-3P package

PRODUCT SUMMARY

Part Number	V_{DS}	$R_{DS(on)}$	I_D
SSH3N70	700V	5.0 Ω	3A

TO-3P

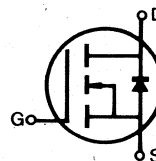
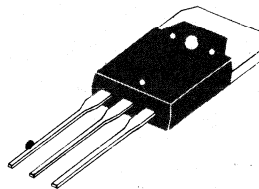

MAXIMUM RATINGS

Characteristic	Symbol	SSH3N70	Unit
Drain-Source Voltage (1)	V_{DSS}	700	Vdc
Drain-Gate Voltage ($R_{GS}=1.0M\Omega$) (1)	V_{DGR}	700	Vdc
Gate-Source Voltage	V_{GS}	± 20	Vdc
Continuous Drain Current $T_C=25^\circ C$	I_D	3	Adc
Continuous Drain Current $T_C=100^\circ C$	I_D	2	Adc
Drain Current—Pulsed (3)	I_{DM}	12	Adc
Gate Current—Pulsed	I_{GM}	± 1.5	Adc
Total Power Dissipation @ $T_C=25^\circ C$	P_D	75	Watts
Derate above $25^\circ C$		0.6	W/ $^\circ C$
Operating and Storage Junction Temperature Range	T_J, T_{stg}	-55 to 150	$^\circ C$
Maximum Lead Temp. for Soldering Purposes, 1/8" from case for 5 seconds	T_L	300	$^\circ C$

- Notes: (1) $T_J=25^\circ C$ to $150^\circ C$
 (2) Pulse test: Pulse width $\leq 300\mu s$, Duty Cycle $\leq 2\%$
 (3) Repetitive rating: Pulse width limited by max. junction temperature

ELECTRICAL CHARACTERISTICS (T_C=25°C unless otherwise specified)

Characteristic	Symbol	Type	Min	Typ	Max	Units	Test Conditions
Drain-Source Breakdown Voltage	BV _{DSS}	ALL	700	—	—	V	V _{GS} =0V I _D =250μA
Gate Threshold Voltage	V _{GS(th)}	ALL	2.0	—	4.5	V	V _{DS} =V _{GS} , I _D =250μA
Gate-Source Leakage Forward	I _{GSS}	ALL	—	—	100	nA	V _{GS} =20V
Gate-Source Leakage Reverse	I _{GSS}	ALL	—	—	-100	nA	V _{GS} =-20V
Zero Gate Voltage Drain Current	I _{DSS}	ALL	—	—	250	μA	V _{DS} =Max. Rating, V _{GS} =0V
			—	—	1000	μA	V _{DS} =Max. Rating×0.8, V _{GS} =0V, T _C =125°C
On-State Drain-Source Current (2)	I _{D(on)}	ALL	3.0	—	—	A	V _{DS} >I _{D(on)} ×R _{DS(on) max.} , V _{GS} =10V
Static Drain-Source On-State Resistance (2)	R _{DS(on)}	ALL	—	4.8	5.0	Ω	V _{GS} =10V, I _D =1.5A
Forward Transconductance (2)	g _{fs}	ALL	3.0	2.5	—	S	V _{DS} >I _{D(on)} ×R _{DS(on) max.} , I _D =1.5A
Input Capacitance	C _{iss}	ALL	—	730	900	pF	V _{GS} =0V, V _{DS} =25V, f=1.0MHz
Output Capacitance	C _{oss}	ALL	—	70	75	pF	
Reverse Transfer Capacitance	C _{rss}	ALL	—	20	25	pF	
Turn-On Delay Time	t _{d(on)}	ALL	—	—	40	ns	V _{DD} =0.5BV _{DSS} , I _D =1.5A, Z _O =15Ω (MOSFET switching times are essentially independent of operating temperature.)
Rise Time	t _r	ALL	—	—	95	ns	
Turn-Off Delay Time	t _{d(off)}	ALL	—	—	150	ns	
Fall Time	t _f	ALL	—	—	60	ns	
Total Gate Charge (Gate-Source Plus Gate-Drain)	Q _g	ALL	—	—	25	nC	V _{GS} =10V, I _D =4.0A, V _{DS} =0.8 Max. Rating (Gate charge is essentially independent of operating temperature.)
Gate-Source Charge	Q _{gs}	ALL	—	—	10	nC	
Gate-Drain ("Miller") Charge	Q _{gd}	ALL	—	—	15	nC	

THERMAL RESISTANCE

Junction-to-Case	R _{thJC}	ALL	—	—	1.67	K/W	
Case-to-Sink	R _{thCS}	ALL	—	0.1	—	K/W	Mounting surface flat, smooth, and greased
Junction-to-Ambient	R _{thJA}	ALL	—	—	80.0	K/W	Free Air Operation

SOURCE-DRAIN DIODE RATINGS AND CHARACTERISTICS

Continuous Source Current (Body Diode)	I _S	ALL	—	—	3.0	A	Modified MOSFET symbol showing the integral reverse P-N junction rectifier	
Pulse Source Current (Body Diode) (3)	I _{SM}	ALL	—	—	12.0	A		
Diode Forward Voltage (2)	V _{SD}	ALL	—	—	1.5	V	T _C =25°C, I _S =3.0A, V _{GS} =0V	
Reverse Recovery Time	t _{rr}	ALL	—	500	—	ns	T _J =150°C, I _F =3.0A, dI _F /dt=100A/μs	

- Notes: (1) T_J=25°C to 150°C
(2) Pulse test: Pulse width≤300μs, Duty Cycle≤2%
(3) Repetitive rating: Pulse width limited by max. junction temperature

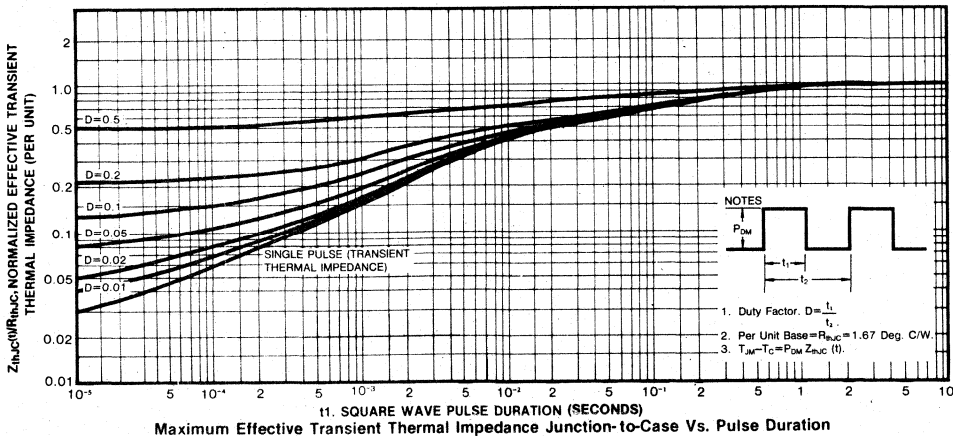
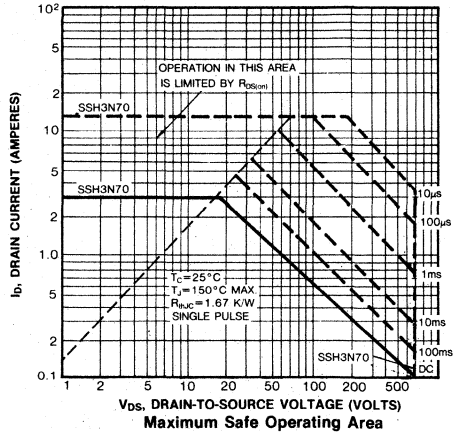
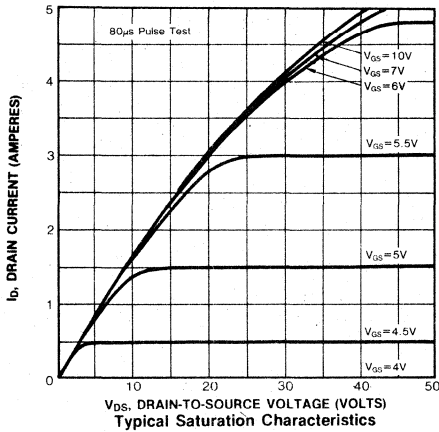
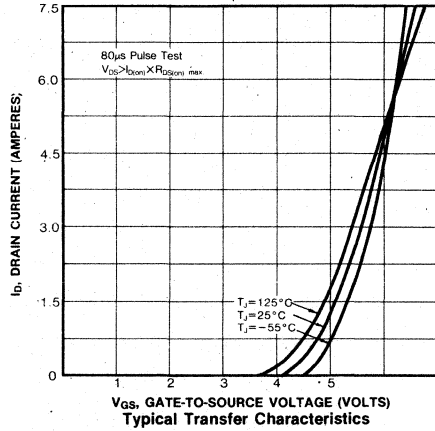
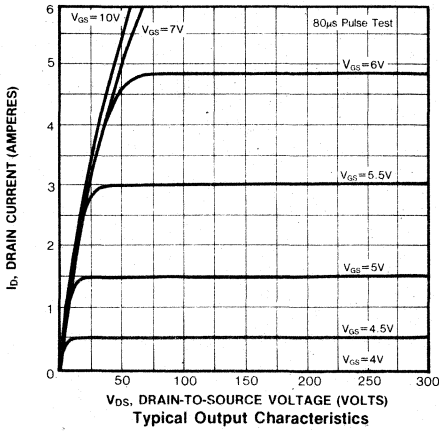

4

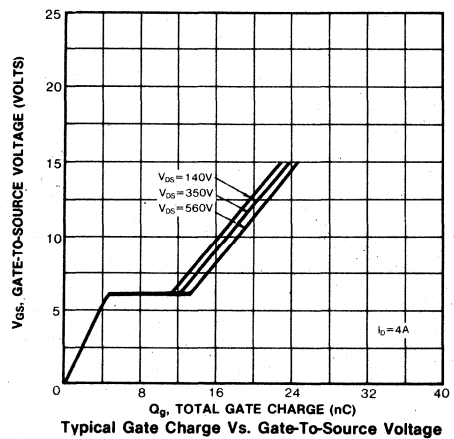
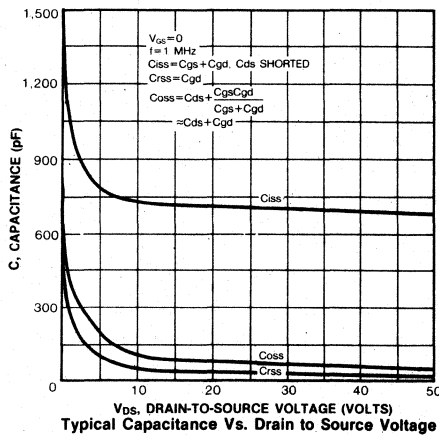
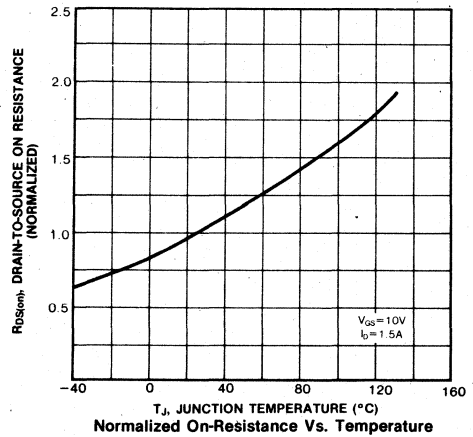
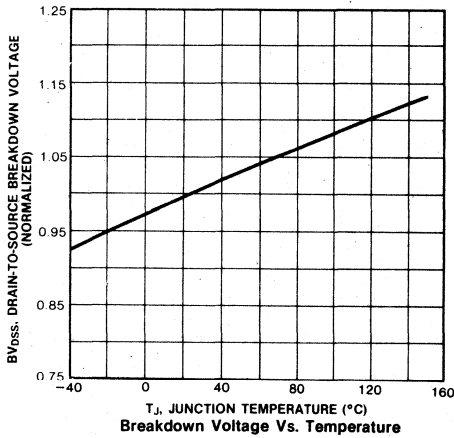
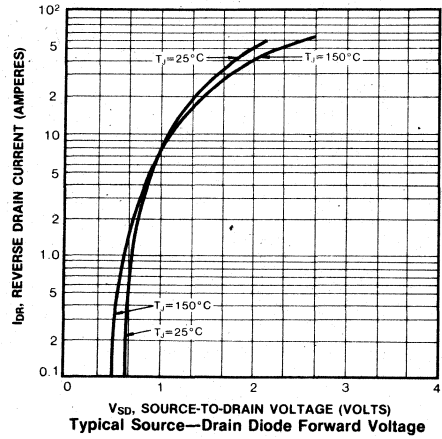
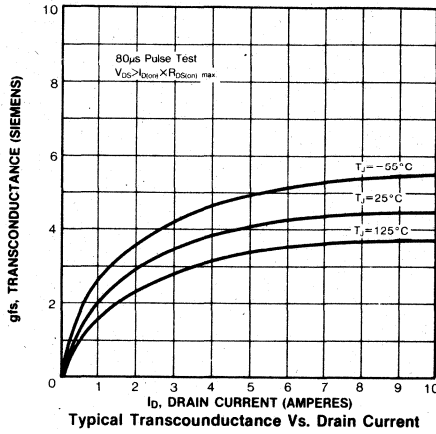

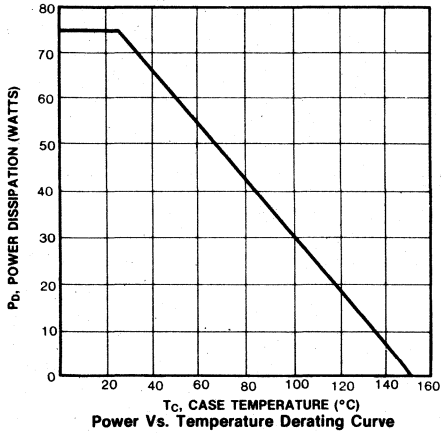
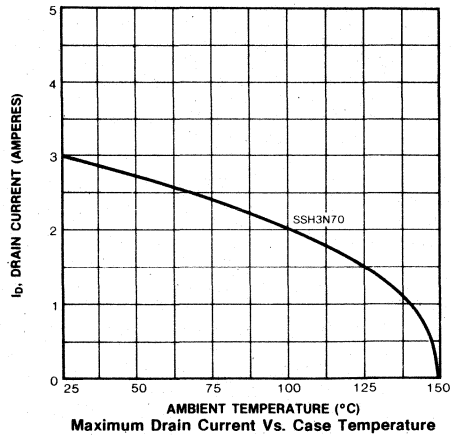
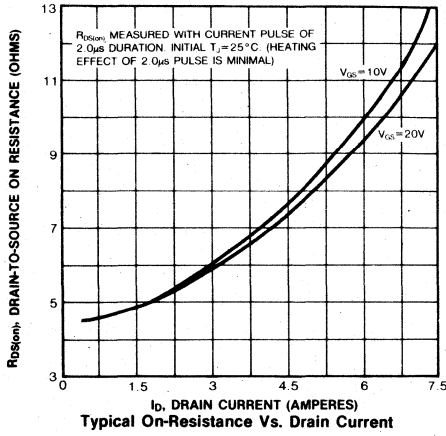

4

FEATURES

- Low $R_{DS(on)}$ at high voltage
- Improved inductive ruggedness
- Excellent high voltage stability
- Fast switching times
- Rugged polysilicon gate cell structure
- Low input capacitance
- Extended safe operating area
- Improved high temperature reliability
- TO-3P package

PRODUCT SUMMARY

Part Number	V_{DS}	$R_{DS(on)}$	I_D
SSH4N55	550V	$3.0\ \Omega$	4A
SSH4N60	600V	$3.0\ \Omega$	4A

TO-3P

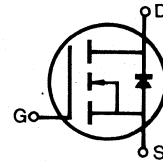
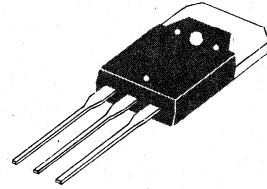

MAXIMUM RATINGS

Characteristic	Symbol	SSH4N55	SSH4N60	Unit
Drain-Source Voltage (1)	V_{DS}	550	600	Vdc
Drain-Gate Voltage ($R_{GS}=1.0M\Omega$) (1)	V_{DGR}	550	600	Vdc
Gate-Source Voltage	V_{GS}	± 20		Vdc
Continuous Drain Current $T_C=25^\circ\text{C}$	I_D	4.0	4.0	Adc
Continuous Drain Current $T_C=100^\circ\text{C}$	I_D	2.5	2.5	Adc
Drain Current—Pulsed (3)	I_{DM}	16	16	Adc
Gate Current—Pulsed	I_{GM}	± 1.5		Adc
Total Power Dissipation @ $T_C=25^\circ\text{C}$ Derate above 25°C	P_D	75 0.6		Watts W/ $^\circ\text{C}$
Operating and Storage Junction Temperature Range	T_J, T_{stg}	-55 to 150		$^\circ\text{C}$
Maximum Lead Temp. for Soldering Purposes, 1/8" from case for 5 seconds	T_L	300		$^\circ\text{C}$

Notes: (1) $T_J=25^\circ\text{C}$ to 150°C

(2) Pulse test: Pulse width $\leq 300\mu\text{s}$, Duty Cycle $\leq 2\%$

(3) Repetitive rating: Pulse width limited by max. junction temperature

ELECTRICAL CHARACTERISTICS (T_C=25°C unless otherwise specified)

Characteristic	Symbol	Type	Min	Typ	Max	Units	Test Conditions
Drain-Source Breakdown Voltage	BV _{DSS}	SSH4N55 SSH4N60	550 600	—	—	V	V _{GS} =0V I _D =250μA
Gate Threshold Voltage	V _{GS(th)}	ALL	2.0	—	4.5	V	V _{DS} =V _{GS} , I _D =250μA
Gate-Source Leakage Forward	I _{GSS}	ALL	—	—	100	nA	V _{GS} =20V
Gate-Source Leakage Reverse	I _{GSS}	ALL	—	—	-100	nA	V _{GS} =-20V
Zero Gate Voltage Drain Current	I _{DSS}	ALL	—	—	250	μA	V _{DS} =Max. Rating, V _{GS} =0V
			—	—	1000	μA	V _{DS} =Max. Rating×0.8, V _{GS} =0V, T _C =125°C
On-State Drain-Source Current (2)	I _{D(on)}	ALL	4.0	—	—	A	V _{DS} >I _{D(on)} ×R _{DS(on)} max., V _{GS} =10V
Static Drain-Source On-State Resistance (2)	R _{DS(on)}	ALL	—	2.0	3.0	Ω	V _{GS} =10V, I _D =2.0A
Forward Transconductance (2)	g _{fs}	ALL	2.0	3.1	—	♢	V _{DS} >I _{D(on)} ×R _{DS(on)} max., I _D =2.0A
Input Capacitance	C _{iss}	ALL	—	720	900	pF	V _{GS} =0V, V _{DS} =25V, f=1.0MHz
Output Capacitance	C _{oss}	ALL	—	110	200	pF	
Reverse Transfer Capacitance	C _{rss}	ALL	—	40	60	pF	
Turn-On Delay Time	t _{d(on)}	ALL	—	—	40	ns	V _{DD} =0.5BV _{DSS} , I _D =2.0A, Z _O =15Ω (MOSFET switching times are essentially independent of operating temperature.)
Rise Time	t _r	ALL	—	—	95	ns	
Turn-Off Delay Time	t _{d(off)}	ALL	—	—	150	ns	
Fall Time	t _f	ALL	—	—	60	ns	
Total Gate Charge (Gate-Source Plus Gate-Drain)	Q _g	ALL	—	—	25	nC	
Gate-Source Charge	Q _{gs}	ALL	—	—	10	nC	
Gate-Drain ("Miller") Charge	Q _{gd}	ALL	—	—	15	nC	

THERMAL RESISTANCE

Junction-to-Case	R _{thJC}	ALL	—	—	1.67	K/W	
Case-to-Sink	R _{thCS}	ALL	—	0.1	—	K/W	Mounting surface flat, smooth, and greased
Junction-to-Ambient	R _{thJA}	ALL	—	—	80.0	K/W	Free Air Operation

SOURCE-DRAIN DIODE RATINGS AND CHARACTERISTICS

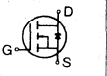
Characteristic	Symbol	Type	Min	Typ	Max	Units	Test Conditions
Continuous Source Current (Body Diode)	I _S	ALL	—	—	4.0	A	Modified MOSFET symbol showing the integral reverse P-N junction rectifier 
Pulse Source Current (Body Diode) (3)	I _{SM}	ALL	—	—	16.0	A	
Diode Forward Voltage (2)	V _{SD}	ALL	—	—	1.5	V	T _C =25°C, I _S =4.0A, V _{GS} =0V
Reverse Recovery Time	t _{rr}	ALL	—	600	—	ns	T _J =150°C, I _F =4.0A, dI _F /dt=100A/μs

Notes: (1) T_J=25°C to 150°C

(2) Pulse test: Pulse width≤300μs, Duty Cycle≤2%

(3) Repetitive rating: Pulse width limited by max. junction temperature

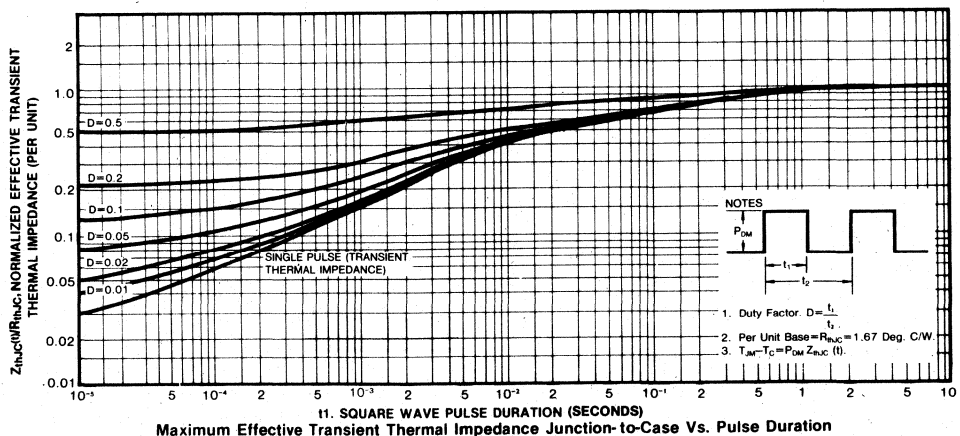
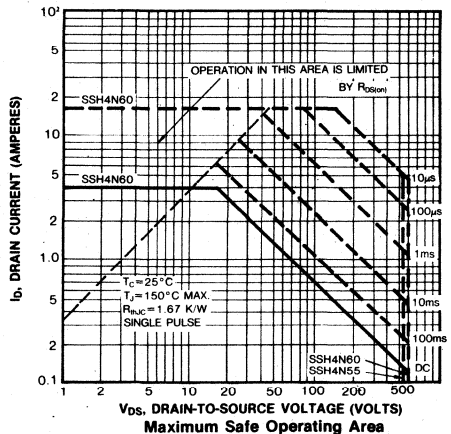
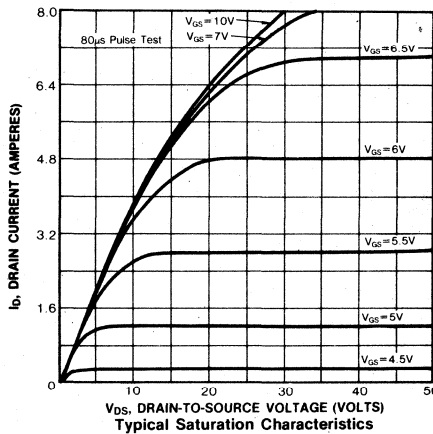
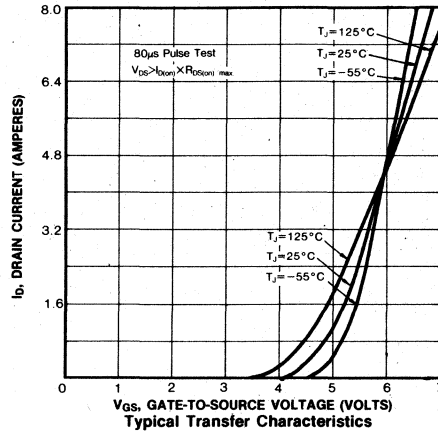
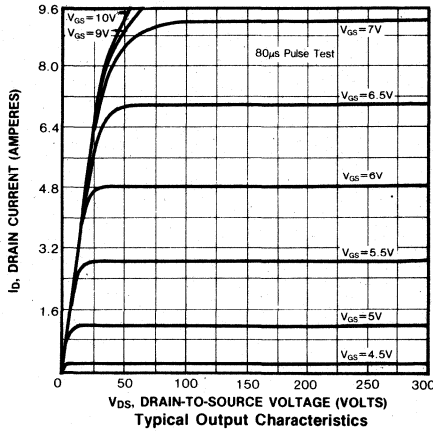

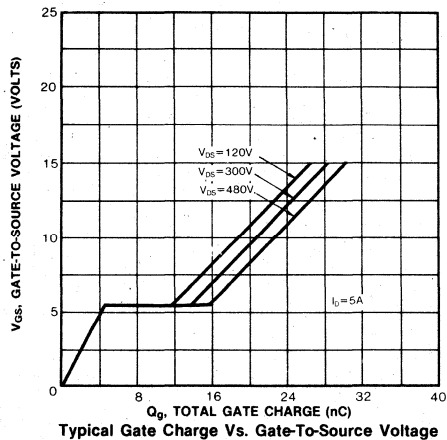
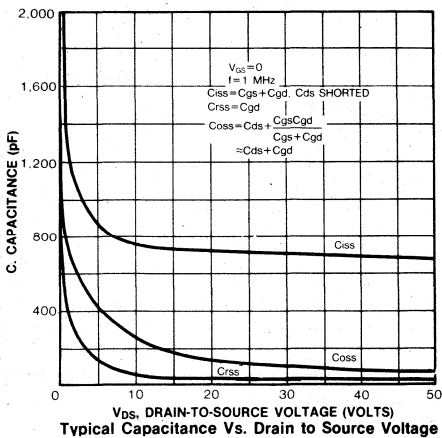
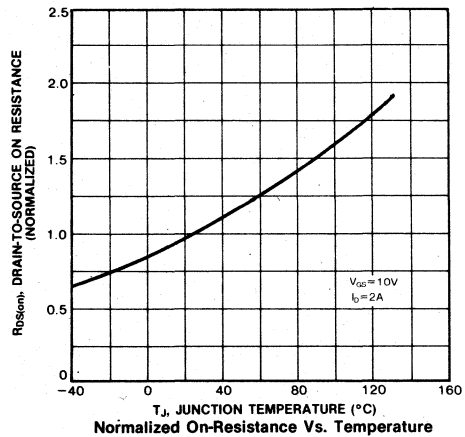
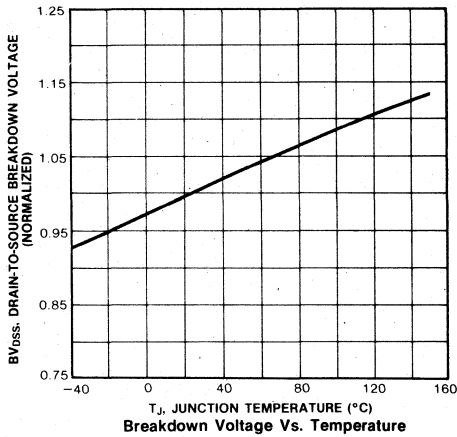
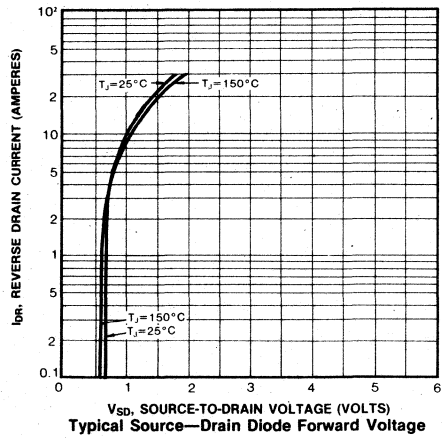
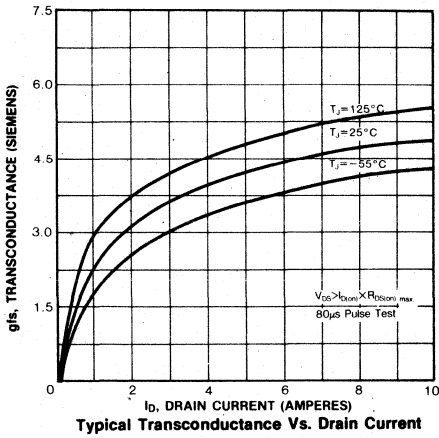

4

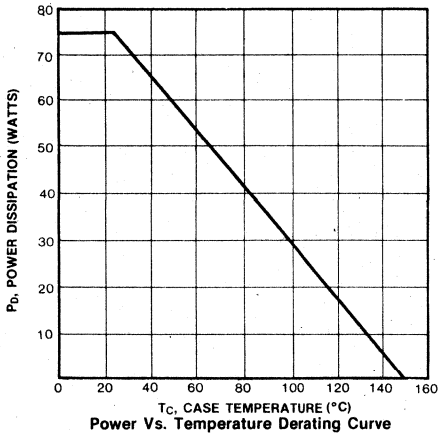
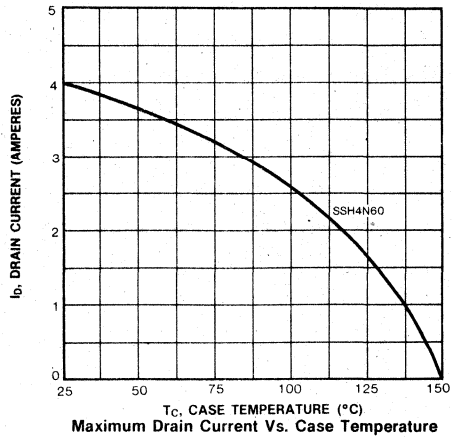
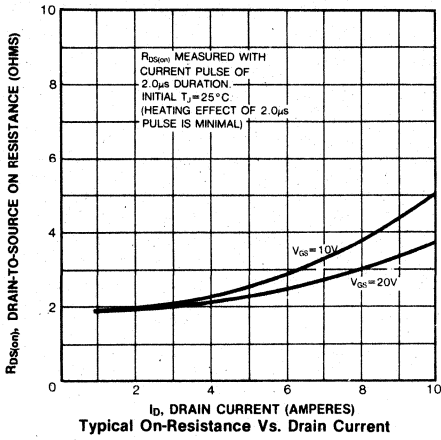

FEATURES

- Low $R_{DS(on)}$ at high voltage
- Improved inductive ruggedness
- Excellent high voltage stability
- Fast switching times
- Rugged polysilicon gate cell structure
- Low input capacitance
- Extended safe operating area
- Improved high temperature reliability
- TO-3P package

PRODUCT SUMMARY

Part Number	V_{DS}	$R_{DS(on)}$	I_D
SSH4N70	700V	2.5 Ω	4A

TO-3P

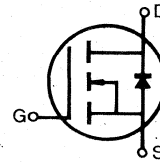
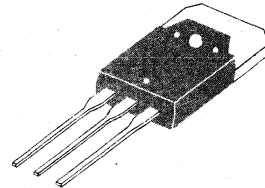

MAXIMUM RATINGS

Characteristic	Symbol	SSH4N70	Unit
Drain-Source Voltage (1)	V_{DS}	700	Vdc
Drain-Gate Voltage ($R_{GS}=1.0M\Omega$) (1)	V_{DGR}	700	Vdc
Gate-Source Voltage	V_{GS}	± 20	Vdc
Continuous Drain Current $T_C=25^\circ C$	I_D	4	Adc
Continuous Drain Current $T_C=100^\circ C$	I_D	2.5	Adc
Drain Current—Pulsed (3)	I_{DM}	16	Adc
Gate Current—Pulsed	I_{GM}	± 1.5	Adc
Total Power Dissipation @ $T_C=25^\circ C$ Derate above $25^\circ C$	P_D	125 1.0	Watts W/ $^\circ C$
Operating and Storage Junction Temperature Range	T_J, T_{stg}	-55 to 150	$^\circ C$
Maximum Lead Temp. for Soldering Purposes, 1/8" from case for 5 seconds	T_L	300	$^\circ C$

- Notes: (1) $T_J=25^\circ C$ to $150^\circ C$
 (2) Pulse test: Pulse width $\leq 300\mu s$, Duty Cycle $\leq 2\%$
 (3) Repetitive rating: Pulse width limited by max. junction temperature

ELECTRICAL CHARACTERISTICS (T_C=25°C unless otherwise specified)

Characteristic	Symbol	Type	Min	Typ	Max	Units	Test Conditions
Drain-Source Breakdown Voltage	BV _{DSS}	ALL	700	—	—	V	V _{GS} =0V I _D =250μA
Gate Threshold Voltage	V _{GS(th)}	ALL	2.0	—	4.5	V	V _{DS} =V _{GS} , I _D =250μA
Gate-Source Leakage Forward	I _{GSS}	ALL	—	—	100	nA	V _{GS} =20V
Gate-Source Leakage Reverse	I _{GSS}	ALL	—	—	-100	nA	V _{GS} =-20V
Zero Gate Voltage Drain Current	I _{DSS}	ALL	—	—	250	μA	V _{DS} =Max. Rating, V _{GS} =0V
			—	—	1000	μA	V _{DS} =Max. Rating×0.8, V _{GS} =0V, T _C =125°C
On-State Drain-Source Current (2)	I _{D(on)}	ALL	4.0	—	—	A	V _{DS} >I _{D(on)} ×R _{DS(on)} max., V _{GS} =10V
Static Drain-Source On-State Resistance (2)	R _{DS(on)}	ALL	—	2.25	2.5	Ω	V _{GS} =10V, I _D =2.0A
Forward Transconductance (2)	g _{fs}	ALL	2.5	3.6	—	S	V _{DS} >I _{D(on)} ×R _{DS(on)} max., I _D =2.0A
Input Capacitance	C _{iss}	ALL	—	1120	1800	pF	V _{GS} =0V, V _{DS} =25V, f=1.0MHz
Output Capacitance	C _{oss}	ALL	—	190	200	pF	
Reverse Transfer Capacitance	C _{rss}	ALL	—	70	75	pF	
Turn-On Delay Time	t _{d(on)}	ALL	—	—	60	ns	V _{DD} =0.5BV _{DSS} , I _D =2.0A, Z _O =4.7 Ω (MOSFET switching times are essentially independent of operating temperature.)
Rise Time	t _r	ALL	—	—	150	ns	
Turn-Off Delay Time	t _{d(off)}	ALL	—	—	300	ns	
Fall Time	t _f	ALL	—	—	130	ns	
Total Gate Charge (Gate-Source Plus Gate-Drain)	Q _g	ALL	—	—	40	nC	V _{GS} =10V, I _D =5.0A, V _{DS} =0.8 Max. Rating (Gate charge is essentially independent of operating temperature.)
Gate-Source Charge	Q _{gs}	ALL	—	—	15	nC	
Gate-Drain ("Miller") Charge	Q _{gd}	ALL	—	—	25	nC	

THERMAL RESISTANCE

Junction-to-Case	R _{thJC}	ALL	—	—	1.0	K/W	
Case-to-Sink	R _{thCS}	ALL	—	0.1	—	K/W	Mounting surface flat, smooth, and greased
Junction-to-Ambient	R _{thJA}	ALL	—	—	80	K/W	Free Air Operation

SOURCE-DRAIN DIODE RATINGS AND CHARACTERISTICS

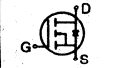
Characteristic	Symbol	Type	Min	Typ	Max	Units	Test Conditions
Continuous Source Current (Body Diode)	I _S	ALL	—	—	4.0	A	Modified MOSFET symbol showing the integral reverse P-N junction rectifier 
Pulse Source Current (Body Diode) (3)	I _{SM}	ALL	—	—	16.0	A	
Diode Forward Voltage (2)	V _{SD}	ALL	—	—	1.5	V	T _C =25°C, I _S =4.0A, V _{GS} =0V
Reverse Recovery Time	t _{rr}	ALL	—	600	—	ns	T _J =150°C, I _F =4.0A, dI _F /dt=100A/μs

Notes: (1) T_J=25°C to 150°C

(2) Pulse test: Pulse width≤300μs, Duty Cycle≤2%

(3) Repetitive rating: Pulse width limited by max. junction temperature

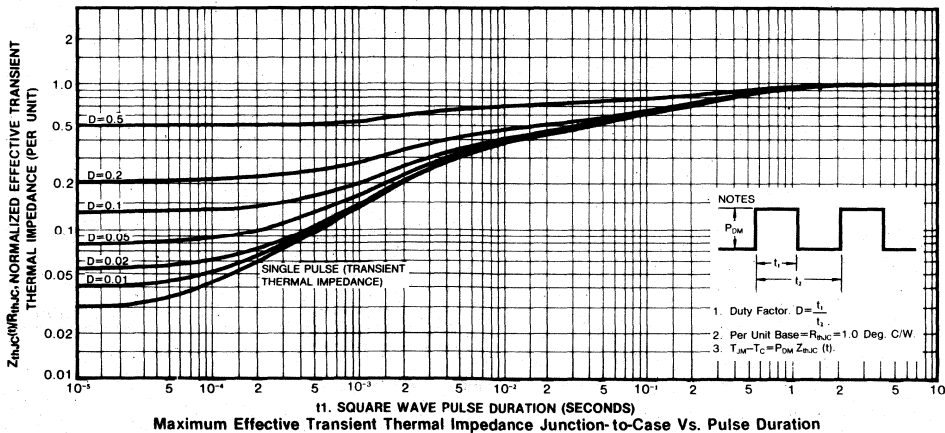
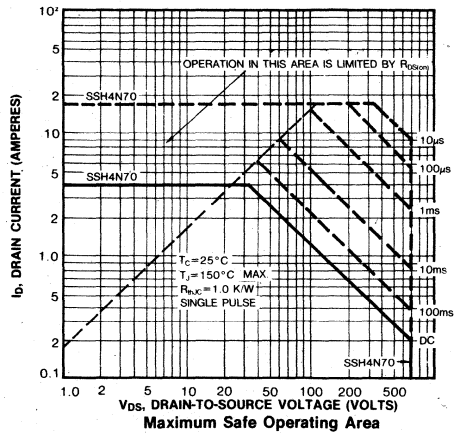
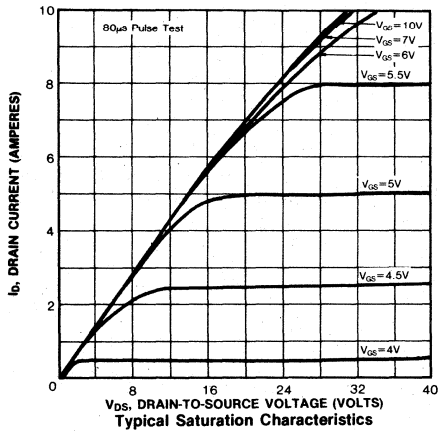
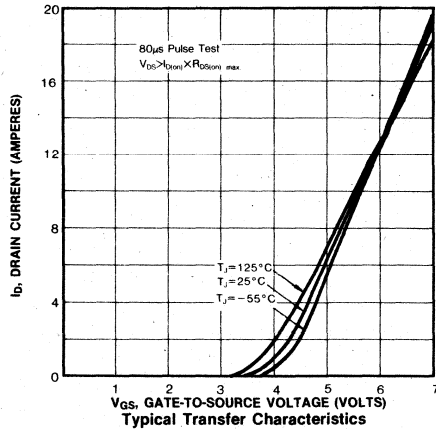
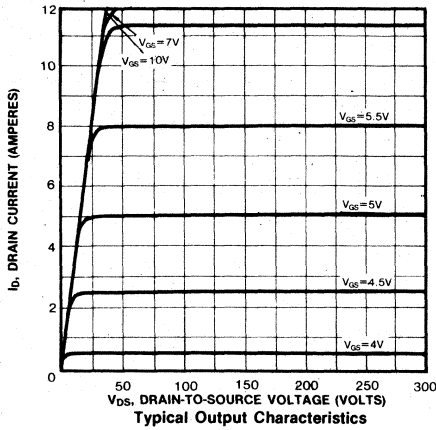

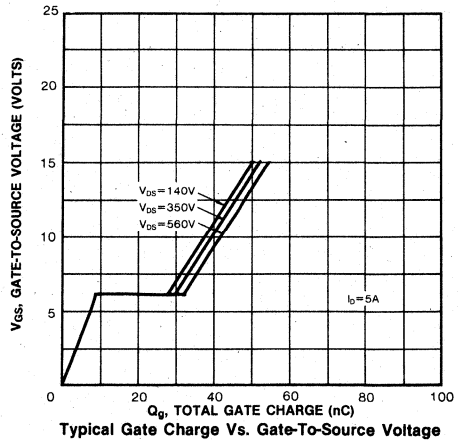
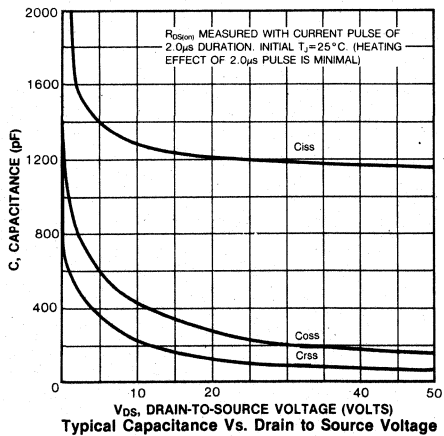
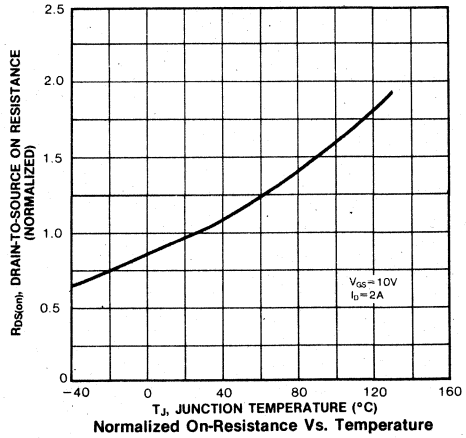
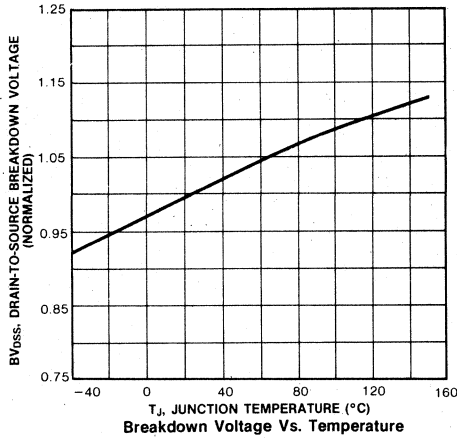
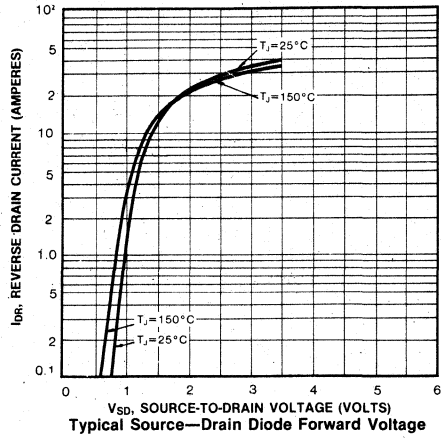
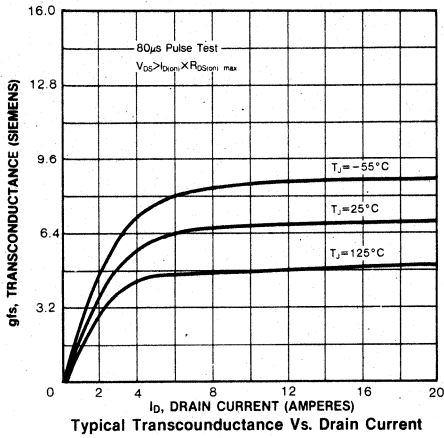

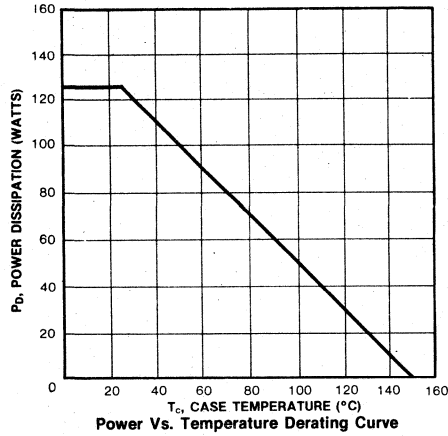
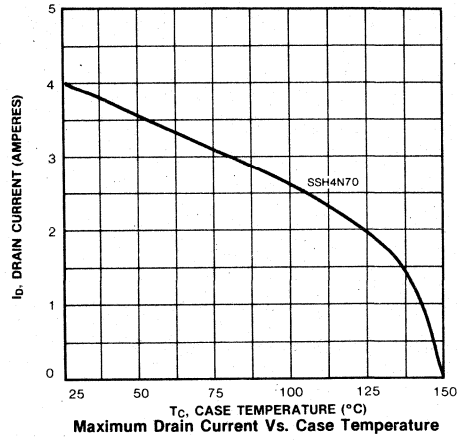
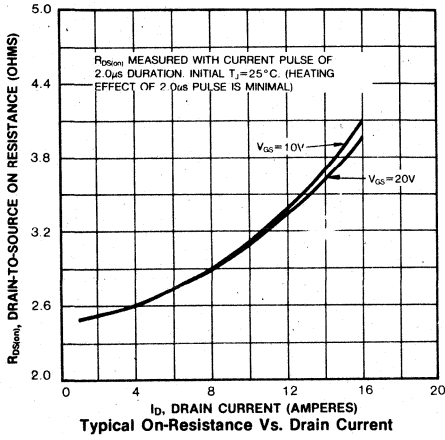

4

FEATURES

- Low $R_{DS(on)}$ at high voltage
- Improved inductive ruggedness
- Excellent high voltage stability
- Fast switching times
- Rugged polysilicon gate cell structure
- Low input capacitance
- Extended safe operating area
- Improved high temperature reliability
- TO-3P package

PRODUCT SUMMARY

Part Number	V_{DS}	$R_{DS(on)}$	I_D
SSM6N55	550V	1.8 Ω	6.0A
SSM6N60	600V	1.8 Ω	6.0A

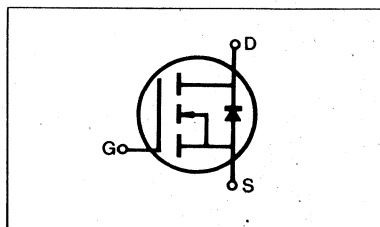
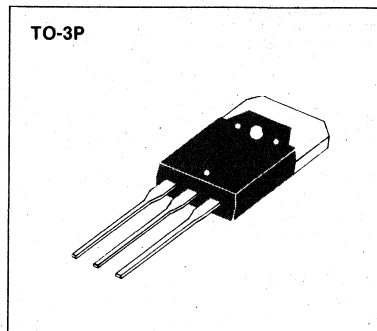

MAXIMUM RATINGS

Characteristic	Symbol	SSH6N55	SSH6N60	Unit
Drain-Source Voltage (1)	V_{DSS}	500	600	Vdc
Drain-Gate Voltage ($R_{GS}=1.0M\Omega$) (1)	V_{DGR}	550	600	Vdc
Gate-Source Voltage	V_{GS}	± 20		Vdc
Continuous Drain Current $T_C=25^\circ C$	I_D	6.0	6.0	Adc
Continuous Drain Current $T_C=100^\circ C$	I_D	4.0	4.0	Adc
Drain Current—Pulsed (3)	I_{DM}	24	24	Adc
Gate Current—Pulsed	I_{GM}	± 1.5		Adc
Total Power Dissipation @ $T_C=25^\circ C$	P_D	125		Watts
Derate above $25^\circ C$		1.0		W/ $^\circ C$
Operating and Storage Junction Temperature Range	T_J, T_{stg}	-55 to 150		$^\circ C$
Maximum Lead Temp. for Soldering Purposes, 1/8" from case for 5 seconds	T_L	300		$^\circ C$

- Notes: (1) $T_J=25^\circ C$ to $150^\circ C$
 (2) Pulse test: Pulse width $\leq 300\mu s$, Duty Cycle $\leq 2\%$
 (3) Repetitive rating: Pulse width limited by max. junction temperature

ELECTRICAL CHARACTERISTICS (T_C=25°C unless otherwise specified)

Characteristic	Symbol	Type	Min	Typ	Max	Units	Test Conditions
Drain-Source Breakdown Voltage	BV _{DSS}	SSH6N55 SSM6N60	550 600	—	—	V	V _{GS} =0V I _D =250μA
Gate Threshold Voltage	V _{GS(th)}	ALL	2.0	—	4.5	V	V _{DS} =V _{GS} , I _D =250μA
Gate-Source Leakage Forward	I _{GSS}	ALL	—	—	100	nA	V _{GS} =0V
Gate-Source Leakage Reverse	I _{GSS}	ALL	—	—	-100	nA	V _{GS} =-20V V _{DS} =0
Zero Gate Voltage Drain Current	I _{DSS}	ALL	—	—	250	μA	V _{DS} =Max. Rating, V _{GS} =0V
			—	—	1000	μA	V _{DS} =Max. Rating×0.8, V _{GS} =0V, T _C =125°C
On-State Drain-Source Current (2)	I _{D(on)}	ALL	6.0	—	—	A	V _{DS} >I _{D(on)} ×R _{DS(on) max.} , V _{GS} =10V
Static Drain-Source On-State Resistance (2)	R _{DS(on)}	ALL	—	1.15	1.8	Ω	V _{GS} =10V I _D =3.0A
Forward Transconductance (2)	g _{fs}	ALL	3.0	4.8	—	Ω	V _{DS} >I _{D(on)} ×R _{DS(on) max.} , I _D =3.0A
Input Capacitance	C _{iss}	ALL	—	1100	1800	pF	
Output Capacitance	C _{oss}	ALL	—	170	350	pF	V _{GS} =0V, V _{DS} =25V, f=1.0MHz
Reverse Transfer Capacitance	C _{rss}	ALL	—	60	150	pF	
Turn-On Delay Time	t _{d(on)}	ALL	—	—	60	ns	
Rise Time	T _r	ALL	—	—	150	ns	V _{DD} =0.5BV _{DSS} , I _D =3.0A, Z _O =4.7Ω
Turn-Off Delay Time	t _{d(off)}	ALL	—	—	200	ns	(MOSFET switching times are essentially independent of operating temperature.)
Fall Time	t _f	ALL	—	—	120	ns	
Total Gate Charge (Gate-Source Plus Gate-Drain)	Q _g	ALL	—	—	40	nC	V _{GS} =10V, I _D =7.5A, V _{DS} =0.8 Max.
Gate-Source Charge	Q _{gs}	ALL	—	—	15	nC	Rating (Gate charge is essentially independent of operating temperature.)
Gate-Drain ("Miller") Charge	Q _{gd}	ALL	—	—	25	nC	

THERMAL RESISTANCE

Junction-to-Case	R _{thJC}	ALL	—	—	1.0	K/W	
Case-to-Sink	R _{thCS}	ALL	—	0.1	—	K/W	Mounting surface flat, smooth, and greased
Junction-to-Ambient	R _{thJA}	ALL	—	—	80	K/W	Free Air Operation

SOURCE-DRAIN DIODE RATINGS AND CHARACTERISTICS

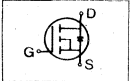
Characteristic	Symbol	Type	Min	Typ	Max	Units	Test Conditions
Continuous Source Current (Body Diode)	I _S	ALL	—	—	6.0	A	Modified MOSFET symbol showing the integral reverse P-N junction rectifier 
Pulse Source Current (Body Diode) 1	I _{SM}	ALL	—	—	24.0	A	
Diode Forward Voltage 2	V _{SD}	ALL	—	1.3	1.5	V	T _C =25°C, I _S =6A, V _{GS} =0V
Reverse Recovery Time	t _{rr}	ALL	—	800	—	ns	T _J =150°C, I _F =6.0A, dI _F /dt=100A/μs

Notes: (1) T_J=25°C to 150°C

(2) Pulse test: Pulse width≤300μs, Duty Cycle≤2%

(3) Repetitive rating: Pulse width limited by max. junction temperature

SSH6N55/6N60

N-CHANNEL POWER MOSFETS

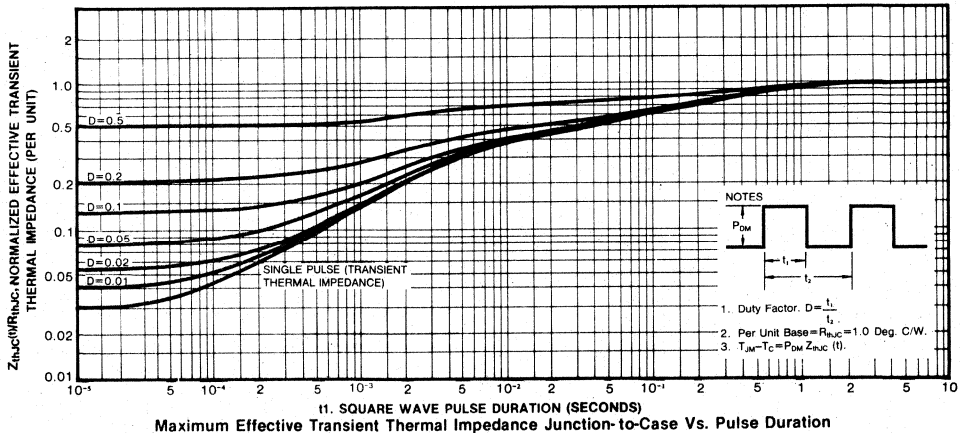
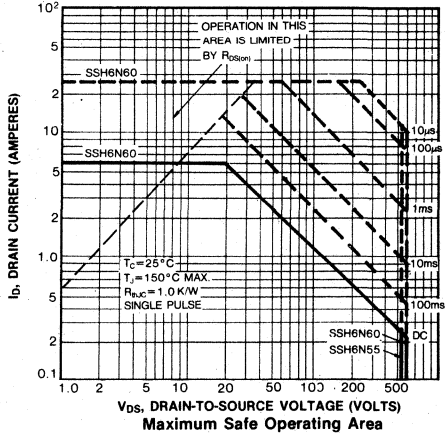
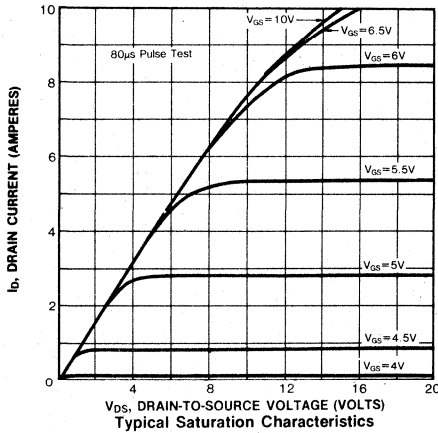
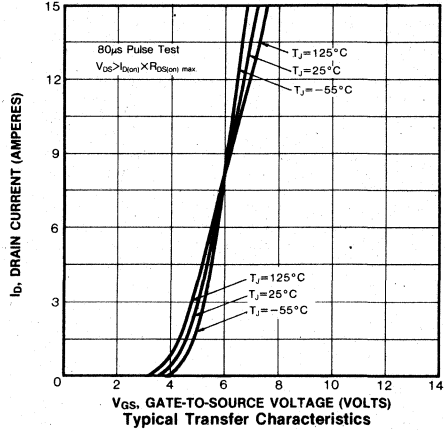
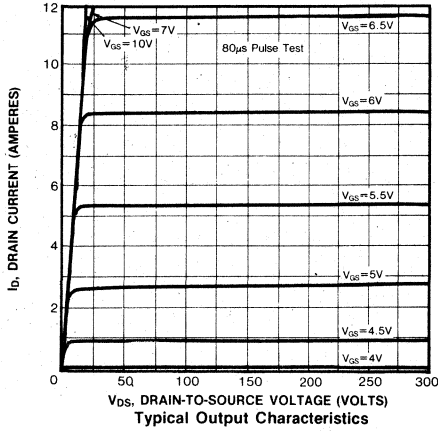

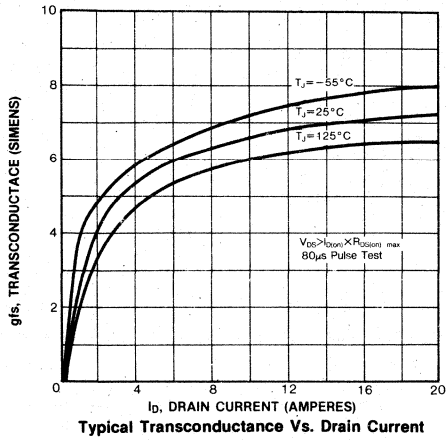

Typical Transconductance Vs. Drain Current

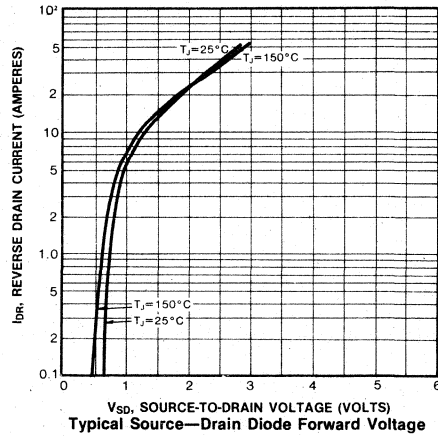

Typical Source-Drain Diode Forward Voltage

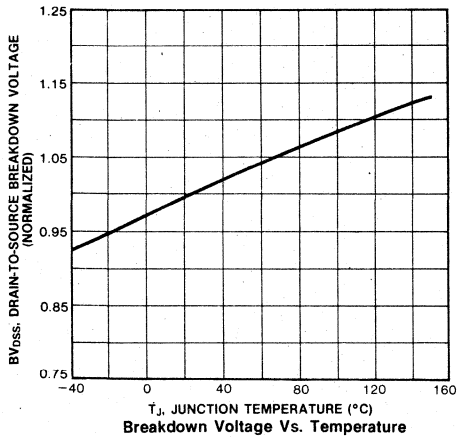

Breakdown Voltage Vs. Temperature

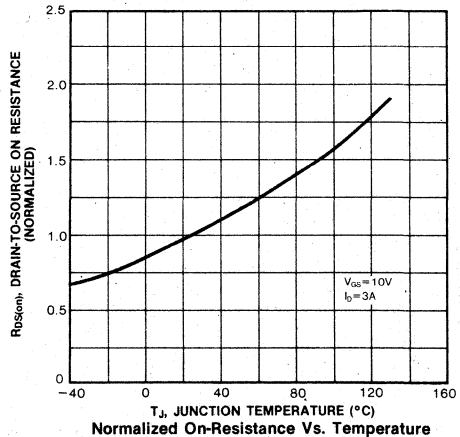

Normalized On-Resistance Vs. Temperature

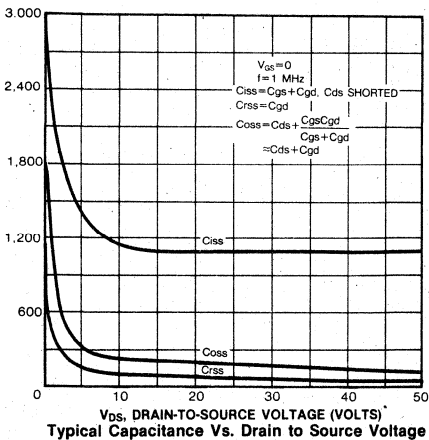

Typical Capacitance Vs. Drain to Source Voltage

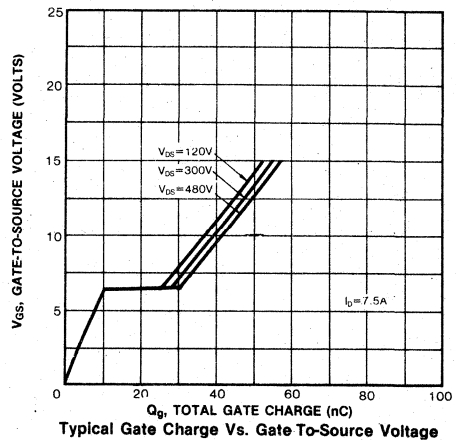

Typical Gate Charge Vs. Gate To-Source Voltage

4

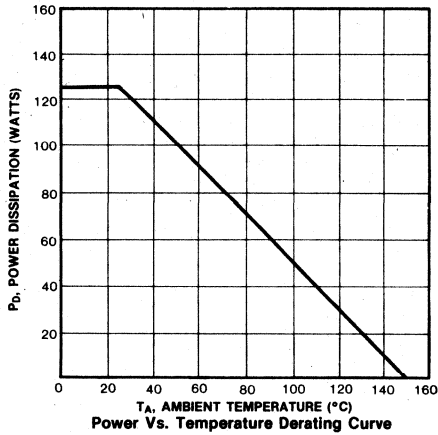
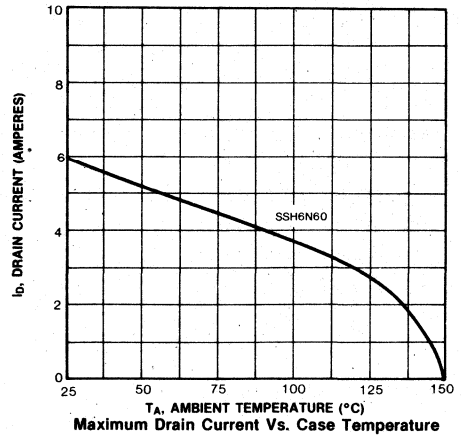
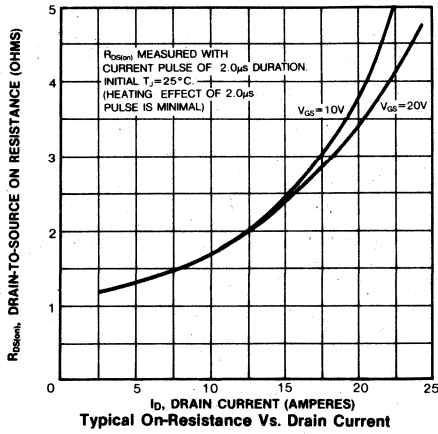

FEATURES

- Low $R_{DS(on)}$ at high voltage
- Improved inductive ruggedness
- Excellent high voltage stability
- Fast switching times
- Rugged polysilicon gate cell structure
- Low input capacitance
- Extended safe operating area
- Improved high temperature reliability
- TO-3P package

PRODUCT SUMMARY

Part Number	V_{DS}	$R_{DS(on)}$	I_D
SSH6N70	700V	1.4 Ω	6A

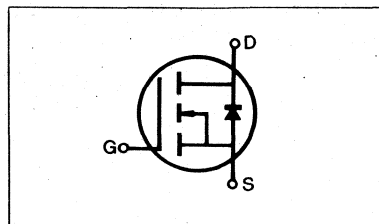
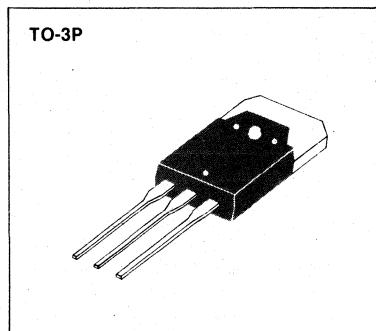

4

MAXIMUM RATINGS

Characteristic	Symbol	SSH6N70	Unit
Drain-Source Voltage (1)	V_{DSS}	700	Vdc
Drain-Gate Voltage ($R_{GS}=1.0M\Omega$)(1)	V_{DGR}	700	Vdc
Gate-Source Voltage	V_{GS}	± 20	Vdc
Continuous Drain Current $T_C=25^\circ C$	I_D	6.0	Adc
Continuous Drain Current $T_C=100^\circ C$	I_D	4.0	Adc
Drain Current—Pulsed (3)	I_{DM}	24	Adc
Gate Current—Pulsed	I_{GM}	± 1.5	Adc
Total Power Dissipation @ $T_C=25^\circ C$ Derate above $25^\circ C$	P_D	150 1.2	Watts W/ $^\circ C$
Operating and Storage Junction Temperature Range	T_J, T_{stg}	-55 to 150	$^\circ C$
Maximum Lead Temp. for Soldering Purposes, 1/8" from case for 5 seconds	T_L	300	$^\circ C$

Notes: (1) $T_J=25^\circ C$ to $150^\circ C$

(2) Pulse test: Pulse width $\leq 300\mu s$, Duty Cycle $\leq 2\%$

(3) Repetitive rating: Pulse width limited by max. junction temperature

ELECTRICAL CHARACTERISTICS (T_C=25°C unless otherwise specified)

Characteristic	Symbol	Type	Min	Typ	Max	Units	Test Conditions
Drain-Source Breakdown Voltage	BV _{DSS}	ALL	700	—	—	V	V _{GS} =0V I _D =250μA
Gate Threshold Voltage	V _{GS(th)}	ALL	2.0	—	4.5	V	V _{DS} =V _{GS} , I _D =250μA
Gate-Source Leakage Forward	I _{GSS}	ALL	—	—	100	nA	V _{GS} =20V
Gate-Source Leakage Reverse	I _{GSS}	ALL	—	—	-100	nA	V _{GS} =-20V
Zero Gate Voltage Drain Current	I _{DSS}	ALL	—	—	250	μA	V _{DS} =Max. Rating, V _{GS} =0V
			—	—	1000	μA	V _{DS} =Max. Rating×0.8, V _{GS} =0V, T _C =125°C
On-State Drain-Source Current (2)	I _{D(on)}	ALL	6.0	—	—	A	V _{DS} >I _{D(on)} ×R _{DS(on)} max., V _{GS} =10V
Static Drain-Source On-State Resistance (2)	R _{DS(on)}	ALL	—	1.0	1.4	Ω	V _{GS} =10V, I _D =3.0A
Forward Transconductance (2)	g _{fs}	ALL	5.0	7.0	—	∅	V _{DS} >I _{D(on)} ×R _{DS(on)} max., I _D =3.0A
Input Capacitance	C _{iss}	ALL	—	2300	2800	pF	V _{GS} =0V, V _{DS} =25V, f=1.0MHz
Output Capacitance	C _{oss}	ALL	—	200	250	pF	
Reverse Transfer Capacitance	C _{rss}	ALL	—	50	100	pF	
Turn-On Delay Time	t _{d(on)}	ALL	—	—	90	ns	V _{DD} =0.5BV _{DSS} , I _D =3.0A, Z _O =4.7Ω, (MOSFET switching times are essentially independent of operating temperature.)
Rise Time	t _r	ALL	—	—	200	ns	
Turn-Off Delay Time	t _{d(off)}	ALL	—	—	450	ns	
Fall Time	t _f	ALL	—	—	150	ns	
Total Gate Charge (Gate-Source Plus Gate-Drain)	Q _g	ALL	—	—	60	nC	V _{GS} =10V, I _D =7.5A, V _{DS} =0.8 Max. Rating (Gate charge is essentially independent of operating temperature.)
Gate-Source Charge	Q _{gs}	ALL	—	—	20	nC	
Gate-Drain ("Miller") Charge	Q _{gd}	ALL	—	—	40	nC	

THERMAL RESISTANCE

Junction-to-Case	R _{thJC}	ALL	—	—	0.83	K/W	
Case-to-Sink	R _{thCS}	ALL	—	0.1	—	K/W	Mounting surface flat, smooth, and greased
Junction-to-Ambient	R _{thJA}	ALL	—	—	80.0	K/W	Free Air Operation

SOURCE-DRAIN DIODE RATINGS AND CHARACTERISTICS

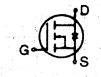
Continuous Source Current (Body Diode)	I _S	ALL	—	—	6.0	A	Modified MOSFET symbol showing the integral reverse P-N junction rectifier	
Pulse Source Current (Body Diode) (3)	I _{SM}	ALL	—	—	24.0	A		
Diode Forward Voltage (2)	V _{SD}	ALL	—	—	1.5	V	T _C =25°C, I _S =6.0A, V _{GS} =0V	
Reverse Recovery Time	t _{rr}	ALL	—	800	—	ns	T _J =150°C, I _F =6.0A, dI _F /dt=100A/μs	

- Notes: (1) T_J=25°C to 150°C
(2) Pulse test: Pulse width≤300μs, Duty Cycle≤2%
(3) Repetitive rating: Pulse width limited by max. junction temperature

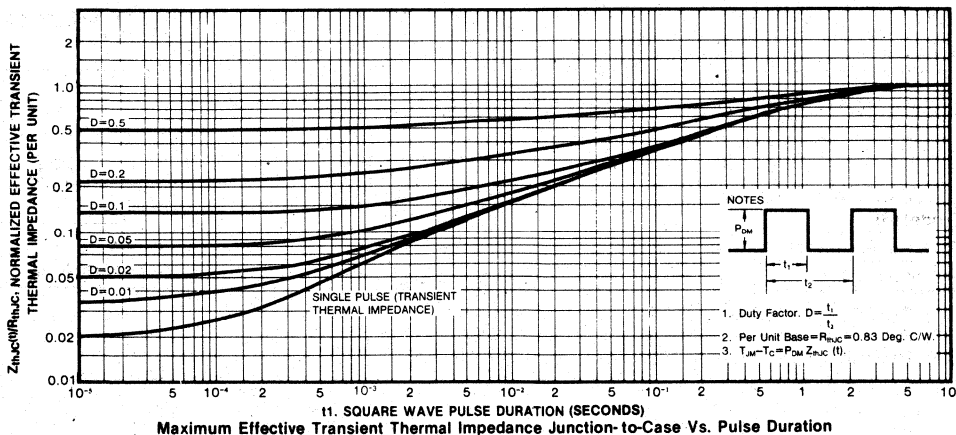
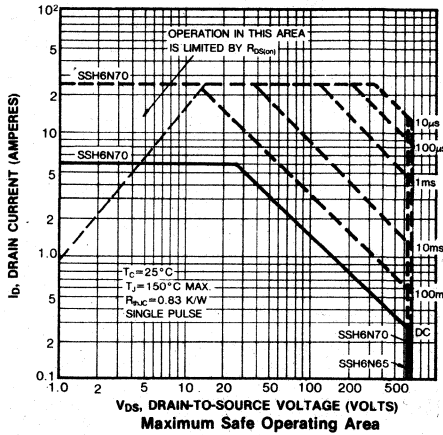
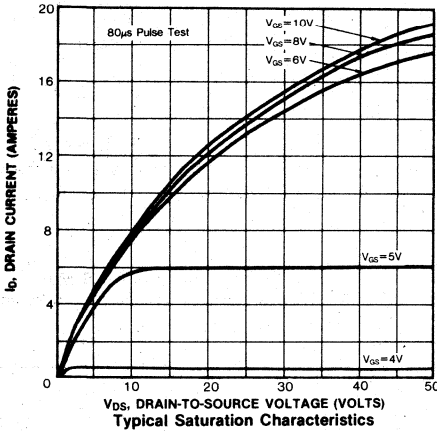
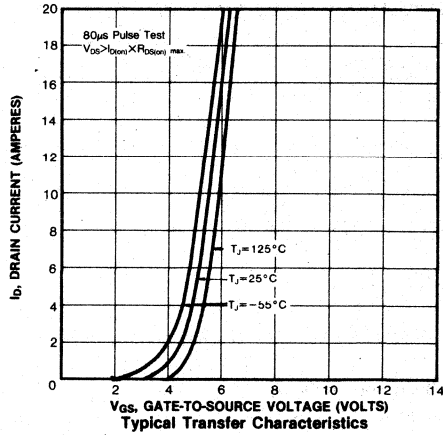
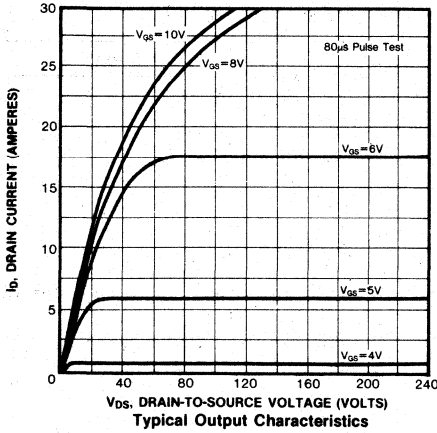

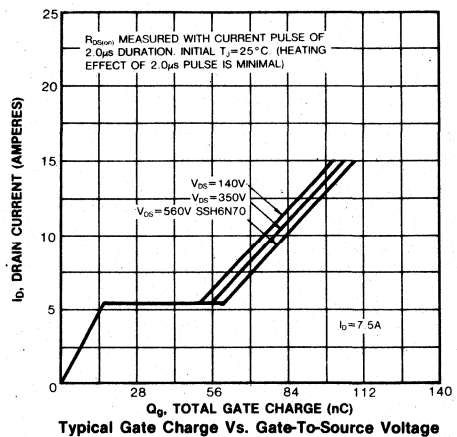
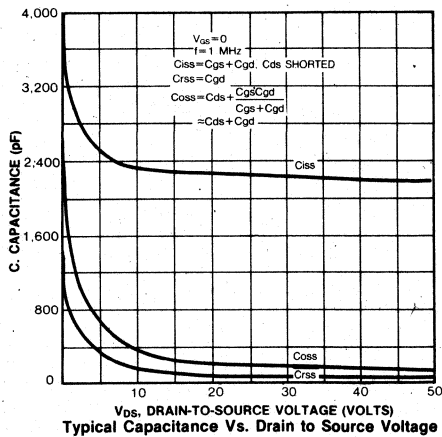
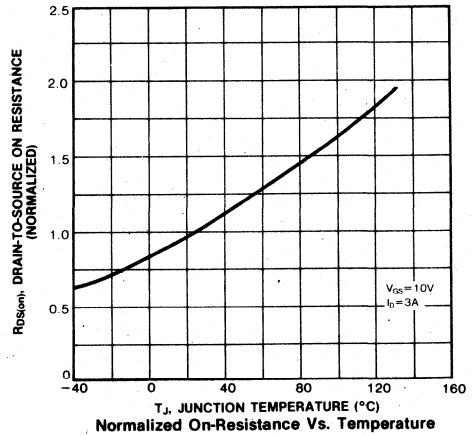
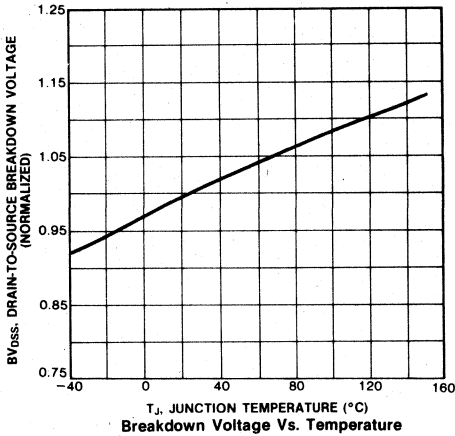
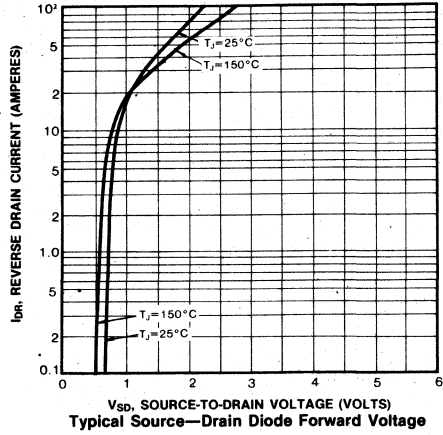
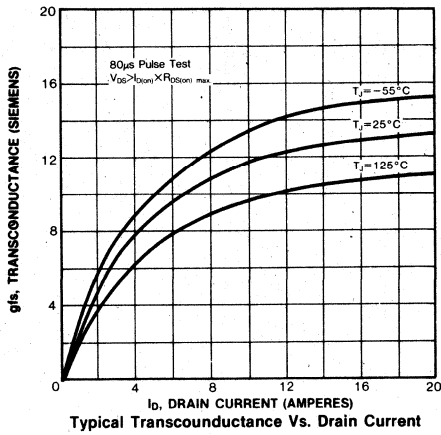

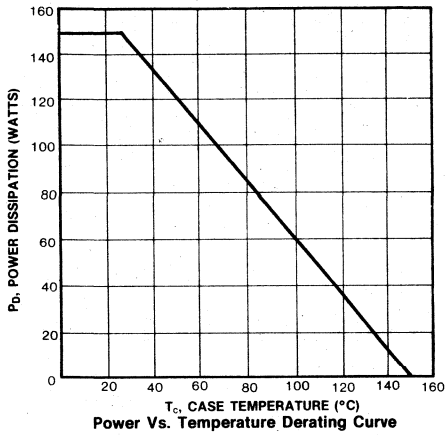
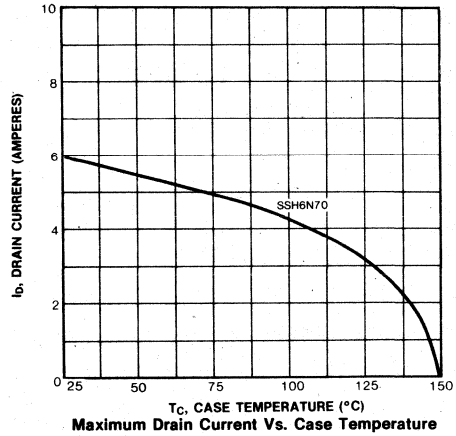
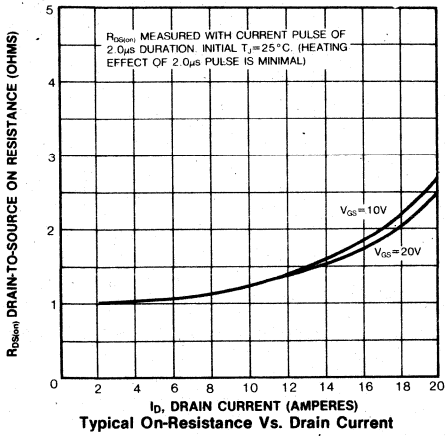

FEATURES

- Low $R_{DS(on)}$ at high voltage
- Improved inductive ruggedness
- Excellent high voltage stability
- Fast switching times
- Rugged polysilicon gate cell structure
- Low input capacitance
- Extended safe operating area
- Improved high temperature reliability
- TO-3P package

PRODUCT SUMMARY

Part Number	V_{DS}	$R_{DS(on)}$	I_D
SSH8N55	550V	1.0 Ω	8A
SSH8N60	600V	2.0 Ω	8A

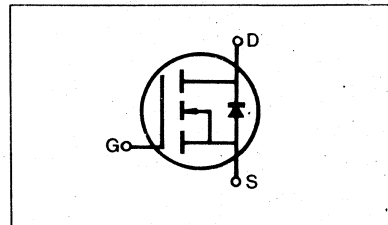
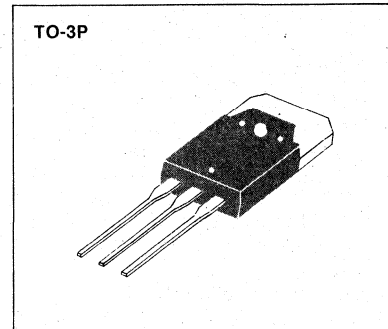

MAXIMUM RATINGS

Characteristic	Symbol	SSH8N55	SSH8N60	Unit
Drain-Source Voltage (1)	V_{DSS}	550	600	Vdc
Drain-Gate Voltage ($R_{GS}=1.0M\Omega$) (1)	V_{DGR}	550	600	Vdc
Gate-Source Voltage	V_{GS}	± 20		Vdc
Continuous Drain Current $T_C=25^\circ C$	I_D	8.0	8.0	Adc
Continuous Drain Current $T_C=100^\circ C$	I_D	5.0	5.0	Adc
Drain Current—Pulsed (3)	I_{DM}	32	32	Adc
Gate Current—Pulsed	I_{GM}	± 1.5		Adc
Total Power Dissipation @ $T_C=25^\circ C$ Derate above $25^\circ C$	P_D	150 1.2		Watts W/ $^\circ C$
Operating and Storage Junction Temperature Range	T_J, T_{stg}	-55 to 150		$^\circ C$
Maximum Lead Temp. for Soldering Purposes, 1/8" from case for 5 seconds	T_L	300		$^\circ C$

- Notes: (1) $T_J=25^\circ C$ to $150^\circ C$
 (2) Pulse test: Pulse width $\leq 300\mu s$, Duty Cycle $\leq 2\%$
 (3) Repetitive rating: Pulse width limited by max. junction temperature

ELECTRICAL CHARACTERISTICS (T_C=25°C unless otherwise specified)

Characteristic	Symbol	Type	Min	Typ	Max	Units	Test Conditions
Drain-Source Breakdown Voltage	BV _{DSS}	SSH8N55 SSH8N60	550 600	—	—	V	V _{GS} =0V I _D =250μA
Gate Threshold Voltage	V _{GS(th)}	ALL	2.0	—	4.5	V	V _{DS} =V _{GS} , I _D =250μA
Gate-Source Leakage Forward	I _{GSS}	ALL	—	—	100	nA	V _{GS} =20V
Gate-Source Leakage Reverse	I _{GSS}	ALL	—	—	-100	nA	V _{GS} =-20V
Zero Gate Voltage Drain Current	I _{DSS}	ALL	—	—	250	μA	V _{DS} =Max. Rating, V _{GS} =0V
			—	—	1000	μA	V _{DS} =Max. Rating×0.8, V _{GS} =0V, T _C =125°C
On-State Drain-Source Current (2)	I _{D(on)}	ALL	8.0	—	—	A	V _{DS} >I _{D(on)} ×R _{DS(on)} max., V _{GS} =10V
Static Drain-Source On-State Resistance (2)	R _{DS(on)}	ALL	—	0.7	1.0	Ω	V _{GS} =10V, I _D =4.0A
Forward Transconductance (2)	g _{fs}	ALL	5.0	5.6	—	∅	V _{DS} >I _{D(on)} ×R _{DS(on)} max., I _D =4.0A
Input Capacitance	C _{iss}	ALL	—	2600	3000	pF	V _{GS} =0V, V _{DS} =25V, f=1.0MHz
Output Capacitance	C _{oss}	ALL	—	400	600	pF	
Reverse Transfer Capacitance	C _{rss}	ALL	—	130	200	pF	
Turn-On Delay Time	t _{d(on)}	ALL	—	—	90	ns	V _{DD} =0.5BV _{DSS} , I _D =4.0A, Z _O =4.7Ω (MOSFET switching times are essentially independent of operating temperature)
Rise Time	t _r	ALL	—	—	200	ns	
Turn-Off Delay Time	t _{d(off)}	ALL	—	—	450	ns	
Fall Time	t _f	ALL	—	—	150	ns	
Total Gate Charge (Gate-Source Plus Gate-Drain)	Q _g	ALL	—	—	120	nC	V _{GS} =10V, I _D =10.0A, V _{DS} =0.8 Max. Rating (Gate charge is essentially independent of operating temperature.)
Gate-Source Charge	Q _{gs}	ALL	—	—	40	nC	
Gate-Drain ("Miller") Charge	Q _{gd}	ALL	—	—	80	nC	

THERMAL RESISTANCE

Junction-to-Case	R _{thJC}	ALL	—	—	0.83	K/W	
Case-to-Sink	R _{thCS}	ALL	—	0.1	—	K/W	Mounting surface flat, smooth, and greased
Junction-to-Ambient	R _{thJA}	ALL	—	—	80.0	K/W	Free Air Operation

SOURCE-DRAIN DIODE RATINGS AND CHARACTERISTICS

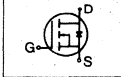
Characteristic	Symbol	Type	Min	Typ	Max	Units	Test Conditions
Continuous Source Current (Body Diode)	I _S	ALL	—	—	8.0	A	Modified MOSFET symbol showing the integral reverse P-N junction rectifier
Pulse Source Current (Body Diode) (3)	I _{SM}	ALL	—	—	32.0	A	
Diode Forward Voltage (2)	V _{SD}	ALL	—	—	1.5	V	T _C =25°C, I _S =8.0A, V _{GS} =0V
Reverse Recovery Time	t _{rr}	ALL	—	800	—	ns	T _J =150°C, I _F =8.0A, dI _F /dt=100A/μs

Notes: (1) T_J=25°C to 150°C (2) Pulse test: Pulse width≤300μs, Duty Cycle≤2%
(3) Repetitive rating: Pulse width limited by max. junction temperature

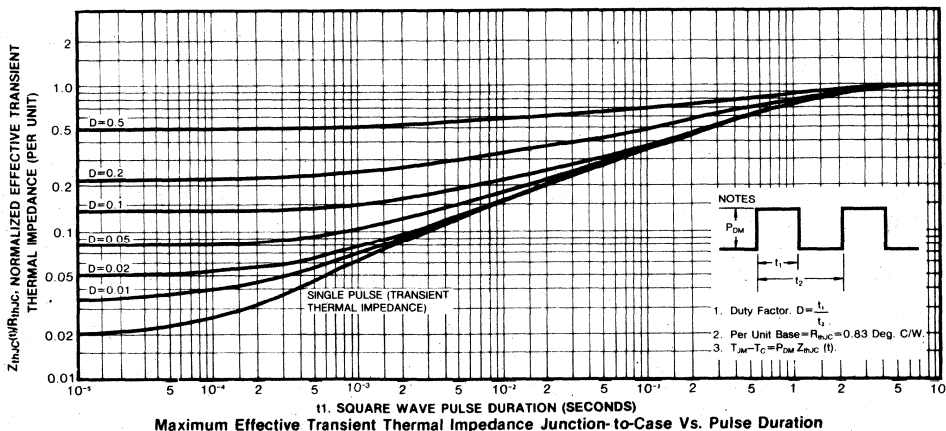
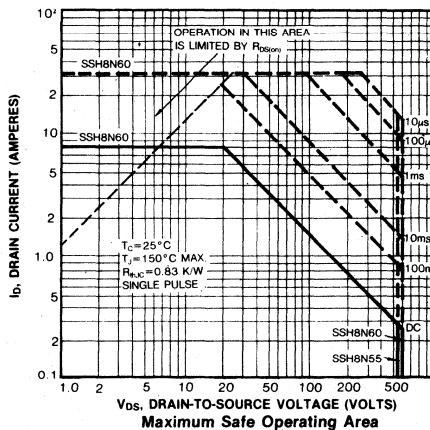
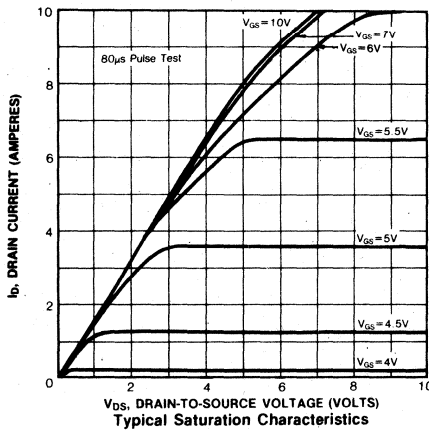
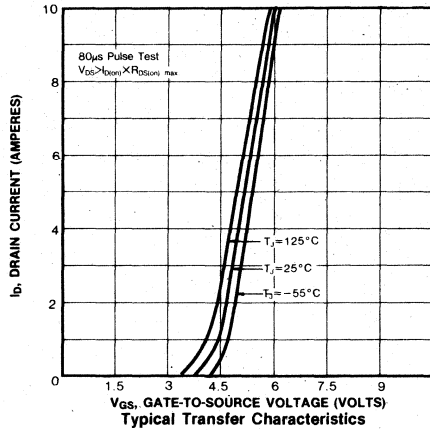
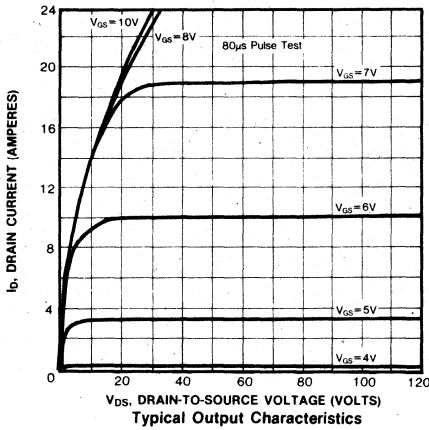

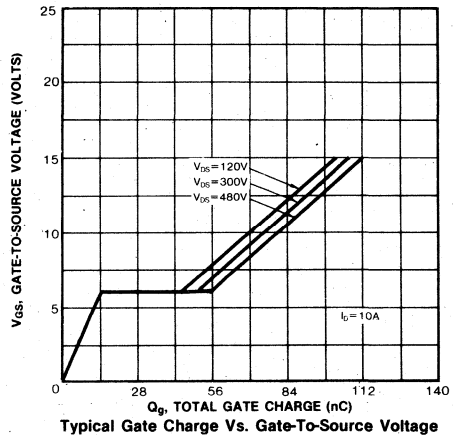
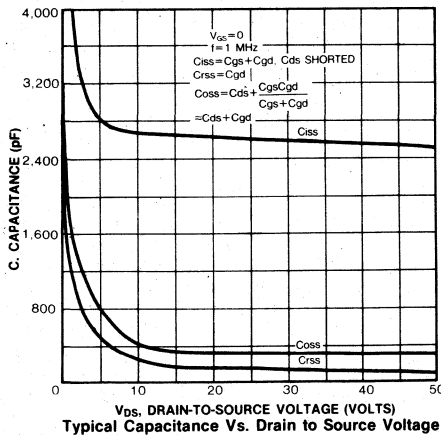
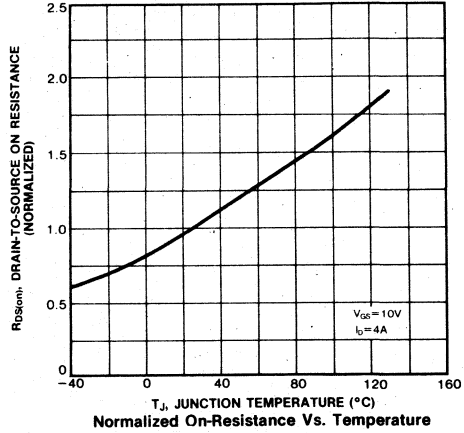
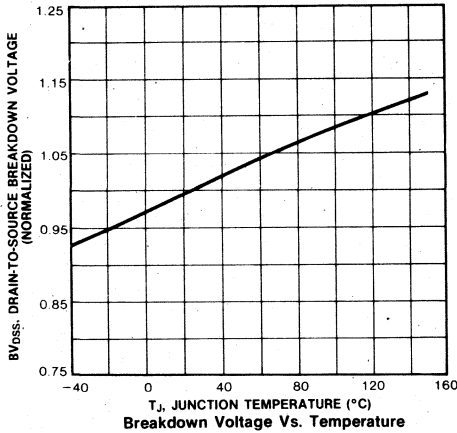
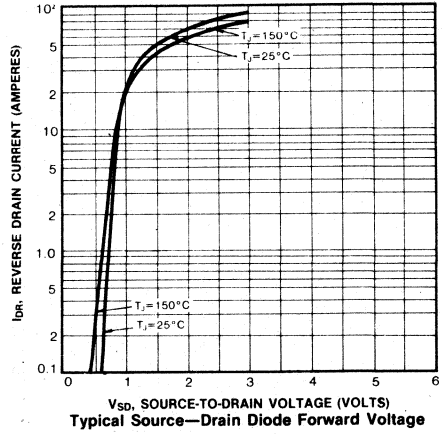
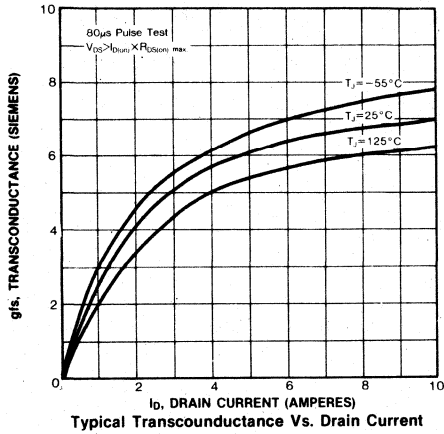

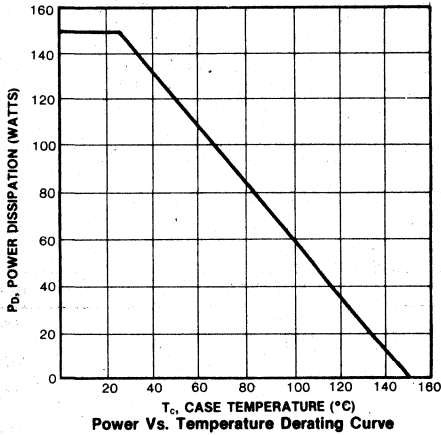
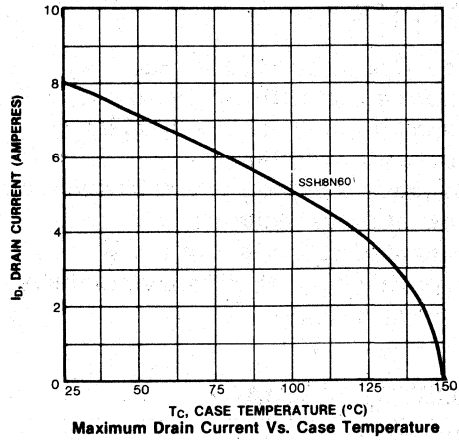
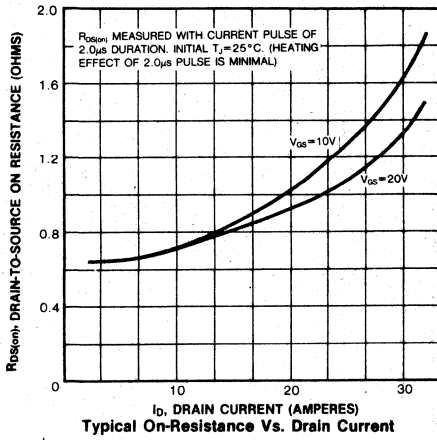

FEATURES

- Low $R_{DS(on)}$ at high voltage
- Improved inductive ruggedness
- Excellent high voltage stability
- Fast switching times
- Rugged polysilicon gate cell structure
- Low input capacitance
- Extended safe operating area
- Improved high temperature reliability
- TO-220 package

PRODUCT SUMMARY

Part Number	V_{DS}	$R_{DS(on)}$	I_D
SSP3N70	700V	5.0 Ω	3A

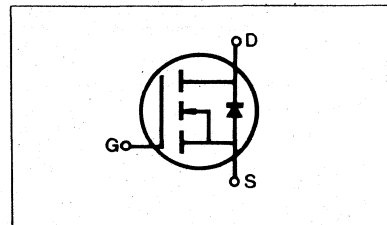
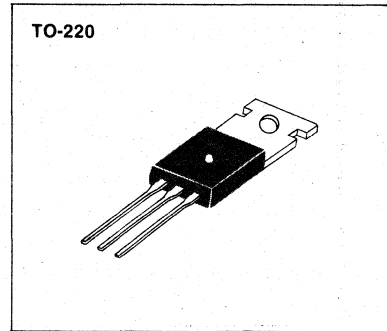

MAXIMUM RATINGS

Characteristic	Symbol	SSP3N70	Unit
Drain-Source Voltage (1)	V_{DS}	700	Vdc
Drain-Gate Voltage ($R_{GS}=1.0M\Omega$) (1)	V_{DGR}	700	Vdc
Gate-Source Voltage	V_{GS}	± 20	Vdc
Continuous Drain Current $T_C=25^\circ C$	I_D	3	Adc
Continuous Drain Current $T_C=100^\circ C$	I_D	2	Adc
Drain Current—Pulsed (3)	I_{DM}	12	Adc
Gate Current—Pulsed	I_{GM}	± 1.5	Adc
Total Power Dissipation @ $T_C=25^\circ C$ Derate above $25^\circ C$	P_D	75 0.6	Watts W/ $^\circ C$
Operating and Storage Junction Temperature Range	T_J, T_{stg}	-55 to 150	$^\circ C$
Maximum Lead Temp. for Soldering Purposes, 1/8" from case for 5 seconds	T_L	300	$^\circ C$

- Notes:**
- (1) $T_J=25^\circ C$ to $150^\circ C$
 - (2) Pulse test: Pulse width $\leq 300\mu s$, Duty Cycle $\leq 2\%$
 - (3) Repetitive rating: Pulse width limited by max. junction temperature

ELECTRICAL CHARACTERISTICS (T_C=25 °C unless otherwise specified)

Characteristic	Symbol	Type	Min	Typ	Max	Units	Test Conditions
Drain-Source Breakdown Voltage	BV _{DSS}	ALL	700	—	—	V	V _{GS} =0V I _D =250μA
Gate Threshold Voltage	V _{GS(th)}	ALL	2.0	—	4.5	V	V _{DS} =V _{GS} , I _D =250μA
Gate-Source Leakage Forward	I _{GSS}	ALL	—	—	100	nA	V _{GS} =20V
Gate-Source Leakage Reverse	I _{GSS}	ALL	—	—	-100	nA	V _{GS} =-20V
Zero Gate Voltage Drain Current	I _{DSS}	ALL	—	—	250	μA	V _{DS} =Max. Rating, V _{GS} =0V
			—	—	1000	μA	V _{DS} =Max. Rating×0.8, V _{GS} =0V, T _C =125 °C
On-State Drain-Source Current (2)	I _{D(on)}	ALL	3.0	—	—	A	V _{DS} >I _{D(on)} ×R _{DS(on) max.} , V _{GS} =10V
Static Drain-Source On-State Resistance (2)	R _{DS(on)}	ALL	—	4.8	5.0	Ω	V _{GS} =10V, I _D =1.5A
Forward Transconductance (2)	g _{fs}	ALL	1.5	2.5	—	∅	V _{DS} >I _{D(on)} ×R _{DS(on) max.} , I _D =1.5A
Input Capacitance	C _{iss}	ALL	—	730	900	pF	
Output Capacitance	C _{oss}	ALL	—	70	75	pF	V _{GS} =0V, V _{DS} =25V, f=1.0MHz
Reverse Transfer Capacitance	C _{rss}	ALL	—	20	25	pF	
Turn-On Delay Time	t _{d(on)}	ALL	—	—	40	ns	
Rise Time	t _r	ALL	—	—	95	ns	
Turn-Off Delay Time	t _{d(off)}	ALL	—	—	150	ns	
Fall Time	t _f	ALL	—	—	60	ns	
Total Gate Charge (Gate-Source Plus Gate-Drain)	Q _g	ALL	—	—	25	nC	
Gate-Source Charge	Q _{gs}	ALL	—	—	10	nC	
Gate-Drain ("Miller") Charge	Q _{gd}	ALL	—	—	15	nC	

THERMAL RESISTANCE

Junction-to-Case	R _{thJC}	ALL	—	—	1.67	K/W	
Case-to-Sink	R _{thCS}	ALL	—	1.0	—	K/W	Mounting surface flat, smooth, and greased
Junction-to-Ambient	R _{thJA}	ALL	—	—	80	K/W	Free Air Operation

SOURCE-DRAIN DIODE RATINGS AND CHARACTERISTICS

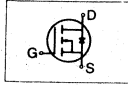
Continuous Source Current (Body Diode)	I _S	ALL	—	—	3.0	A	Modified MOSFET symbol showing the integral reverse P-N junction rectifier 
Pulse Source Current (Body Diode) (3)	I _{SM}	ALL	—	—	12.0	A	
Diode Forward Voltage (2)	V _{SD}	ALL	—	—	1.5	V	T _C =25 °C, I _S =3.0A, V _{GS} =0V
Reverse Recovery Time	t _{rr}	ALL	—	500	—	ns	T _J =150 °C, I _F =3.0A, dI _F /dt=100A/μs

Notes: (1) T_J=25 °C to 150 °C

(2) Pulse test: Pulse width≤300μs, Duty Cycle≤2%

(3) Repetitive rating: Pulse width limited by max. junction temperature

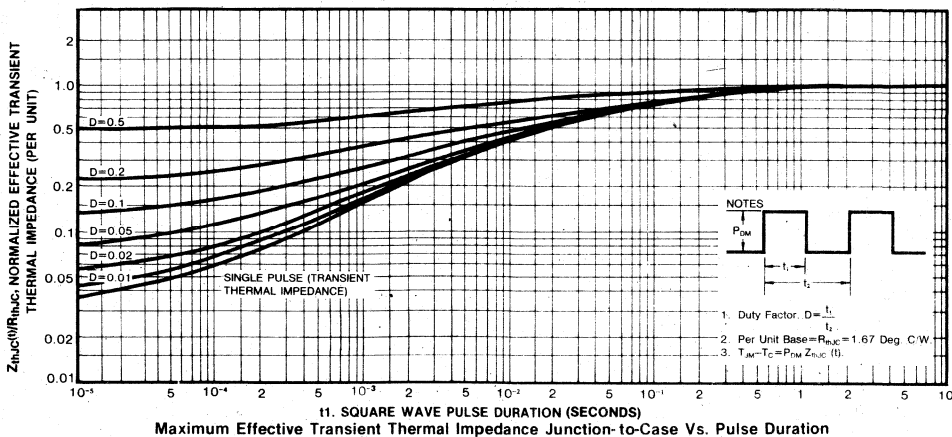
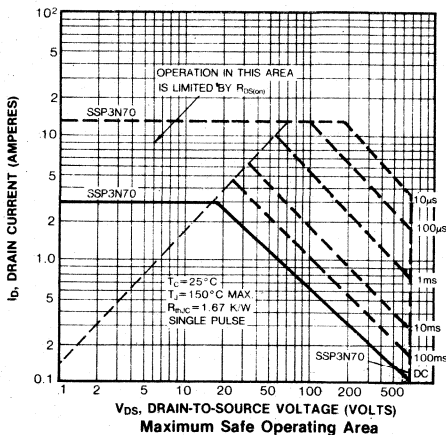
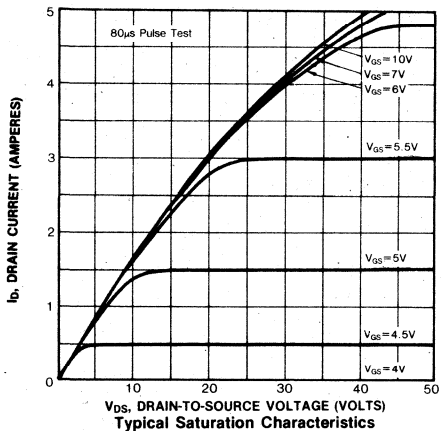
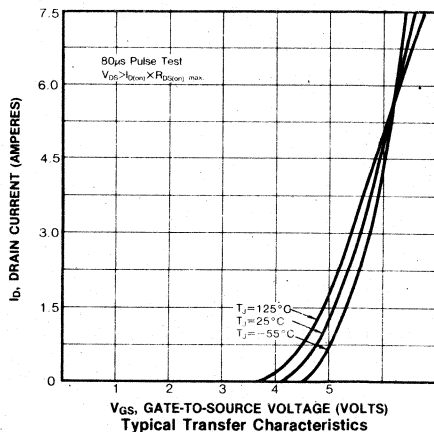
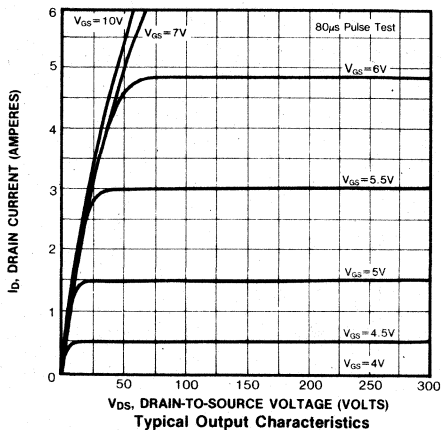

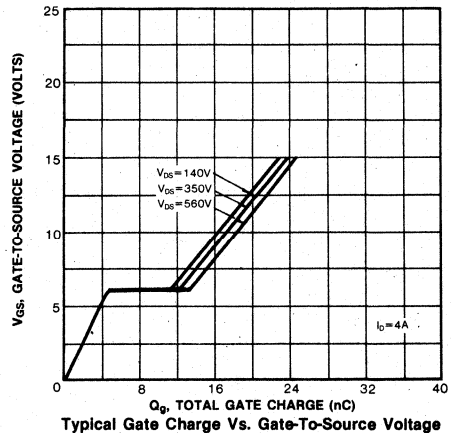
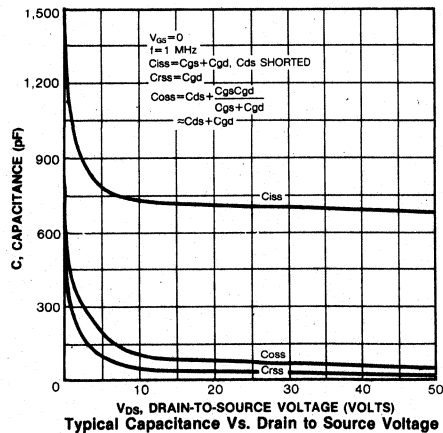
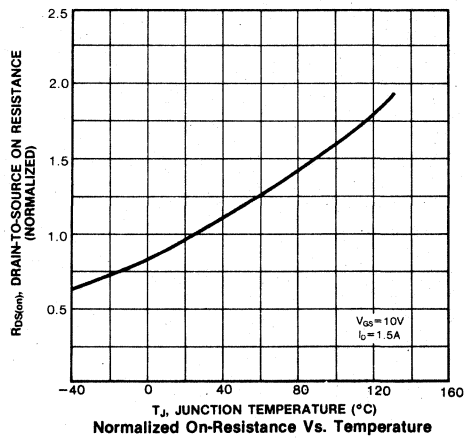
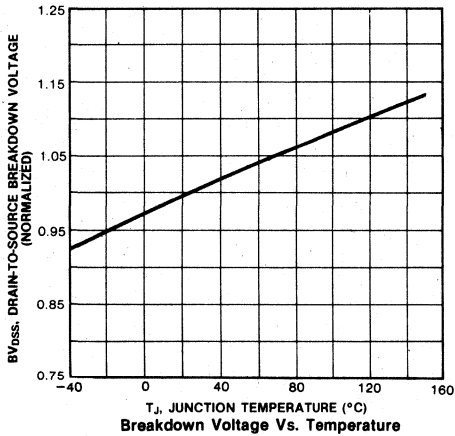
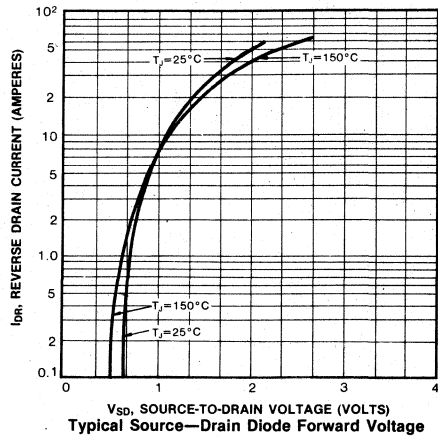
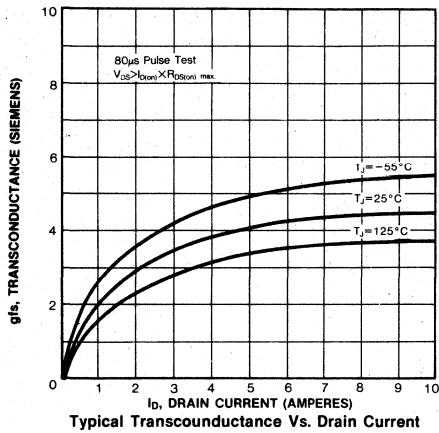

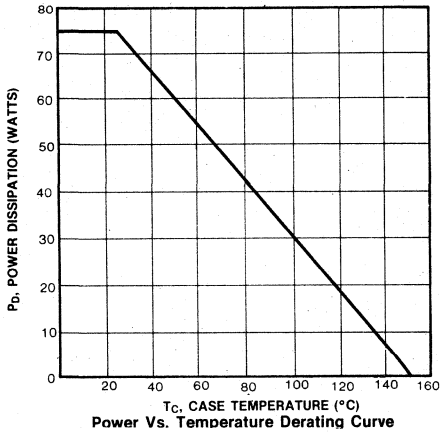
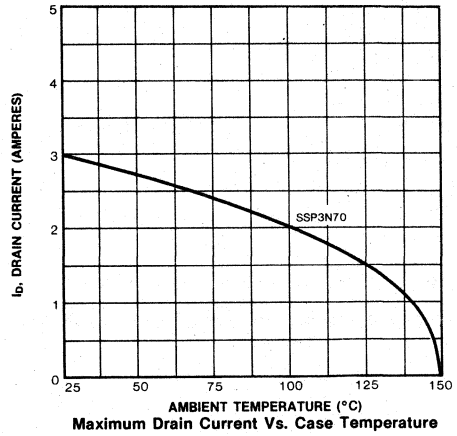
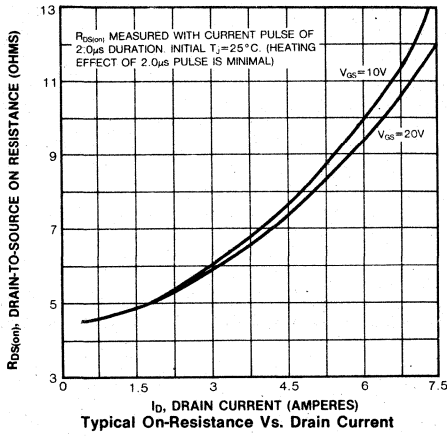

4

FEATURES

- Lower $R_{DS(on)}$
- Improved inductive ruggedness
- Excellent high voltage stability
- Fast switching times
- Rugged polysilicon gate cell structure
- Lower input capacitance
- Extended safe operating area
- Improved high temperature reliability
- TO-220 package

PRODUCT SUMMARY

Part Number	V_{DS}	$R_{DS(on)}$	I_D
SSP4N55	550V	$3.0\ \Omega$	4A
SSP4N60	600V	$3.0\ \Omega$	4A

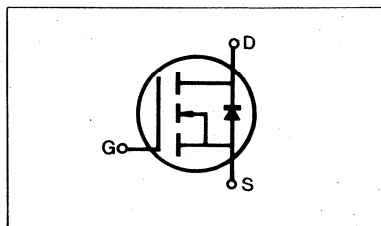
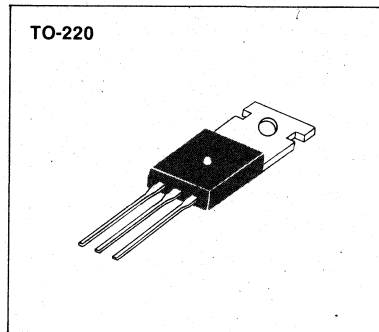

MAXIMUM RATINGS

Characteristic	Symbol	SSP4N55	SSP4N60	Unit
Drain-Source Voltage (1)	V_{DSS}	550	600	Vdc
Drain-Gate Voltage ($R_{GS}=1.0M\Omega$) (1)	V_{DGR}	550	600	Vdc
Gate-Source Voltage	V_{GS}	± 20		Vdc
Continuous Drain Current $T_C=25^\circ C$	I_D	4	4	Adc
Continuous Drain Current $T_C=100^\circ C$	I_D	2.5	2.5	Adc
Drain Current—Pulsed (3)	I_{DM}	16	16	Adc
Gate Current—Pulsed	I_{GM}	± 1.5		Adc
Total Power Dissipation @ $T_C=25^\circ C$ Derate above $25^\circ C$	P_D	75 0.6		Watts W/ $^\circ C$
Operating and Storage Junction Temperature Range	T_J, T_{Stg}	-55 to 150		$^\circ C$
Maximum Lead Temp. for Soldering Purposes, 1/8" from case for 5 seconds	T_L	300		$^\circ C$

- Notes:** (1) $T_J=25^\circ C$ to $150^\circ C$
 (2) Pulse test: Pulse width $\leq 300\mu s$, Duty Cycle $\leq 2\%$
 (3) Repetitive rating: Pulse width limited by max. junction temperature

ELECTRICAL CHARACTERISTICS (T_C=25°C unless otherwise specified)

Characteristic	Symbol	Type	Min	Typ	Max	Units	Test Conditions
Drain-Source Breakdown Voltage	BV _{DSS}	SSP4N55 SSP4N60	550 600	—	—	V	V _{GS} =0V I _D =250μA
Gate Threshold Voltage	V _{GS(th)}	ALL	2.0	—	4.5	V	V _{DS} =V _{GS} , I _D =250μA
Gate-Source Leakage Forward	I _{GSS}	ALL	—	—	100	nA	V _{GS} =20V
Gate-Source Leakage Reverse	I _{GSS}	ALL	—	—	-100	nA	V _{GS} =-20V
Zero Gate Voltage Drain Current	I _{DSS}	ALL	—	—	250	μA	V _{DS} =Max. Rating, V _{GS} =0V
			—	—	1000	μA	V _{DS} =Max. Rating×0.8, V _{GS} =0V, T _C =125°C
On-State Drain-Source Current (2)	I _{D(on)}	ALL	4.0	—	—	A	V _{DS} >I _{D(on)} ×R _{DS(on) max.} , V _{GS} =10V
Static Drain-Source On-State Resistance (2)	R _{DS(on)}	ALL	—	2.0	3.0	Ω	V _{GS} =0V, I _D =2.0A
Forward Transconductance (2)	g _{fs}	ALL	2.0	3.1	—	S	V _{DS} >I _{D(on)} ×R _{DS(on) max.} , I _D =2.0A
Input Capacitance	C _{iss}	ALL	—	720	900	pF	V _{GS} =0V, V _{DS} =25V, f=1.0MHz
Output Capacitance	C _{oss}	ALL	—	110	200	pF	
Reverse Transfer Capacitance	C _{rss}	ALL	—	40	60	pF	
Turn-On Delay Time	t _{d(on)}	ALL	—	—	40	ns	V _{DD} =0.5BV _{DSS} , I _D =2.0A, Z _O =15Ω (MOSFET switching times are essentially independent of operating temperature.)
Rise Time	t _r	ALL	—	—	95	ns	
Turn-Off Delay Time	t _{d(off)}	ALL	—	—	150	ns	
Fall Time	t _f	ALL	—	—	60	ns	
Total Gate Charge (Gate-Source Plus Gate-Drain)	Q _g	ALL	—	—	25	nC	V _{GS} =+10V, I _D =+5.0A, V _{DS} =0.8 Max. Rating (Gate charge is essentially independent of operating temperature.)
Gate-Source Charge	Q _{gs}	ALL	—	—	10	nC	
Gate-Drain ("Miller") Charge	Q _{gd}	ALL	—	—	15	nC	

4

THERMAL RESISTANCE

Junction-to-Case	R _{thJC}	ALL	—	—	1.67	K/W	
Case-to-Sink	R _{thCS}	ALL	—	1.0	—	K/W	Mounting surface flat, smooth, and greased
Junction-to-Ambient	R _{thJA}	ALL	—	—	80		Free Air Operation

SOURCE-DRAIN DIODE RATINGS AND CHARACTERISTICS

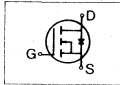
Characteristic	Symbol	Type	Min	Typ	Max	Units	Test Conditions
Continuous Source Current (Body Diode)	I _S	ALL	—	—	4.0	A	Modified MOSFET symbol showing the integral reverse P-N junction rectifier 
Pulse Source Current (Body Diode) (3)	I _{SM}	ALL	—	—	16.0	A	
Diode Forward Voltage (2)	V _{SD}	ALL	—	—	1.5	V	T _C =25°C, I _S =4.0A, V _{GS} =0V
Reverse Recovery Time	t _{rr}	ALL	—	600	—	ns	T _J =150°C, I _F =8.0A, dI _F /dt=100A/μs

Notes: (1) T_J=25°C to 150°C

(2) Pulse test; Pulse width≤300μs, Duty Cycle≤2%

(3) Repetitive rating; Pulse width limited by max. junction temperature

SSP4N55/4N60

N-CHANNEL POWER MOSFETS

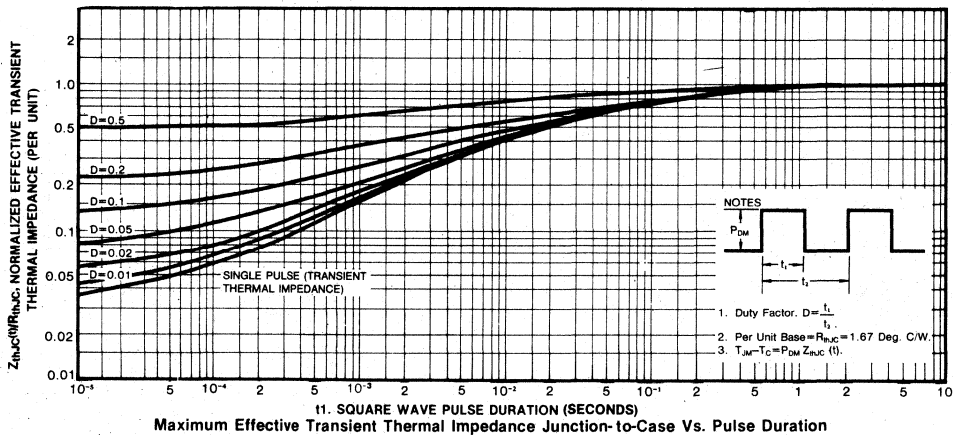
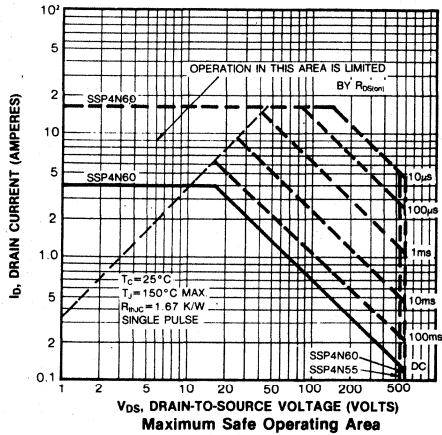
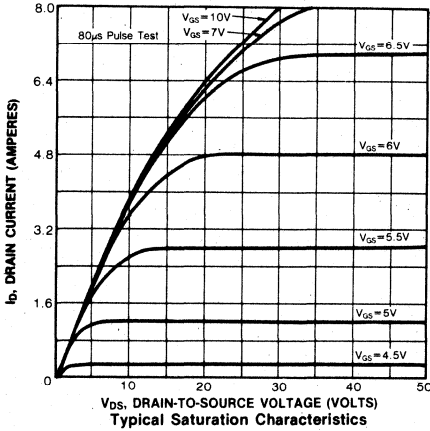
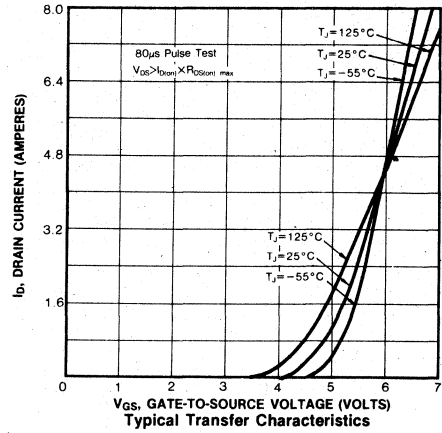
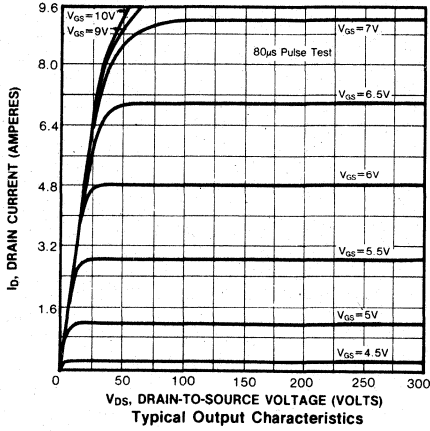

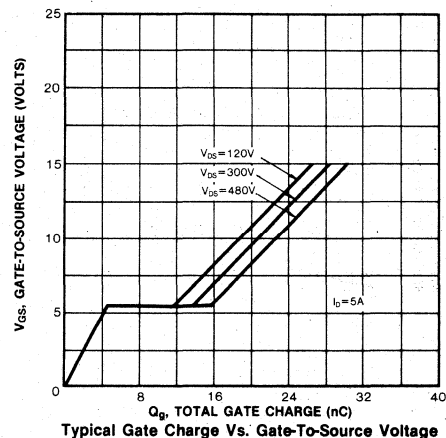
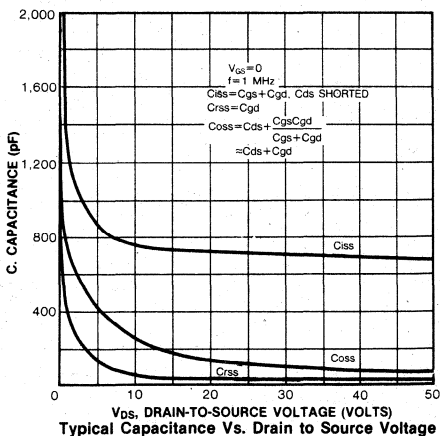
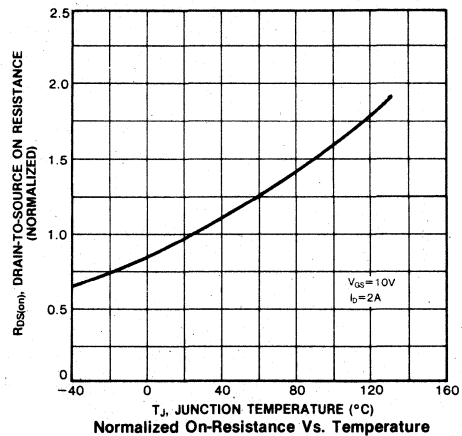
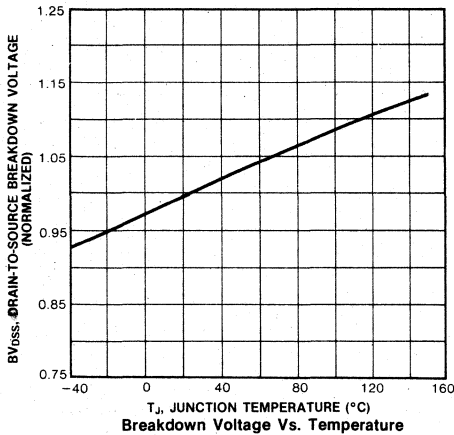
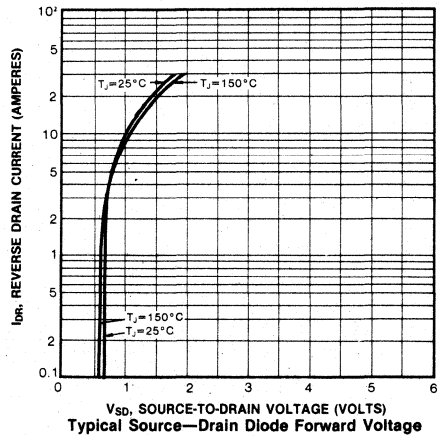
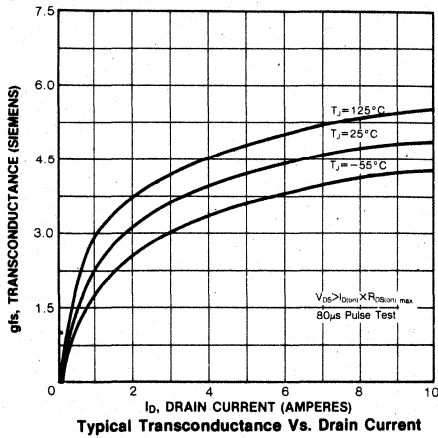

4

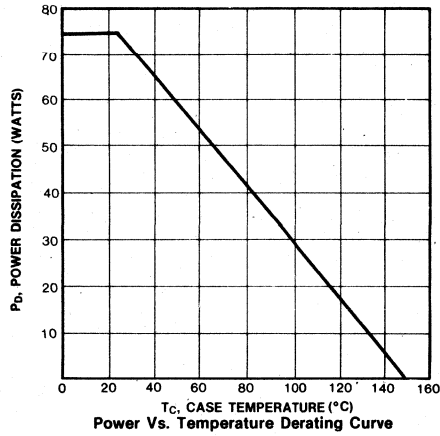
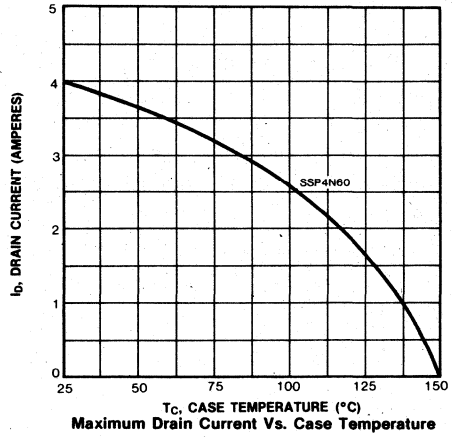
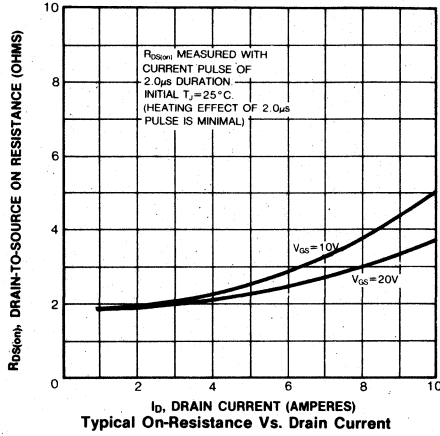

FEATURES

- Low $R_{DS(on)}$ at high voltage
- Improved inductive ruggedness
- Excellent high voltage stability
- Fast switching times
- Rugged polysilicon gate cell structure
- Low input capacitance
- Extended safe operating area
- Improved high temperature reliability
- TO-220 package

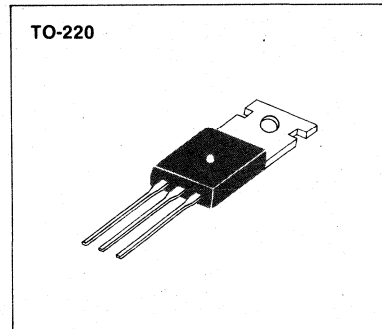

PRODUCT SUMMARY

Part Number	V_{DS}	$R_{DS(on)}$	I_D
SSP4N70	700V	2.5 Ω	4.0A

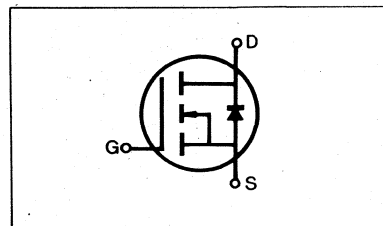

4

MAXIMUM RATINGS

Characteristic	Symbol	SSP4N70	Unit
Drain-Source Voltage (1)	V_{DS}	700	Vdc
Drain-Gate Voltage ($R_{GS}=1.0M\Omega$) (1)	V_{DGR}	700	Vdc
Gate-Source Voltage	V_{GS}	± 20	Vdc
Continuous Drain Current $T_C=25^\circ C$	I_D	4.0	Adc
Continuous Drain Current $T_C=100^\circ C$	I_D	2.5	Adc
Drain Current—Pulsed (3)	I_{DM}	16	Adc
Gate Current—Pulsed	I_{GM}	± 1.5	Adc
Total Power Dissipation @ $T_C=25^\circ C$. Derate above $25^\circ C$	P_D	125 1.0	Watts W/ $^\circ C$
Operating and Storage Junction Temperature Range	T_J, T_{stg}	-55 to 150	$^\circ C$
Maximum Lead Temp. for Soldering Purposes, 1/8" from case for 5 seconds	T_L	300	$^\circ C$

Notes: (1) $T_J=25^\circ C$ to $150^\circ C$

(2) Pulse test: Pulse width $\leq 300\mu s$, Duty Cycle $\leq 2\%$

(3) Repetitive rating: Pulse width limited by max. junction temperature

ELECTRICAL CHARACTERISTICS (T_C=25°C unless otherwise specified)

Characteristic	Symbol	Type	Min	Typ	Max	Units	Test Conditions
Drain-Source Breakdown Voltage	BV _{DSS}	ALL	700	—	—	V	V _{GS} =0V I _D =250μA
Gate Threshold Voltage	V _{GS(th)}	ALL	2.0	—	4.5	V	V _{DS} =V _{GS} , I _D =250μA
Gate-Source Leakage Forward	I _{GSS}	ALL	—	—	100	nA	V _{GS} =20V
Gate-Source Leakage Reverse	I _{GSS}	ALL	—	—	-100	nA	V _{GS} =-20V
Zero Gate Voltage Drain Current	I _{DSS}	ALL	—	—	250	μA	V _{DS} =Max. Rating, V _{GS} =0V
			—	—	1000	μA	V _{DS} =Max. Rating×0.8, V _{GS} =0V, T _C =125°C
On-State Drain-Source Current (2)	I _{D(on)}	ALL	4.0	—	—	A	V _{DS} >I _{D(on)} ×R _{DS(on) max.} , V _{GS} =10V
Static Drain-Source On-State Resistance (2)	R _{DS(on)}	ALL	—	2.25	2.5	Ω	V _{GS} =10V, I _D =2.0A
Forward Transconductance (2)	g _{fs}	ALL	2.5	3.6	—	Ω	V _{DS} >I _{D(on)} ×R _{DS(on) max.} , I _D =2.0A
Input Capacitance	C _{iss}	ALL	—	1120	1800	pF	V _{GS} =0V, V _{DS} =25V, f=1.0MHz
Output Capacitance	C _{oss}	ALL	—	190	200	pF	
Reverse Transfer Capacitance	C _{rss}	ALL	—	70	75	pF	
Turn-On Delay Time	t _{d(on)}	ALL	—	—	60	ns	V _{DD} =0.5BV _{DSS} , I _D =2.0A, Z _O =4.7Ω. (MOSFET switching times are essentially independent of operating temperature.)
Rise Time	t _r	ALL	—	—	150	ns	
Turn-Off Delay Time	t _{d(off)}	ALL	—	—	300	ns	
Fall Time	t _f	ALL	—	—	130	ns	
Total Gate Charge (Gate-Source Plus Gate-Drain)	Q _g	ALL	—	—	40	nC	V _{GS} =10V, I _D =5.0A, V _{DS} =0.8 Max. Rating (Gate charge is essentially independent of operating temperature.)
Gate-Source Charge	Q _{gs}	ALL	—	—	15	nC	
Gate-Drain ("Miller") Charge	Q _{gd}	ALL	—	—	25	nC	

THERMAL RESISTANCE

Junction-to-Case	R _{thJC}	ALL	—	—	1.0	K/W	
Case-to-Sink	R _{thCS}	ALL	—	1.0	—	K/W	Mounting surface flat, smooth, and greased
Junction-to-Ambient	R _{thJA}	ALL	—	—	80	K/W	Free Air Operation

SOURCE-DRAIN DIODE RATINGS AND CHARACTERISTICS

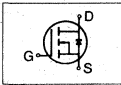
Characteristic	Symbol	Type	Min	Typ	Max	Units	Test Conditions
Continuous Source Current (Body Diode)	I _S	ALL	—	—	4.0	A	Modified MOSFET symbol showing the integral reverse P-N junction rectifier 
Pulse Source Current (Body Diode) (3)	I _{SM}	ALL	—	—	16.0	A	
Diode Forward Voltage (2)	V _{SD}	ALL	—	—	1.5	V	T _C =25°C, I _S =4.0A, V _{GS} =0V
Reverse Recovery Time	t _{rr}	ALL	—	600	—	ns	T _J =150°C, I _F =4.0A, dI _F /dt=100A/μs

- Notes:** (1) T_J=25°C to 150°C
 (2) Pulse test: Pulse width≤300μs, Duty Cycle≤2%
 (3) Repetitive rating: Pulse width limited by max. junction temperature

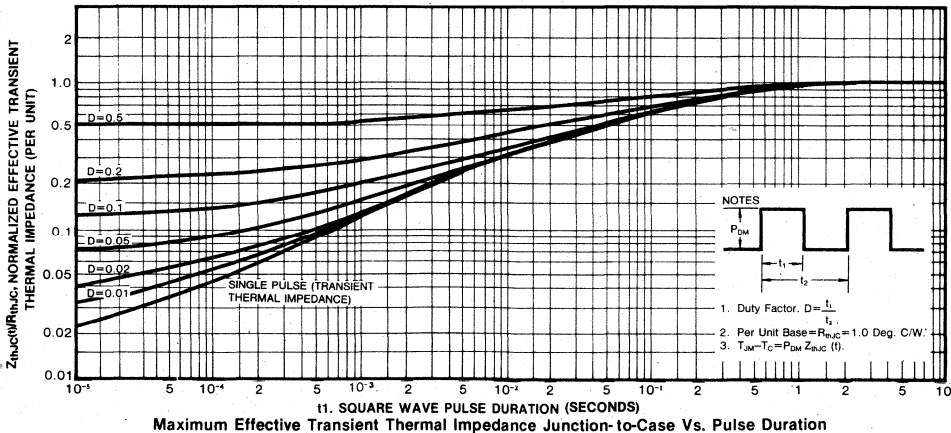
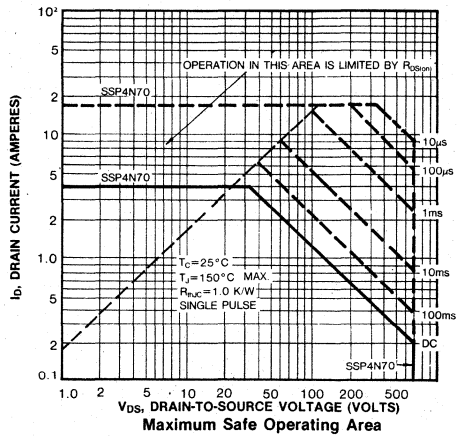
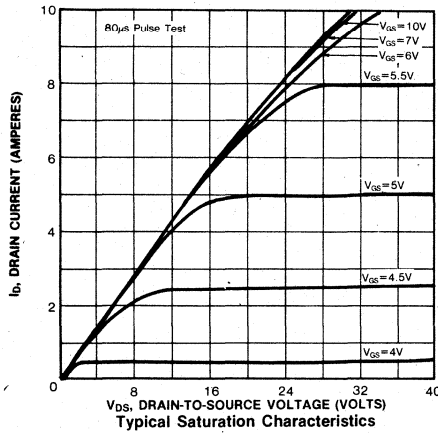
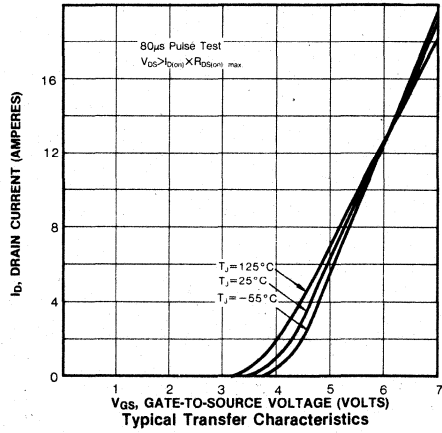
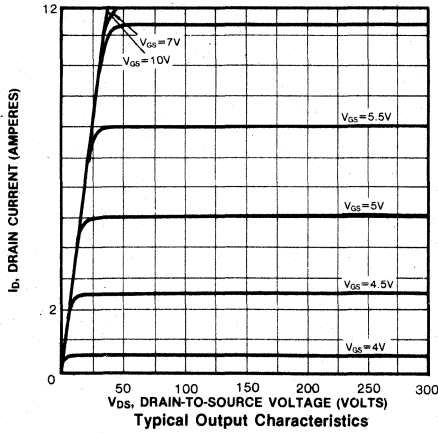

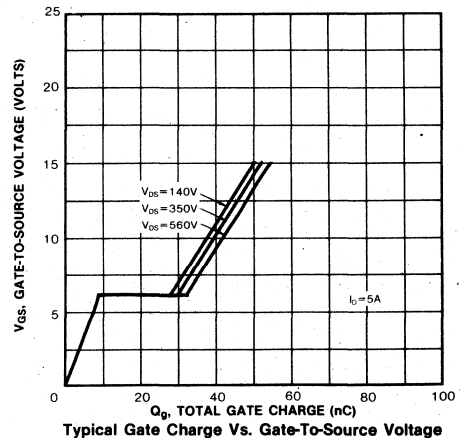
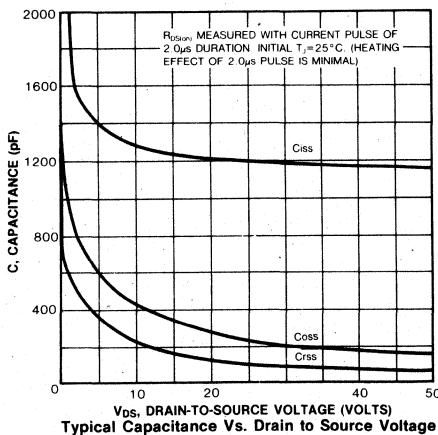
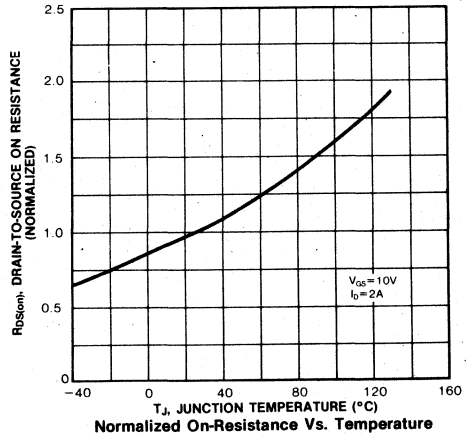
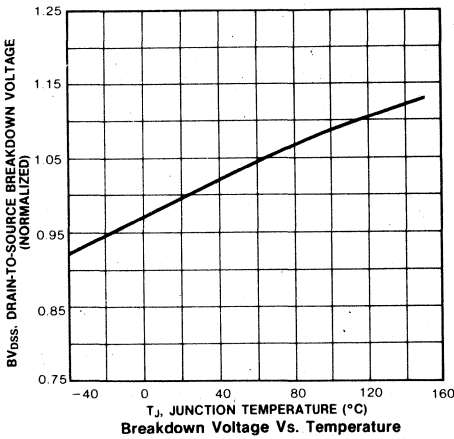
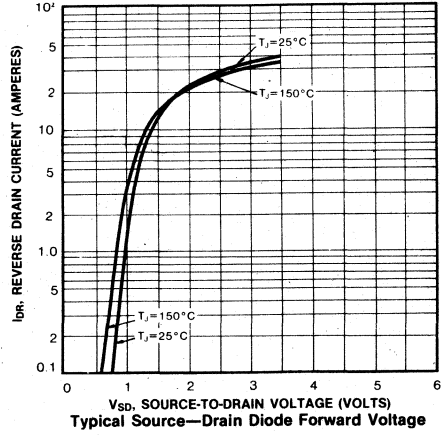
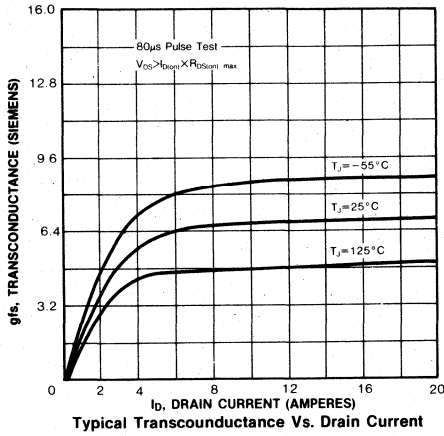

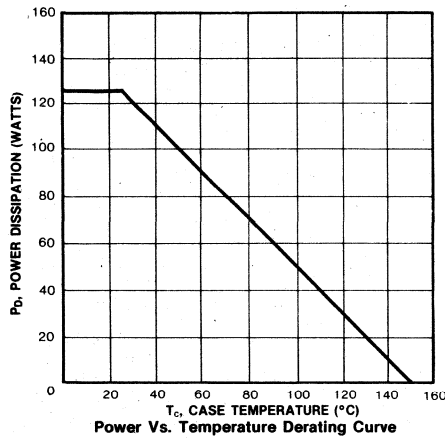
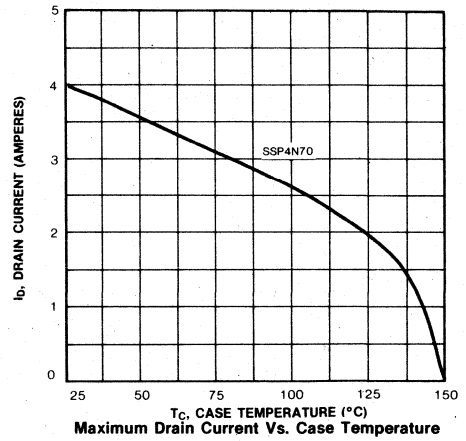
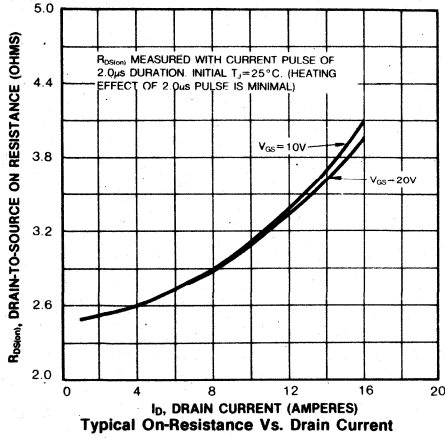

4

FEATURES

- Low $R_{DS(on)}$ at high voltage
- Improved inductive ruggedness
- Excellent high voltage stability
- Fast switching times
- Rugged polysilicon gate cell structure
- Low input capacitance
- Extended safe operating area
- Improved high temperature reliability
- TO-220 package

PRODUCT SUMMARY

Part Number	V_{DS}	$R_{DS(on)}$	I_D
SSP6N55	550V	1.8 Ω	6A
SSP6N60	600V	1.8 Ω	6A

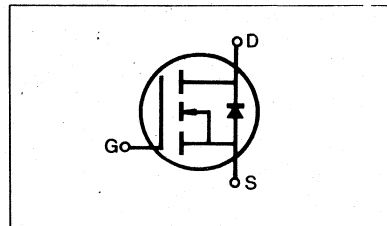
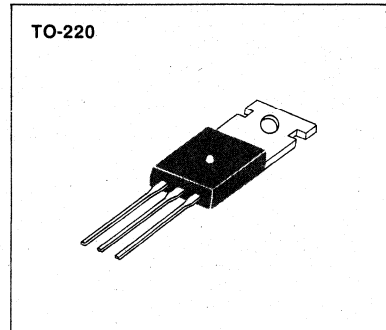

MAXIMUM RATINGS

Characteristic	Symbol	SSP6N55	SSP6N60	Unit
Drain-Source Voltage (1)	V_{DSS}	550	600	Vdc
Drain-Gate Voltage ($R_{GS}=1.0M\Omega$) (1)	V_{DGR}	550	600	Vdc
Gate-Source Voltage	V_{GS}	± 20		Vdc
Continuous Drain Current $T_C=25^\circ C$	I_D	6.0	6.0	Adc
Continuous Drain Current $T_C=100^\circ C$	I_D	4.0	4.0	Adc
Drain Current—Pulsed (3)	I_{DM}	24	24	Adc
Gate Current—Pulsed	I_{GM}	± 1.5		Adc
Total Power Dissipation @ $T_C=25^\circ C$	P_D	125		Watts
Derate above $25^\circ C$		1.0		W/ $^\circ C$
Operating and Storage Junction Temperature Range	T_J, T_{stg}	-55 to 150		$^\circ C$
Maximum Lead Temp. for Soldering Purposes, 1/8" from case for 5 seconds	T_L	300		$^\circ C$

Notes: (1) $T_J=25^\circ C$ to $150^\circ C$

(2) Pulse test: Pulse width $\leq 300\mu s$, Duty Cycle $\leq 2\%$

(3) Repetitive rating: Pulse width limited by max. junction temperature

ELECTRICAL CHARACTERISTICS (T_C=25°C unless otherwise specified)

Characteristic	Symbol	Type	Min	Typ	Max	Units	Test Conditions
Drain-Source Breakdown Voltage	BV _{DSS}	SSP6N55 SSP6N60	550 600	—	—	V	V _{GS} =0V I _D =250μA
Gate Threshold Voltage	V _{GS(th)}	ALL	2.0	—	4.5	V	V _{DS} =V _{GS} , I _D =250μA
Gate-Source Leakage Forward	I _{GSS}	ALL	—	—	100	nA	V _{GS} =20V
Gate-Source Leakage Reverse	I _{GSS}	ALL	—	—	-100	nA	V _{GS} =-20V
Zero Gate Voltage Drain Current	I _{DSS}	ALL	—	—	250	μA	V _{DS} =Max. Rating, V _{GS} =0V
			—	—	1000	μA	V _{DS} =Max. Rating×0.8, V _{GS} =0V, T _C =125°C
On-State Drain-Source Current (2)	I _{D(on)}	ALL	6.0			A	V _{DS} >I _{D(on)} ×R _{DS(on) max.} , V _{GS} =10V
Static Drain-Source On-State Resistance (2)	R _{DS(on)}	ALL	—	1.15	1.8	Ω	V _{GS} =10V, I _D =3.0A
Forward Transconductance (2)	g _{fs}	ALL	3.0	4.8	—	S	V _{DS} >I _{D(on)} ×R _{DS(on) max.} , I _D =3.0A
Input Capacitance	C _{iss}	ALL	—	1100	1800	pF	
Output Capacitance	C _{oss}	ALL	—	170	350	pF	V _{GS} =0V, V _{DS} =25V, f=1.0MHz
Reverse Transfer Capacitance	C _{rss}	ALL	—	60	150	pF	
Turn-On Delay Time	t _{d(on)}	ALL	—	—	60	ns	
Rise Time	t _r	ALL	—	—	150	ns	
Turn-Off Delay Time	t _{d(off)}	ALL	—	—	200	ns	
Fall Time	t _f	ALL	—	—	120	ns	
Total Gate Charge (Gate-Source Plus Gate-Drain)	Q _g	ALL	—	—	40	nC	
Gate-Source Charge	Q _{gs}	ALL	—	—	15	nC	
Gate-Drain ("Miller") Charge	Q _{gd}	ALL	—	—	25	nC	

V_{DD}=0.5BV_{DSS}, I_D=3.0A, Z_O=4.7Ω
(MOSFET switching times are essentially independent of operating temperature.)

V_{GS}=10V, I_D=7.5A, V_{DS}=0.8 Max. Rating (Gate charge is essentially independent of operating temperature.)

THERMAL RESISTANCE

Junction-to-Case	R _{thJC}	ALL	—	—	1.0	K/W	
Case-to-Sink	R _{thCS}	ALL	—	1.0	—	K/W	Mounting surface flat, smooth, and greased
Junction-to-Ambient	R _{thJA}	ALL	—	—	80	K/W	Free Air Operation

SOURCE-DRAIN DIODE RATINGS AND CHARACTERISTICS

Characteristic	Symbol	Type	Min	Typ	Max	Units	Test Conditions
Continuous Source Current (Body Diode)	I _S	ALL	—	—	6.0	A	Modified MOSFET symbol showing the integral reverse P-N junction rectifier
Pulse Source Current (Body Diode) (3)	I _{SM}	ALL	—	—	24.0	A	
Diode Forward Voltage (2)	V _{SD}	ALL	—	—	1.5	V	T _C =25°C, I _S =6.0A, V _{GS} =0V
Reverse Recovery Time	t _{rr}	ALL	—	800	—	ns	T _J =150°C, I _F =6.0A, dI _F /dt=100A/μs

Notes: (1) T_J=25°C to 150°C

(2) Pulse test: Pulse width≤300μs, Duty Cycle≤2%

(3) Repetitive rating: Pulse width limited by max. junction temperature

SSP6N55/6N60

N-CHANNEL POWER MOSFETS

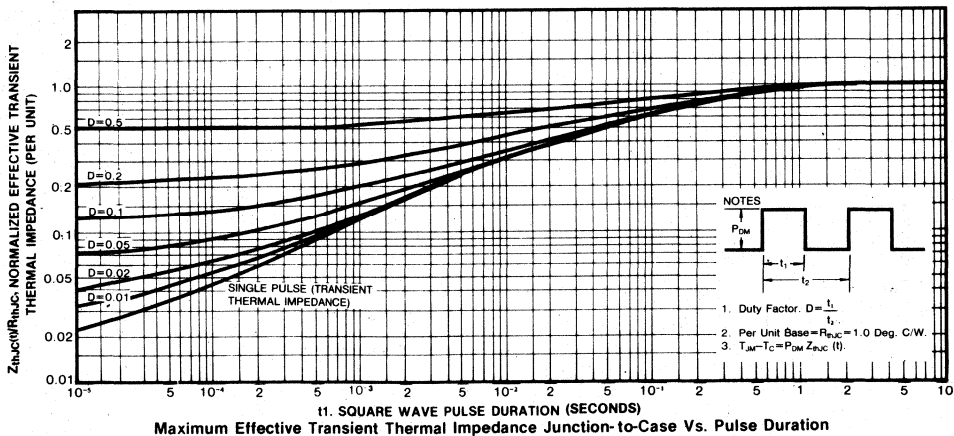
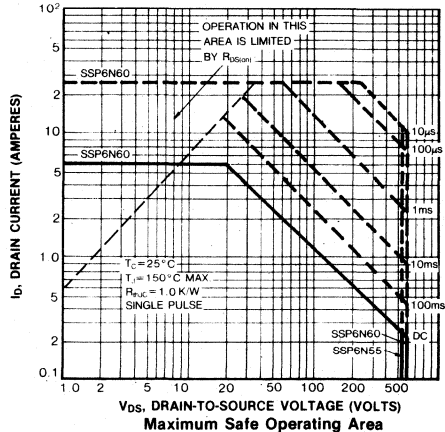
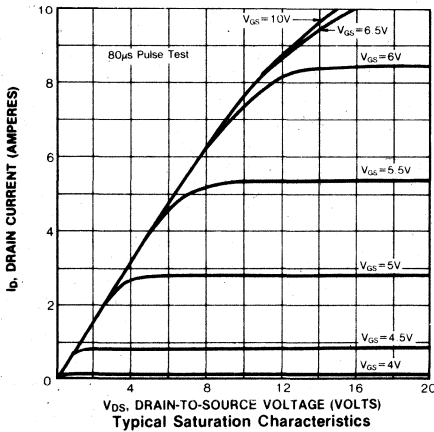
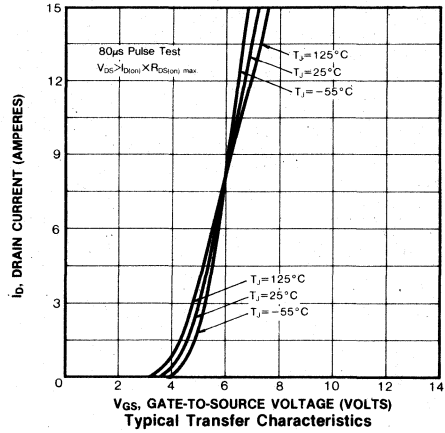
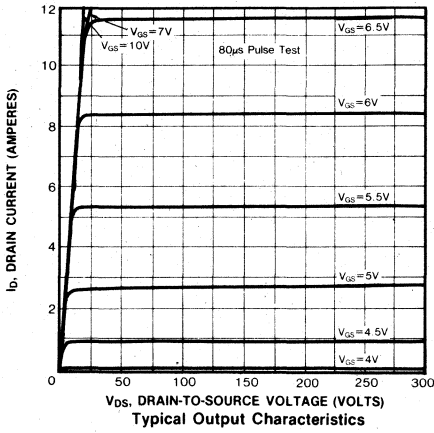

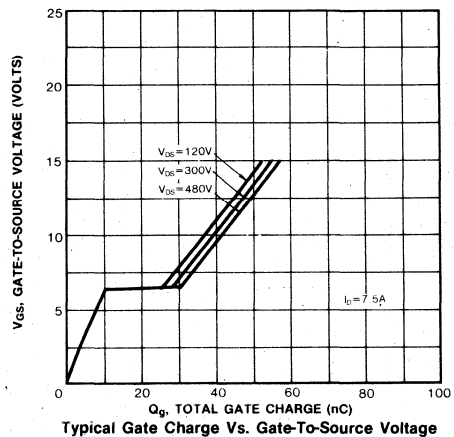
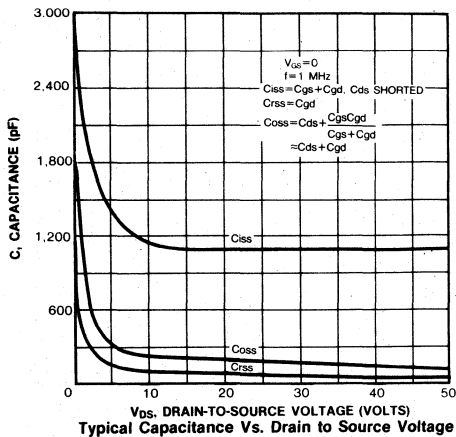
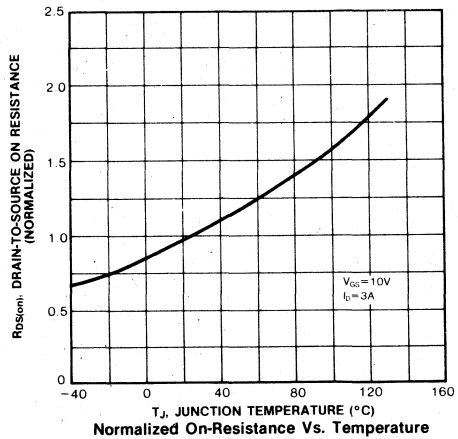
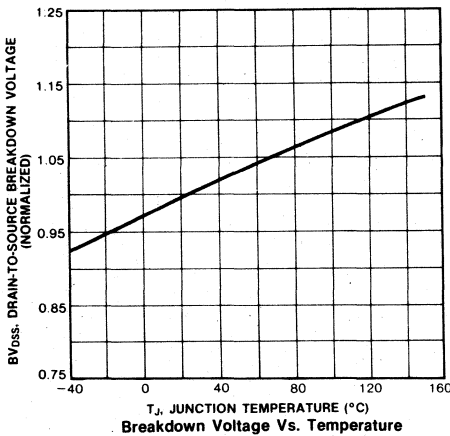
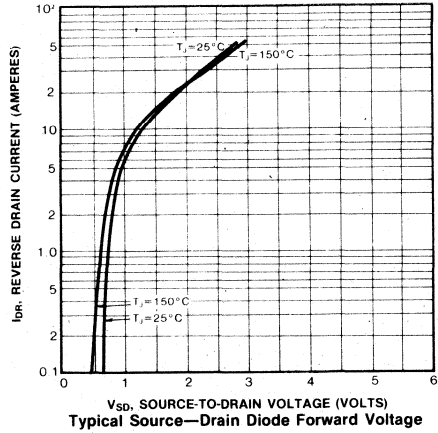
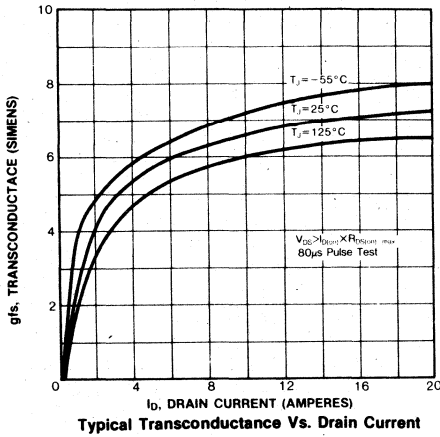

4

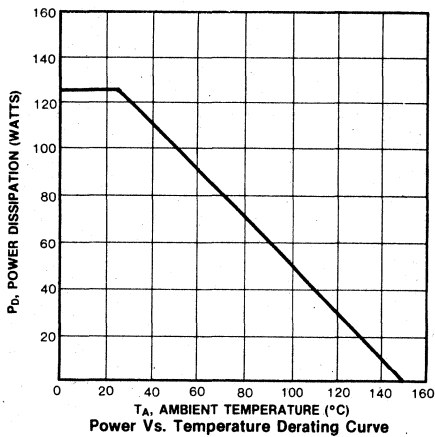
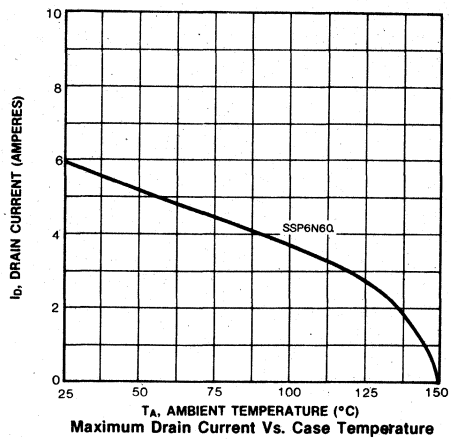
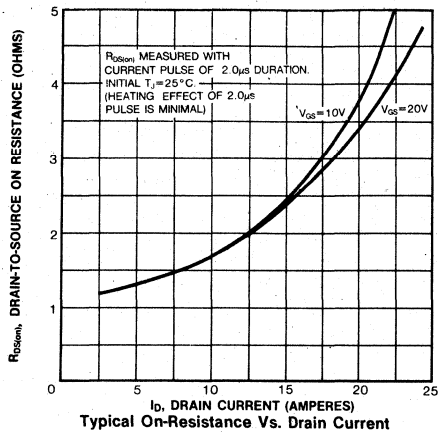

SSM40N15/40N20 SSH40N15/40N20

N-CHANNEL POWER MOSFETS

Preliminary Specifications

150 Volt, 0.08 Ohm SFET

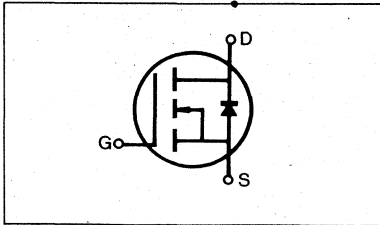

FEATURES

- Low $R_{DS(on)}$
- Improved inductive ruggedness
- Fast switching times
- Rugged polysilicon gate cell structure
- Low input capacitance
- Extended safe operating area
- Improved high temperature reliability

PRODUCT SUMMARY

Part Number	V_{DS}	$R_{DS(on)}$	I_D
SSM40N15	150V	0.08 Ω	40A
SSM40N20	200V	0.08 Ω	40A
SSH40N15	150V	0.08 Ω	40A
SSH40N20	200V	0.08 Ω	40A

PACKAGE STYLE

Package Type	Part Number
TO-3	SSM40N15/40N20
TO-3P	SSH40N15/40N20

4

MAXIMUM RATINGS

Characteristic	Symbol	SSM40N15	SSM40N20	SSH40N15	SSH40N20	Unit
Drain-Source Voltage (1)	V_{DSS}	150	200	150	200	Vdc
Drain-Gate Voltage ($R_{GS}=1.0M\Omega$) (1)	V_{DGR}	150	200	150	200	Vdc
Gate-Source Voltage	V_{GS}	± 20				Vdc
Continuous Drain Current $T_C=25^\circ C$	I_D	40	40	40	40	Adc
Continuous Drain Current $T_C=100^\circ C$	I_D	25	25	25	25	Adc
Drain Current—Pulsed (3)	I_{DM}	160	160	160	160	Adc
Gate Current—Pulsed	I_{GM}	± 1.5				Adc
Total Power Dissipation @ $T_C=25^\circ C$ Derate above $25^\circ C$	P_D	200 1.6				Watts W/ $^\circ C$
Operating and Storage Junction Temperature Range	T_J, T_{stg}	-55 to 150				$^\circ C$
Maximum Lead Temp. for Soldering Purposes, 1/8" from case for 5 seconds	T_L	300				$^\circ C$

- Notes:** (1) $T_J=25^\circ C$ to $150^\circ C$
 (2) Pulse test: Pulse width $\leq 300\mu s$, Duty Cycle $\leq 2\%$
 (3) Repetitive rating: Pulse width limited by max. junction temperature

ELECTRICAL CHARACTERISTICS ($T_C=25^\circ\text{C}$ unless otherwise specified)

Characteristic	Symbol	Type	Min	Typ	Max	Units	Test Conditions
Drain-Source Breakdown Voltage	BV_{DSS}	40N15	150	—	—	V	$V_{GS}=0V$
		40N20	200	—	—	V	$I_D=250\mu A$
Gate Threshold Voltage	$V_{GS(th)}$	ALL	2.0	—	4.5	V	$V_{DS}=V_{GS}$, $I_D=250\mu A$
Gate-Source Leakage Forward	I_{GSS}	ALL	—	—	100	nA	$V_{GS}=20V$
Gate-Source Leakage Reverse	I_{GSS}	ALL	—	—	-100	nA	$V_{GS}=20V$
Zero Gate Voltage Drain Current	I_{DSS}	ALL	—	—	250	μA	$V_{DS}=\text{Max. Rating}$, $V_{GS}=0V$
			—	—	1000	μA	$V_{DS}=\text{Max. Rating}\times 0.8$, $V_{GS}=0V$, $T_C=125^\circ\text{C}$
On-State Drain-Source Current (2)	$I_{D(on)}$	ALL	40	—	—	A	$V_{DS}>I_{D(on)}\times R_{DS(on) \text{ max.}}$, $V_{GS}=10V$
Static Drain-Source On-State Resistance (2)	$R_{DS(on)}$	ALL	—	—	0.08	Ω	$V_{GS}=10V$, $I_D=20A$
Forward Transconductance (2)	g_{fs}	ALL	10	—	—	S	$V_{DS}>I_{D(on)}\times R_{DS(on) \text{ max.}}$, $I_D=20A$
Input Capacitance	C_{iss}	ALL	—	—	4500	pF	$V_{GS}=0V$, $V_{DS}=25V$, $f=1.0\text{MHz}$
Output Capacitance	C_{oss}	ALL	—	—	800	pF	
Reverse Transfer Capacitance	C_{rss}	ALL	—	—	200	pF	
Turn-On Delay Time	$t_{d(on)}$	ALL	—	—	130	ns	$V_{DD}=0.5BV_{DSS}$, $I_D=20A$, $Z_0=4.7\Omega$ (MOSFET switching times are essentially independent of operating temperature.)
Rise Time	t_r	ALL	—	—	280	ns	
Turn-Off Delay Time	$t_{d(off)}$	ALL	—	—	630	ns	
Fall Time	t_f	ALL	—	—	210	ns	
Total Gate Charge (Gate-Source Plus Gate-Drain)	Q_g	ALL	—	—	240	nC	$V_{GS}=10V$, $I_D=50A$, $V_{DS}=0.8 \text{ Max. Rating}$ (Gate charge is essentially independent of operating temperature.)
Gate-Source Charge	Q_{gs}	ALL	—	—	80	nC	
Gate-Drain ("Miller") Charge	Q_{gd}	ALL	—	—	160	nC	

THERMAL RESISTANCE

Junction-to-Case	R_{thJC}	ALL	—	—	0.63	K/W	
Case-to-Sink	R_{thCS}	ALL	—	0.1	—	K/W	Mounting surface flat, smooth, and greased
Junction-to-Ambient	R_{thJA}	SSM40N15/20	—	—	30	K/W	Free Air Operation
		SSH40N15/20	—	—	80	K/W	

SOURCE-DRAIN DIODE RATINGS AND CHARACTERISTICS

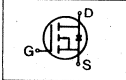
Characteristic	Symbol	Type	Min	Typ	Max	Units	Test Conditions
Continuous Source Current (Body Diode)	I_S	ALL	—	—	40	A	Modified MOSFET symbol showing the integral reverse P-N junction rectifier 
Pulse Source Current (Body Diode) (3)	I_{SM}	ALL	—	—	160	A	
Diode Forward Voltage (2)	V_{SD}	ALL	—	—	2.5	V	$T_C=25^\circ\text{C}$, $I_S=40A$, $V_{GS}=0V$
Reverse Recovery Time	t_{rr}	ALL	—	—	—	ns	$T_J=150^\circ\text{C}$, $I_F=40A$, $dI_F/dt=100A/\mu s$

Notes: (1) $T_J=25^\circ\text{C}$ to 150°C

(2) Pulse test: Pulse width $\leq 300\mu s$, Duty Cycle $\leq 2\%$

(3) Repetitive rating: Pulse width limited by max. junction temperature

SSM40N15/40N20 SSH40N15/40N20

N-CHANNEL POWER MOSFETS

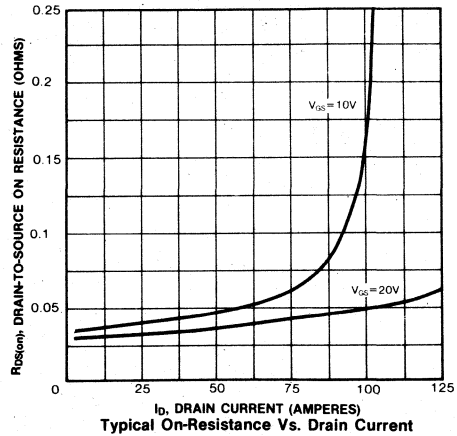
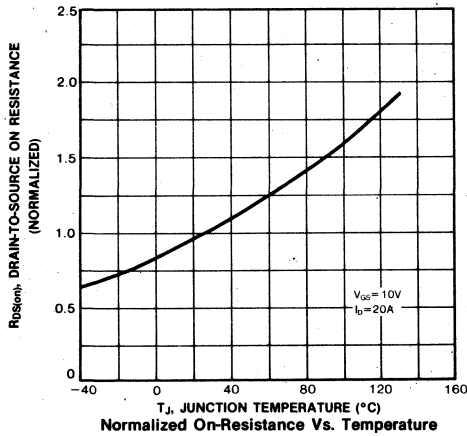
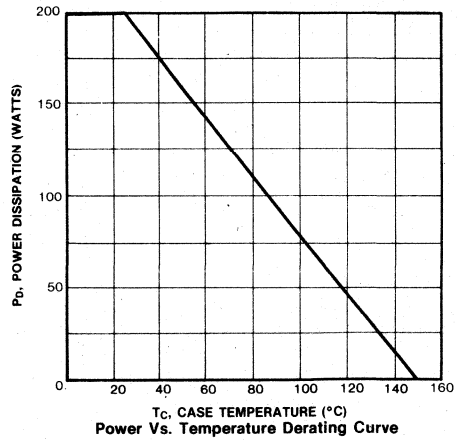
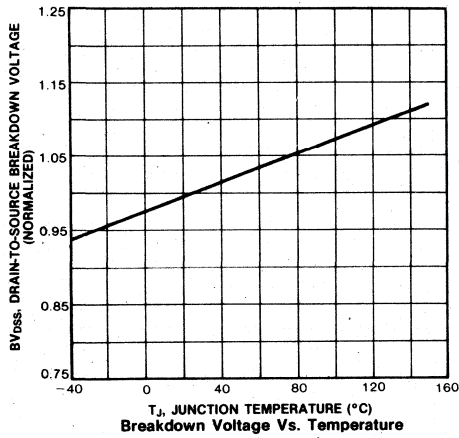

4

SSM20N45/20N50 SSH20N45/20N50

N-CHANNEL POWER MOSFETS

Preliminary Specifications

500 Volt, 0.3 Ohm SFET

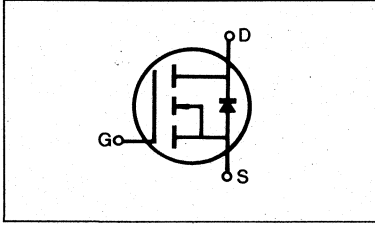

FEATURES

- Low $R_{DS(on)}$ at high voltage
- Improved inductive ruggedness
- Excellent high voltage stability
- Fast switching times
- Rugged polysilicon gate cell structure
- Low input capacitance
- Extended safe operating area
- Improved high temperature reliability

PRODUCT SUMMARY

Part Number	V_{DS}	$R_{DS(on)}$	I_D
SSM20N45	450V	0.3 Ω	20A
SSM20N50	500V	0.3 Ω	20A
SSM20N45	450V	0.3 Ω	20A
SSM20N50	500V	0.3 Ω	20A

PACKAGE STYLE

Package Type	Part Number
TO-3	SSM20N45/20N50
TO-3P	SSH20N45/20N50

MAXIMUM RATINGS

Characteristic	Symbol	SSM20N45	SSM20N50	SSH20N45	SSH20N50	Unit
Drain-Source Voltage (1)	V_{DSS}	450	500	450	500	Vdc
Drain-Gate Voltage ($R_{GS}=1.0M\Omega$)(1)	V_{DGR}	450	500	450	500	Vdc
Gate-Source Voltage	V_{GS}	± 20				Vdc
Continuous Drain Current $T_C=25^\circ C$	I_D	20	20	20	20	Adc
Continuous Drain Current $T_C=100^\circ C$	I_D	13	13	13	13	Adc
Drain Current—Pulsed (3)	I_{DM}	80	80	80	80	Adc
Gate Current—Pulsed	I_{GM}	± 1.5				Adc
Total Power Dissipation @ $T_C=25^\circ C$ Derate above $25^\circ C$	P_D	200 1.6				Watts W/ $^\circ C$
Operating and Storage Junction Temperature Range	T_J, T_{stg}	-55 to 150				$^\circ C$
Maximum Lead Temp. for Soldering Purposes, 1/8" from case for 5 seconds	T_L	300				$^\circ C$

Notes: (1) $T_J=25^\circ C$ to $150^\circ C$

(2) Pulse test: Pulse width $\leq 300\mu s$, Duty Cycle $\leq 2\%$

(3) Repetitive rating: Pulse width limited by max. junction temperature

ELECTRICAL CHARACTERISTICS ($T_C=25^\circ\text{C}$ unless otherwise specified)

Characteristic	Symbol	Type	Min	Typ	Max	Units	Test Conditions
Drain-Source Breakdown Voltage	BV _{DSS}	20N45	450	—	—	V	V _{GS} =0V I _D =250μA
		20N50	500	—	—	V	
Gate Threshold Voltage	V _{GS(th)}	ALL	2.0	—	4.5	V	V _{DS} =V _{GS} , I _D =250μA
Gate-Source Leakage Forward	I _{GSS}	ALL	—	—	100	nA	V _{GS} =20V
Gate-Source Leakage Reverse	I _{GSS}	ALL	—	—	-100	nA	V _{GS} =-20V
Zero Gate Voltage Drain Current	I _{DSS}	ALL	—	—	250	μA	V _{DS} =Max. Rating, V _{GS} =0V V _{DS} =Max. Rating×0.8, V _{GS} =0V, T _C =125°C
			—	—	1000	μA	
On-State Drain-Source Current (2)	I _{D(on)}	ALL	20	—	—	A	V _{DS} >I _{D(on)} ×R _{DS(on) max.} , V _{GS} =10V
Static Drain-Source On-State Resistance (2)	R _{DS(on)}	ALL	—	—	0.3	Ω	V _{GS} =10V, I _D =10A
Forward Transconductance (2)	g _{fs}	ALL	7.0	—	—	S	V _{DS} >I _{D(on)} ×R _{DS(on) max.} , I _D =10A
Input Capacitance	C _{iss}	ALL	—	—	3800	pF	V _{GS} =0V, V _{DS} =25V, f=1.0MHz V _{DD} =0.5BV _{DSS} , I _D =10A, Z _O =4.7Ω (MOSFET switching times are essentially independent of operating temperature.)
Output Capacitance	C _{oss}	ALL	—	—	550	pF	
Reverse Transfer Capacitance	C _{rss}	ALL	—	—	140	pF	
Turn-On Delay Time	t _{d(on)}	ALL	—	—	130	ns	
Rise Time	t _r	ALL	—	—	280	ns	
Turn-Off Delay Time	t _{d(off)}	ALL	—	—	630	ns	ns
Fall Time	t _f	ALL	—	—	210		
Total Gate Charge (Gate-Source Plus Gate-Drain)	Q _g	ALL	—	—	240	nC	V _{GS} =-15V, I _D =-3.0A, V _{DS} =0.8 Max. Rating (Gate charge is essentially independent of operating temperature.)
Gate-Source Charge	Q _{gs}	ALL	—	—	80	nC	
Gate-Drain ("Miller") Charge	Q _{gd}	ALL	—	—	160	nC	

4

THERMAL RESISTANCE

Junction-to-Case	R _{thJC}	ALL	—	—	0.63	K/W	
Case-to-Sink	R _{thCS}	ALL	—	0.1	—	K/W	Mounting surface flat, smooth, and greased
Junction-to-Ambient	R _{thJA}	SSM20N45/50	—	—	30	K/W	Free Air Operation
		SSH20N45/50	—	—	80	K/W	

SOURCE-DRAIN DIODE RATINGS AND CHARACTERISTICS

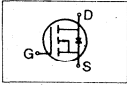
Characteristic	Symbol	Type	Min	Typ	Max	Units	Test Conditions
Continuous Source Current (Body Diode)	I _S	ALL	—	—	20	A	Modified MOSFET symbol showing the integral reverse P-N junction rectifier 
Pulse Source Current (Body Diode) (3)	I _{SM}	ALL	—	—	80	A	
Diode Forward Voltage (2)	V _{SD}	ALL	—	—	2.5	V	T _C =25°C, I _S =20A, V _{GS} =0V
Reverse Recovery Time	t _{rr}	ALL	—	—	—	ns	T _J =150°C, I _F =20A, dI _F /dt=100A/μs

- Notes:** (1) T_J=25°C to 150°C
 (2) Pulse test: Pulse width≤300μs, Duty Cycle≤2%
 (3) Repetitive rating: Pulse width limited by max. junction temperature

**SSM20N45/20N50
SSH20N45/20N50**

**N-CHANNEL
POWER MOSFETS**

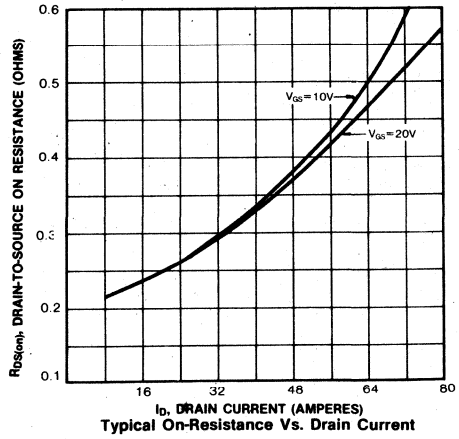
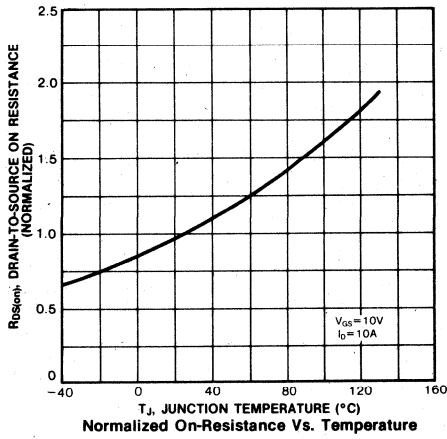
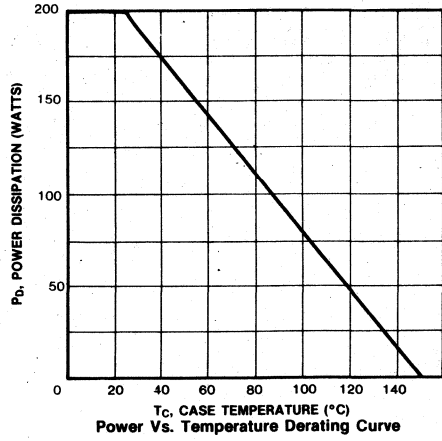
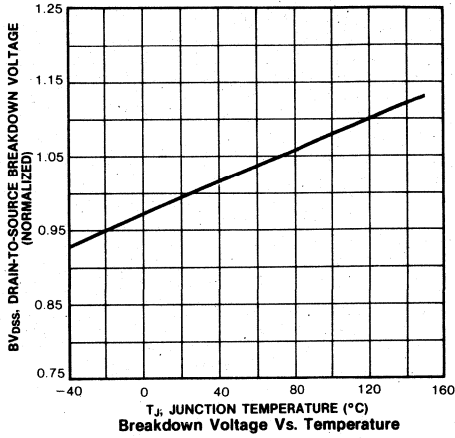

SSM15N55/15N60 SSH15N55/15N60

N-CHANNEL POWER MOSFETS

Preliminary Specifications

600 Volt, 0.5 Ohm SFET

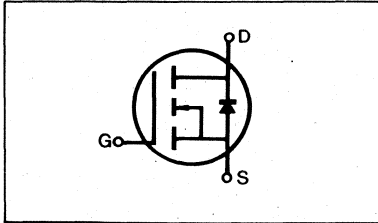

FEATURES

- Low $R_{DS(on)}$ at high voltage
- Improved inductive ruggedness
- Excellent high voltage stability
- Fast switching times
- Rugged polysilicon gate cell structure
- Low input capacitance
- Extended safe operating area
- Improved high temperature reliability

MAXIMUM RATINGS

Characteristic	Symbol	SSM15N55	SSM15N60	SSH15N55	SSH15N60	Unit
Drain-Source Voltage (1)	V_{DSS}	550	600	550	600	Vdc
Drain-Gate Voltage ($R_{GS}=1.0M\Omega$) (1)	V_{DGR}	550	600	550	600	Vdc
Gate-Source Voltage	V_{GS}	±20				Vdc
Continuous Drain Current $T_C=25^\circ C$	I_D	15	15	15	15	Adc
Continuous Drain Current $T_C=100^\circ C$	I_D	10	10	10	10	Adc
Drain Current—Pulsed (3)	I_{DM}	60	60	60	60	Adc
Gate Current—Pulsed	I_{GM}	±1.5				Adc
Total Power Dissipation @ $T_C=25^\circ C$ Derate above $25^\circ C$	P_D	200 1.6				Watts W/ $^\circ C$
Operating and Storage Junction Temperature Range	T_J, T_{stg}	-55 to 150				$^\circ C$
Maximum Lead Temp. for Soldering Purposes, 1/8" from case for 5 seconds	T_L	300				$^\circ C$

- Notes:** (1) $T_J=25^\circ C$ to $150^\circ C$
 (2) Pulse test: Pulse width $\leq 300\mu s$, Duty Cycle $\leq 2\%$
 (3) Repetitive rating: Pulse width limited by max. junction temperature

PRODUCT SUMMARY

Part Number	V_{DS}	$R_{DS(on)}$	I_D
SSM15N55	550V	0.5 Ω	15A
SSM15N60	600V	0.5 Ω	15A
SSH15N55	550V	0.5 Ω	15A
SSH15N60	600V	0.5 Ω	15A

PACKAGE STYLE

Package Type	Part Number
TO-3	SSM15N55/15N60
TO-3P	SSH15N55/15N60

ELECTRICAL CHARACTERISTICS ($T_C=25^\circ\text{C}$ unless otherwise specified)

Characteristic	Symbol	Type	Min	Typ	Max	Units	Test Conditions
Drain-Source Breakdown Voltage	BV_{DSS}	15N55	550	—	—	V	$V_{GS}=0V$
		15N60	600	—	—	V	$I_D=250\mu A$
Gate Threshold Voltage	$V_{GS(th)}$	ALL	2.0	—	4.5	V	$V_{DS}=V_{GS}$, $I_D=250\mu A$
Gate-Source Leakage Forward	I_{GSS}	ALL	—	—	100	nA	$V_{GS}=20V$
Gate-Source Leakage Reverse	I_{GSS}	ALL	—	—	-100	nA	$V_{GS}=-20V$
Zero Gate Voltage Drain Current	I_{DSS}	ALL	—	—	250	μA	$V_{DS}=\text{Max. Rating}$, $V_{GS}=0V$
			—	—	1000	μA	$V_{DS}=\text{Max. Rating} \times 0.8$, $V_{GS}=0V$, $T_C=125^\circ\text{C}$
On-State Drain-Source Current (2)	$I_{D(on)}$	ALL	15	—	—	A	$V_{DS}>I_{D(on)} \times R_{DS(on) \text{ max.}}$, $V_{GS}=10V$
Static Drain-Source On-State Resistance (2)	$R_{DS(on)}$	ALL	—	—	0.5	Ω	$V_{GS}=10V$, $I_D=8.0A$
Forward Transconductance (2)	g_{fs}	ALL	7.0	—	—	S	$V_{DS}>I_{D(on)} \times R_{DS(on) \text{ max.}}$, $I_D=8.0A$
Input Capacitance	C_{iss}	ALL	—	—	3800	pF	$V_{GS}=0V$, $V_{DS}=25V$, $f=1.0\text{MHz}$
Output Capacitance	C_{oss}	ALL	—	—	550	pF	
Reverse Transfer Capacitance	C_{rss}	ALL	—	—	140	pF	
Turn-On Delay Time	$t_{d(on)}$	ALL	—	—	130	ns	
Rise Time	t_r	ALL	—	—	280	ns	$V_{DD}=0.5BV_{DSS}$, $I_D=8.0A$, $Z_O=4.7\Omega$ (MOSFET switching times are essentially independent of operating temperature.)
Turn-Off Delay Time	$t_{d(off)}$	ALL	—	—	630	ns	
Fall Time	t_f	ALL	—	—	210	ns	
Total Gate Charge (Gate-Source Plus Gate-Drain)	Q_g	ALL	—	—	240	nC	$V_{GS}=10V$, $I_D=18A$, $V_{DS}=0.8 \text{ Max.}$ Rating (Gate charge is essentially independent of operating temperature.)
Gate-Source Charge	Q_{gs}	ALL	—	—	80	nC	
Gate-Drain ("Miller") Charge	Q_{gd}	ALL	—	—	160	nC	

THERMAL RESISTANCE

Junction-to-Case	R_{thJC}	ALL	—	—	0.63	K/W	
Case-to-Sink	R_{thCS}	ALL	—	0.1	—	K/W	Mounting surface flat, smooth, and greased
Junction-to-Ambient	R_{thJA}	SSM15N55/60	—	—	30	K/W	Free Air Operation
		SSH15N55/60	—	—	80	K/W	

SOURCE-DRAIN DIODE RATINGS AND CHARACTERISTICS

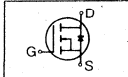
Characteristic	Symbol	Type	Min	Typ	Max	Units	Test Conditions
Continuous Source Current (Body Diode)	I_S	ALL	—	—	15	A	Modified MOSFET symbol showing the integral reverse P-N junction rectifier 
Pulse Source Current (Body Diode) (3)	I_{SM}	ALL	—	—	60	A	
Diode Forward Voltage (2)	V_{SD}	ALL	—	—	2.5	V	$T_C=25^\circ\text{C}$, $I_S=15A$, $V_{GS}=0V$
Reverse Recovery Time	t_{rr}	ALL	—	—	—	ns	$T_J=150^\circ\text{C}$, $I_F=15A$, $dI_F/dt=100A/\mu s$

- Notes:** (1) $T_J=25^\circ\text{C}$ to 150°C
(2) Pulse test: Pulse width $\leq 300\mu s$, Duty Cycle $\leq 2\%$
(3) Repetitive rating: Pulse width limited by max. junction temperature

SSM15N55/15N60
SSH15N55/15N60

N-CHANNEL
POWER MOSFETS

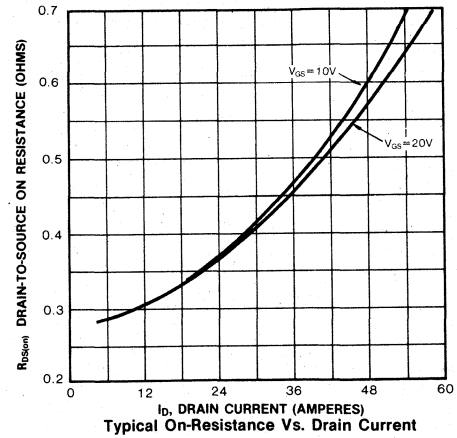
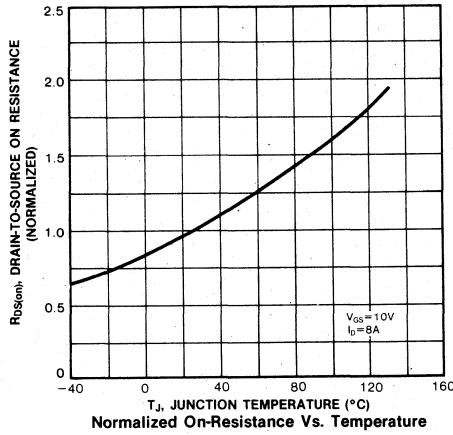
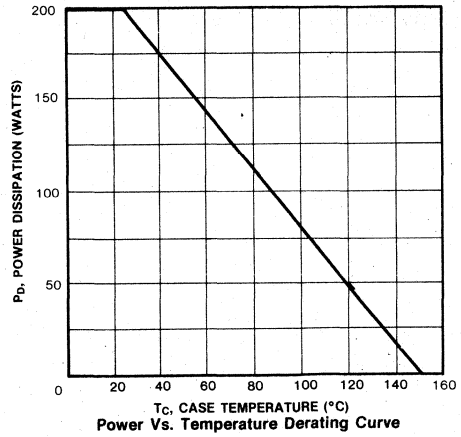
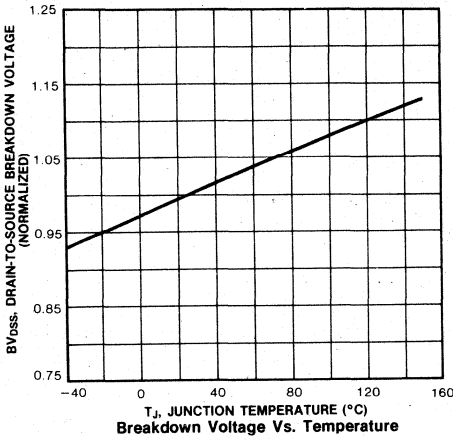

SSM25N35/25N40 SSH25N35/25N40

N-CHANNEL POWER MOSFETS

Preliminary Specifications

400 Volt, 0.25 Ohm SFET

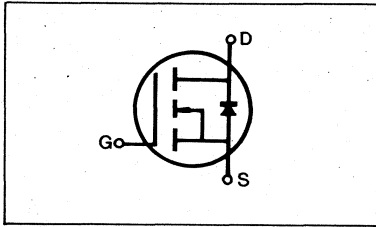

FEATURES

- Low $R_{DS(on)}$
- Improved inductive ruggedness
- Fast switching times
- Rugged polysilicon gate cell structure
- Lower input capacitance
- Extended safe operating area
- Improved high temperature reliability

PRODUCT SUMMARY

Part Number	V_{DS}	$R_{DS(on)}$	I_D
SSM25N35	350V	0.25	25A
SSM25N40	400V	0.25	25A
SSH25N35	350V	0.25	25A
SSH25N40	400V	0.25	25A

PACKAGE STYLE

Package Type	Part Number
TO-3	SSM25N35/25N40
TO-3P	SSH25N35/25N40

MAXIMUM RATINGS

Characteristic	Symbol	SSM25N35	SSM25N40	SSH25N35	SSH25N40	Unit
Drain-Source Voltage (1)	V_{DSS}	350	400	350	400	Vdc
Drain-Gate Voltage ($R_{GS}=1.0M\Omega$) (1)	V_{DGR}	350	400	350	400	Vdc
Gate-Source Voltage	V_{GS}	± 20				Vdc
Continuous Drain Current $T_C=25^\circ C$	I_D	25	25	25	25	Adc
Continuous Drain Current $T_C=100^\circ C$	I_D	16	16	16	16	Adc
Drain Current—Pulsed (3)	I_{DM}	100	100	100	100	Adc
Gate Current—Pulsed	I_{GM}	± 1.5				Adc
Total Power Dissipation @ $T_C=25^\circ C$ Derate above $25^\circ C$	P_D	200 1.6				Watts W/ $^\circ C$
Operating and Storage Junction Temperature Range	T_J, T_{stg}	-55 to 150				$^\circ C$
Maximum Lead Temp. for Soldering Purposes, 1/8" from case for 5 seconds	T_L	300				$^\circ C$

- Notes:** (1) $T_J=25^\circ C$ to $150^\circ C$
 (2) Pulse test: Pulse width $\leq 300\mu s$, Duty Cycle $\leq 2\%$
 (3) Repetitive rating: Pulse width limited by max. junction temperature

ELECTRICAL CHARACTERISTICS (T_C=25°C unless otherwise specified)

Characteristic	Symbol	Type	Min	Typ	Max	Units	Test Conditions
Drain-Source Breakdown Voltage	BV _{DSS}	25N35	350	—	—	V	V _{GS} =0V
		25N40	400	—	—	V	I _D =250μA
Gate Threshold Voltage	V _{GS(th)}	ALL	2.0	—	4.5	V	V _{DS} =V _{GS} , I _D =250μA
Gate-Source Leakage Forward	I _{GSS}	ALL	—	—	100	nA	V _{GS} =20V
Gate-Source Leakage Reverse	I _{GSS}	ALL	—	—	-100	nA	V _{GS} =-20V
Zero Gate Voltage Drain Current	I _{DSS}	ALL	—	—	250	μA	V _{DS} =Max. Rating V _{GS} =0
			—	—	1000	μA	V _{DS} =Max. Rating×0.8, V _{GS} =0V, T _C =125°C
On-State Drain-Source Current (2)	I _{D(on)}	ALL	25	—	—	A	V _{DS} >I _{D(on)} ×R _{DS(on) max.} , V _{GS} =10V
Static Drain-Source On-State Resistance (2)	R _{DS(on)}	ALL	—	—	0.25	Ω	V _{GS} =10V, I _D =13A
Forward Transconductance (2)	g _{fs}	ALL	7.0	—	—	S	V _{DS} >I _{D(on)} ×R _{DS(on) max.} , I _D =13A
Input Capacitance	C _{iss}	ALL	—	—	3800	pF	V _{GS} =0V, V _{DS} =25V, f=1.0MHz
Output Capacitance	C _{oss}	ALL	—	—	550	pF	
Reverse Transfer Capacitance	C _{rss}	ALL	—	—	140	pF	
Turn-On Delay Time	t _{d(on)}	ALL	—	—	130	ns	V _{DD} =0.5BV _{DSS} , I _D =13A, Z _O =4.7Ω (MOSFET switching times are essentially independent of operating temperature.)
Rise Time	t _r	ALL	—	—	280	ns	
Turn-Off Delay Time	t _{d(off)}	ALL	—	—	630	ns	
Fall Time	t _f	ALL	—	—	210	ns	
Total Gate Charge (Gate-Source Plus Gate-Drain)	Q _g	ALL	—	—	240	nC	V _{GS} =10V, I _D =30A, V _{DS} =0.8 Max. Rating (Gate charge is essentially independent of operating temperature.)
Gate-Source Charge	Q _{gs}	ALL	—	—	80	nC	of operating temperature.)
Gate-Drain ("Miller") Charge	Q _{gd}	ALL	—	—	160	nC	

THERMAL RESISTANCE

Junction-to-Case	R _{thJC}	ALL	—	—	0.63	K/W	
Case-to-Sink	R _{thCS}	ALL	—	0.1	—	K/W	Mounting surface flat, smooth, and greased
Junction-to-Ambient	R _{thJA}	SSM25N35/40	—	—	30	K/W	Free Air Operation
		SSH25N35/40	—	—	80	K/W	

SOURCE-DRAIN DIODE RATINGS AND CHARACTERISTICS

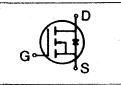
Characteristic	Symbol	Type	Min	Typ	Max	Units	Test Conditions
Continuous Source Current (Body Diode)	I _S	ALL	—	—	25	A	Modified MOSFET symbol showing the integral reverse P-N junction rectifier 
Pulse Source Current (Body Diode) (3)	I _{SM}	ALL	—	—	100	A	
Diode Forward Voltage (2)	V _{SD}	ALL	—	—	2.5	V	T _C =25°C, I _S =25A, V _{GS} =0V
Reverse Recovery Time	t _{rr}	ALL	—	—	—	ns	T _J =150°C, I _F =25A, dI _F /dt=100A/μs

- Notes:** (1) T_J=25°C to 150°C
(2) Pulse test: Pulse width≤300μs, Duty Cycle≤2%
(3) Repetitive rating: Pulse width limited by max. junction temperature

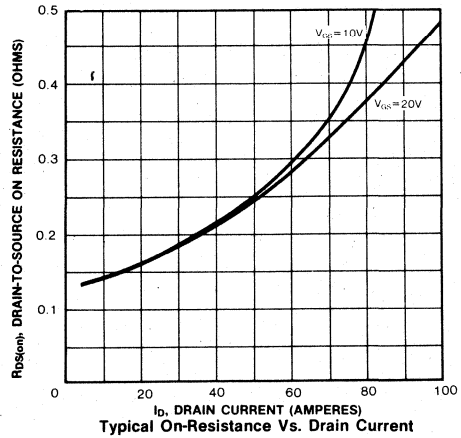
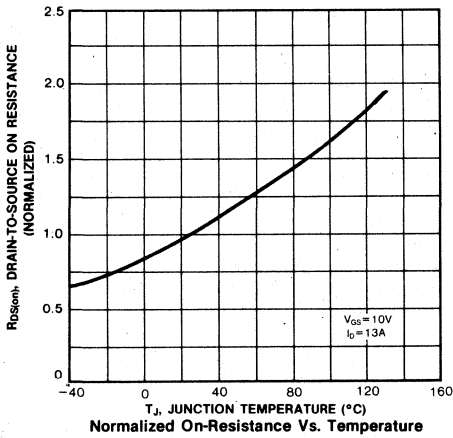
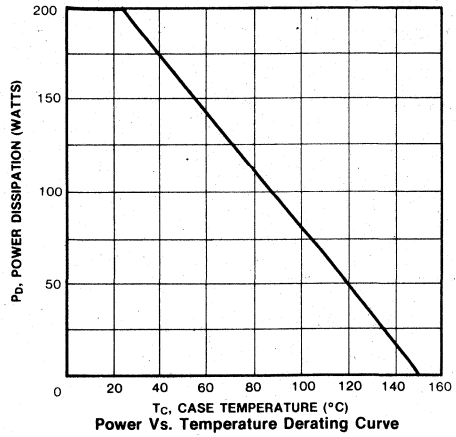
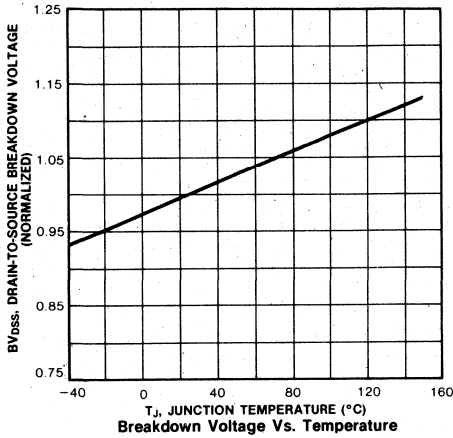

SSM10N70 SSH10N70

N-CHANNEL POWER MOSFETS

Preliminary Specifications

700 Volt, 1.0 Ohm SFET

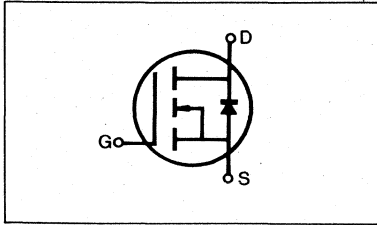

FEATURES

- Low $R_{DS(on)}$ at high voltage
- Improved inductive ruggedness
- Excellent high voltage stability
- Fast switching times
- Rugged polysilicon gate cell structure
- Low input capacitance
- Extended safe operating area
- Improved high temperature reliability

PRODUCT SUMMARY

Part Number	V_{DS}	$R_{DS(on)}$	I_D
SSM10N70	700V	1.0 Ω	10A
SSH10N70	700V	1.0 Ω	10A

PACKAGE STYLE

Package Type	Part Number
TO-3	SSM10N70
TO-3P	SSH10N70

MAXIMUM RATINGS

Characteristic	Symbol	SSM10N70	SSH10N70	Unit
Drain-Source Voltage (1)	V_{DSS}	700	700	Vdc
Drain-Gate Voltage ($R_{GS}=1.0M\Omega$) (1)	V_{DGR}	700	700	Vdc
Gate-Source Voltage	V_{GS}	± 20		Vdc
Continuous Drain Current $T_C=25^\circ C$	I_D	10	10	Adc
Continuous Drain Current $T_C=100^\circ C$	I_D	6.5	6.5	Adc
Drain Current—Pulsed (3)	I_{DM}	40	40	Adc
Gate Current—Pulsed	I_{GM}	± 1.5		Adc
Total Power Dissipation @ $T_C=25^\circ C$	P_D	200		Watts
Derate above $25^\circ C$		1.6		W/ $^\circ C$
Operating and Storage Junction Temperature Range	T_J, T_{stg}	-55 to 150		$^\circ C$
Maximum Lead Temp. for Soldering Purposes, 1/8" from case for 5 seconds	T_L	300		$^\circ C$

- Notes: (1) $T_J=25^\circ C$ to $150^\circ C$
 (2) Pulse test: Pulse width $\leq 300\mu s$, Duty Cycle $\leq 2\%$
 (3) Repetitive rating: Pulse width limited by max. junction temperature

ELECTRICAL CHARACTERISTICS ($T_C=25^\circ\text{C}$ unless otherwise specified)

Characteristic	Symbol	Type	Min	Typ	Max	Units	Test Conditions
Drain-Source Breakdown Voltage	BV_{DSS}	ALL	700	—	—	V	$V_{GS}=0V$ $I_D=250\mu A$
Gate Threshold Voltage	$V_{GS(th)}$	ALL	2.0	—	4.5	V	$V_{DS}=V_{GS}$, $I_D=250\mu A$
Gate-Source Leakage Forward	I_{GSS}	ALL	—	—	100	nA	$V_{GS}=20V$
Gate-Source Leakage Reverse	I_{GSS}	ALL	—	—	-100	nA	$V_{GS}=-20V$
Zero Gate Voltage Drain Current	I_{DSS}	ALL	—	—	250	μA	$V_{DS}=\text{Max. Rating}$, $V_{GS}=0V$
			—	—	1000	μA	$V_{DS}=\text{Max. Rating} \times 0.8$, $V_{GS}=0V$, $T_C=125^\circ\text{C}$
On-State Drain-Source Current (2)	$I_{D(on)}$	ALL	10	—	—	A	$V_{DS} > I_{D(on)} \times R_{DS(on) \text{ max.}}$, $V_{GS}=10V$
Static Drain-Source On-State Resistance (2)	$R_{DS(on)}$	SSM10N70 SSH10N70	—	—	3.0	Ω	$V_{GS}=10V$, $I_D=5.0A$
Forward Transconductance (2)	g_{fs}	ALL	7.0	—	—	S	$V_{DS} > I_{D(on)} \times R_{DS(on) \text{ max.}}$, $I_D=5.0A$
Input Capacitance	C_{iss}	ALL	—	—	3800	pF	
Output Capacitance	C_{oss}	ALL	—	—	550	pF	$V_{GS}=0V$, $V_{DS}=25V$, $f=1.0\text{MHz}$
Reverse Transfer Capacitance	C_{rss}	ALL	—	—	140	pF	
Turn-On Delay Time	$t_{d(on)}$	ALL	—	—	130	ns	
Rise Time	t_r	ALL	—	—	280	ns	
Turn-Off Delay Time	$t_{d(off)}$	ALL	—	—	630	ns	
Fall Time	t_f	ALL	—	—	210	ns	
Total Gate Charge (Gate-Source Plus Gate-Drain)	Q_g	ALL	—	—	240	nC	$V_{GS}=10V$, $I_D=13A$, $V_{DS}=0.8 \text{ Max. Rating}$ (Gate charge is essentially independent of operating temperature.)
Gate-Source Charge	Q_{gs}	ALL	—	—	80	nC	
Gate-Drain ("Miller") Charge	Q_{gd}	ALL	—	—	160	nC	

THERMAL RESISTANCE

Junction-to-Case	R_{thJC}	ALL	—	—	0.63	K/W	
Case-to-Sink	R_{thCS}	ALL	—	0.1	—	K/W	Mounting surface flat, smooth, and greased
Junction-to-Ambient	R_{thJA}	SSM10N70	—	—	30	K/W	Free Air Operation
		SSH10N70	—	—	80	K/W	

SOURCE-DRAIN DIODE RATINGS AND CHARACTERISTICS

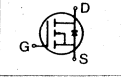
Characteristic	Symbol	Type	Min	Typ	Max	Units	Test Conditions
Continuous Source Current (Body Diode)	I_S	ALL	—	—	10	A	Modified MOSFET symbol showing the integral reverse P-N junction rectifier 
Pulse Source Current (Body Diode) (3)	I_{SM}	ALL	—	—	40	A	
Diode Forward Voltage (2)	V_{SD}	ALL	—	—	2.5	V	$T_C=25^\circ\text{C}$, $I_S=10A$, $V_{GS}=0V$
Reverse Recovery Time	t_{rr}	ALL	—	—	—	ns	$T_J=150^\circ\text{C}$, $I_F=10A$, $dI_F/dt=100A/\mu s$

- Notes:** (1) $T_J=25^\circ\text{C}$ to 150°C
 (2) Pulse test: Pulse width $\leq 300\mu s$, Duty Cycle $\leq 2\%$
 (3) Repetitive rating: Pulse width limited by max. junction temperature

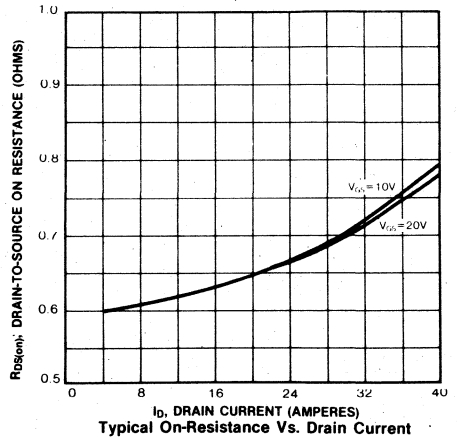
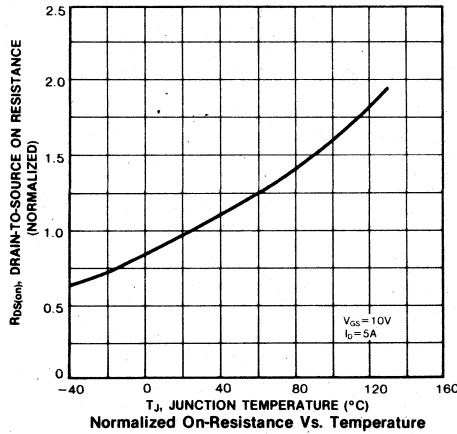
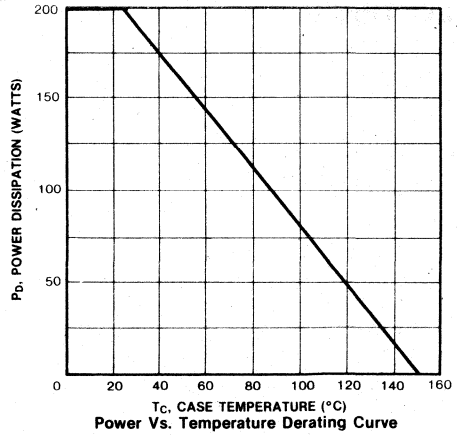
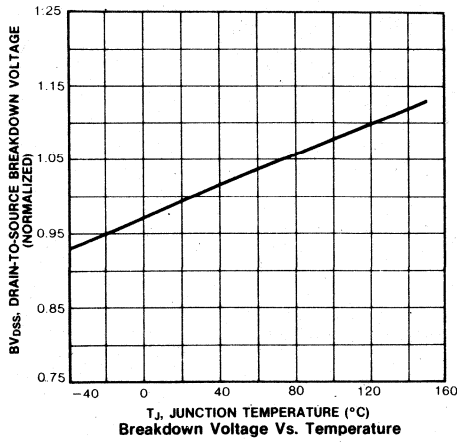

IRF9510/9511/9512/9513

P-CHANNEL POWER MOSFETS

Preliminary Specifications

– 100 Volt, 1.2 Ohm SFET

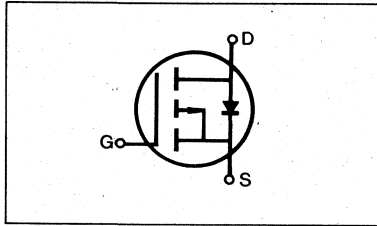

PRODUCT SUMMARY

Part Number	V _{DS}	R _{DS(on)}	I _D
IRF9510	–100V	1.2Ω	–3.0A
IRF9511	–60V	1.2Ω	–3.0A
IRF9512	–100V	1.6Ω	–2.5A
IRF9513	–60V	1.6Ω	–2.5A

FEATURES

- Low R_{DS(on)}
- Improved inductive ruggedness
- Fast switching times
- Rugged polysilicon gate cell structure
- Low input capacitance
- Extended safe operating area
- Improved high temperature reliability

PACKAGE STYLE

Package Type	Part Number
TO-220	IRF9510/9511/9512/9513

MAXIMUM RATINGS

Characteristic	Symbol	IRF				Unit
		9510	9511	9512	9513	
Drain-Source Voltage (1)	V _{DSS}	–100	–60	–100	–60	Vdc
Drain-Gate Voltage (R _{GS} =1.0MΩ)(1)	V _{DGR}	–100	–60	–100	–60	Vdc
Gate-Source Voltage	V _{GS}	±20				Vdc
Continuous Drain Current T _C =25°C	I _D	–3.0	–3.0	–2.5	–2.5	Adc
Continuous Drain Current T _C =100°C	I _D	–2.0	–2.0	–1.5	–1.5	Adc
Drain Current—Pulsed (3)	I _{DM}	–12	–12	–10	–10	Adc
Gate Current—Pulsed	I _{GM}	±1.5				Adc
Total Power Dissipation @ T _C =25°C Derate above 25°C	P _D	20 0.16				Watts W/°C
Operating and Storage Junction Temperature Range	T _J , T _{stg}	–55 to 150				°C
Maximum Lead Temp. for Soldering Purposes, 1/8" from case for 5 seconds	T _L	300				°C

- Notes:** (1) T_J=25°C to 150°C
 (2) Pulse test: Pulse width≤300μs, Duty Cycle≤2%
 (3) Repetitive rating: Pulse width limited by max. junction temperature

ELECTRICAL CHARACTERISTICS (T_C=25°C unless otherwise specified)

Characteristic	Symbol	Type	Min	Typ	Max	Units	Test Conditions
Drain-Source Breakdown Voltage	BV _{DSS}	IRF9510	-100	—	—	V	V _{GS} =0V I _D =-250μA
		IRF9512					
		IRF9511	-60	—	—	V	
		IRF9513					
Gate Threshold Voltage	V _{GS(th)}	ALL	-2.0	—	-4.0	V	V _{DS} =V _{GS} , I _D =-250μA
Gate-Source Leakage Forward	I _{GSS}	ALL	—	—	-100	nA	V _{GS} =-20V
Gate-Source Leakage Reverse	I _{GSS}	ALL	—	—	100	nA	V _{GS} =20V
Zero Gate Voltage Drain Current	I _{DSS}	ALL	—	—	-250	μA	V _{DS} =Max. Rating, V _{GS} =0V
			—	—	-1000	μA	V _{DS} =Max. Rating×0.8, V _{GS} =0V, T _C =125°C
On-State Drain-Source Current (2)	I _{D(on)}	IRF9510	-3.0	—	—	A	V _{DS} >I _{D(on)} ×R _{DS(on) max.} , V _{GS} =-10V
		IRF9511					
		IRF9512	-2.5	—	—	A	
		IRF9513					
Static Drain-Source On-State Resistance (2)	R _{DS(on)}	IRF9510	—	—	1.2	Ω	V _{GS} =-10V, I _D =-1.5A
		IRF9511					
		IRF9512	—	—	1.6	Ω	
		IRF9513					
Forward Transconductance (2)	g _{fs}	ALL	0.8	—	—	S	V _{DS} >I _{D(on)} ×R _{DS(on) max.} , I _D =-1.5A
Input Capacitance	C _{iss}	ALL	—	—	250	pF	V _{GS} =0V, V _{DS} =-25V, f=1.0MHz
Output Capacitance	C _{oss}	ALL	—	—	100	pF	
Reverse Transfer Capacitance	C _{rss}	ALL	—	—	35	pF	
Turn-On Delay Time	t _{d(on)}	ALL	—	—	30	ns	
Rise Time	t _r	ALL	—	—	60	ns	V _{DD} =0.5BV _{DSS} , I _D =-1.5A, Z _O =50Ω, (MOSFET switching times are essentially independent of operating temperature.)
Turn-Off Delay Time	t _{d(off)}	ALL	—	—	40	ns	
Fall Time	t _f	ALL	—	—	40	ns	
Total Gate Charge (Gate-Source Plus Gate-Drain)	Q _g	ALL	—	—	11	nC	V _{GS} =-15V, I _D =-4.0A, V _{DS} =0.8 Max. Rating (Gate charge is essentially independent of operating temperature.)
Gate-Source Charge	Q _{gs}	ALL	—	—	4	nC	
Gate-Drain ("Miller") Charge	Q _{gd}	ALL	—	—	7	nC	

4

THERMAL RESISTANCE

Junction-to-Case	R _{thJC}	ALL	—	—	6.4	K/W	
Case-to-Sink	R _{thCS}	ALL	—	1.0	—	K/W	Mounting surface flat, smooth, and greased
Junction-to-Ambient	R _{thJA}	ALL	—	—	80	K/W	Free Air Operation

Notes: (1) T_J=25°C to 150°C

(2) Pulse test: Pulse width≤300μs, Duty Cycle≤2%

(3) Repetitive rating: Pulse width limited by max. junction temperature

SOURCE-DRAIN DIODE RATINGS AND CHARACTERISTICS

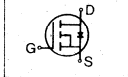
Characteristic	Symbol	Type	Min	Typ	Max	Units	Test Conditions
Continuous Source Current (Body Diode)	I _S	IRF9510	—	—	-3.0	A	Modified MOSFET symbol showing the integral reverse P-N junction rectifier 
		IRF9511	—	—	-2.5	A	
Pulse Source Current (Body Diode) (3)	I _{SM}	IRF9510	—	—	-12	A	
		IRF9511	—	—	-10	A	
		IRF9512	—	—	-10	A	
Diode Forward Voltage (2)	V _{SD}	IRF9510	—	—	-5.5	V	T _C =25°C, I _S =-3.0A, V _{GS} =0V
		IRF9511	—	—	-5.3	V	T _C =25°C, I _S =-2.5A, V _{GS} =0V
Reverse Recovery Time	t _{rr}	ALL	—	—	—	ns	T _J =150°C, I _F =-3.0A, dI _F /dt=100A/μs

Notes: (1) T_J=25°C to 150°C (2) Pulse test: Pulse width ≤ 300μs, Duty Cycle ≤ 2%
 (3) Repetitive rating: Pulse width limited by max. junction temperature

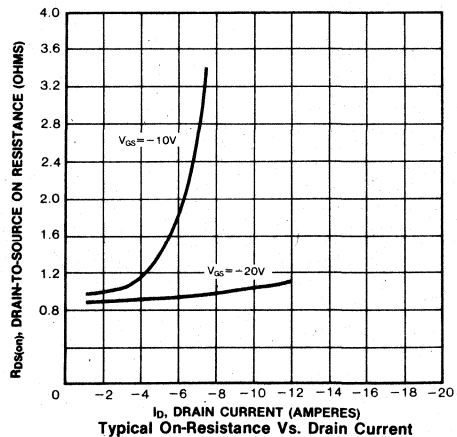
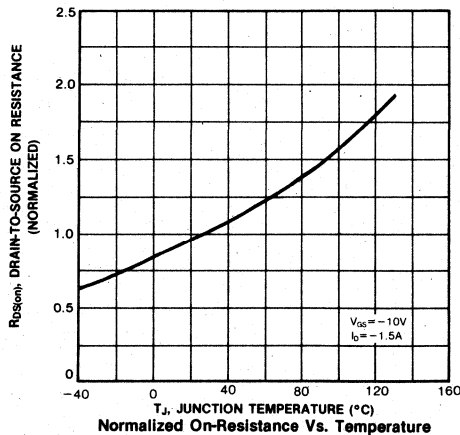
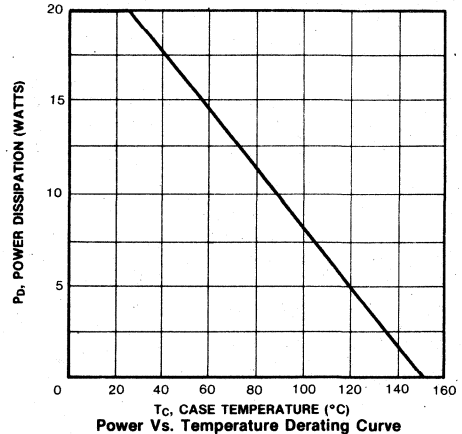
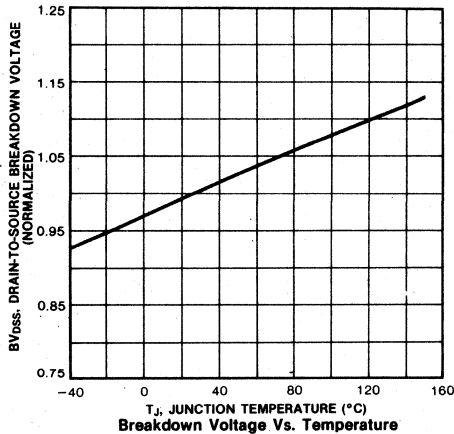

IRF9120/9121/9122/9123
IRFP9120/9121/9122/9123
IRF9520/9521/9522/9523

P-CHANNEL
POWER MOSFETS

Preliminary Specifications

- 100 Volt, 0.60 Ohm SFET

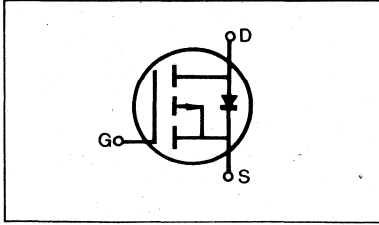

FEATURES

- Low $R_{DS(on)}$
- Improved inductive ruggedness
- Fast switching times
- Rugged polysilicon gate cell structure
- Low input capacitance
- Extended safe operating area
- Improved high temperature reliability

PRODUCT SUMMARY

Part Number	V_{DS}	$R_{DS(on)}$	I_D
IRF/IRFP9120, IRF9520	-100V	0.60 Ω	-6.0A
IRF/IRFP9121, IRF9521	-60V	0.60 Ω	-6.0A
IRF/IRFP9122, IRF9522	-100V	0.80 Ω	-5.0A
IRF/IRFP9123, IRF9523	-60V	0.80 Ω	-5.0A

PACKAGE STYLE

Package Type	Part Number
TO-3	IRF9120/9121/9122/9123
TO-3P	IRFP9120/9121/9122/9123
TO-220	IRF9520/9521/9522/9523

MAXIMUM RATINGS

Characteristic	Symbol	IRF/IRFP				Unit
		9120 9520	9121 9521	9122 9522	9123 9523	
Drain-Source Voltage (1)	V_{DSS}	-100	-60	-100	-60	Vdc
Drain-Gate Voltage ($R_{GS}=1.0M\Omega$) (1)	V_{DGR}	-100	-60	-100	-60	Vdc
Gate-Source Voltage	V_{GS}	± 20				Vdc
Continuous Drain Current $T_C=25^\circ C$	I_D	-6.0	-6.0	-5.0	-5.0	Adc
Continuous Drain Current $T_C=100^\circ C$	I_D	-4.0	-4.0	-3.5	-3.5	Adc
Drain Current—Pulsed (3)	I_{DM}	-24	-24	-20	-20	Adc
Gate Current—Pulsed	I_{GM}	± 1.5				Adc
Total Power Dissipation @ $T_C=25^\circ C$ Derate above $25^\circ C$	P_D	40 0.32				Watts W/ $^\circ C$
Operating and Storage Junction Temperature Range	T_J, T_{stg}	-55 to 150				$^\circ C$
Maximum Lead Temp. for Soldering Purposes, 1/8" from case for 5 seconds	T_L	300				$^\circ C$

- Notes:** (1) $T_J=25^\circ C$ to $150^\circ C$
(2) Pulse test: Pulse width $\leq 300\mu s$, Duty Cycle $\leq 2\%$
(3) Repetitive rating: Pulse width limited by max. junction temperature

ELECTRICAL CHARACTERISTICS ($T_C=25^\circ\text{C}$ unless otherwise specified)

Characteristic	Symbol	Type	Min	Typ	Max	Units	Test Conditions
Drain-Source Breakdown Voltage	BV_{DSS}	IRF9120/2 IRFP9120/2 IRF9520/2	-100	—	—	V	$V_{GS}=0V$
		IRF9121/3 IRFP9121/3 IRF9521/3	-60	—	—	V	$I_D=-250\mu A$
Gate Threshold Voltage	$V_{GS(th)}$	ALL	-2.0	—	-4.0	V	$V_{DS}=V_{GS}$, $I_D=-250\mu A$
Gate-Source Leakage Forward	I_{GSS}	ALL	—	—	-100	nA	$V_{GS}=-20V$
Gate-Source Leakage Reverse	I_{GSS}	ALL	—	—	100	nA	$V_{GS}=20V$
Zero Gate Voltage Drain Current	I_{DSS}	ALL	—	—	-250	μA	$V_{DS}=\text{Max. Rating}$, $V_{GS}=0V$
			—	—	-1000	μA	$V_{DS}=\text{Max. Rating}\times 0.8$, $V_{GS}=0V$, $T_C=125^\circ\text{C}$
On-State Drain-Source Current	$I_{D(on)}$	IRF9120/1 IRFP9120/1 IRF9520/1	-6.0	—	—	A	$V_{DS}>I_{D(on)}\times R_{DS(on)}$ max., $V_{GS}=-10V$
		IRF9122/3 IRFP9122/3 IRF9522/3	-5.0	—	—	A	
Static Drain-Source On-State Resistance (2)	$R_{DS(on)}$	IRF9120/1 IRFP9120/1 IRF9520/1	—	—	0.6	Ω	$V_{GS}=-10V$, $I_D=-3.5A$
		IRF9122/3 IRFP9122/3 IRF9522/3	—	—	0.8	Ω	
Forward Transconductance (2)	g_{fs}	ALL	0.9	—	—	Ω	$V_{DS}>I_{D(on)}\times R_{DS(on)}$ max., $I_D=-3.5A$
Input Capacitance	C_{iss}	ALL	—	—	450	pF	$V_{GS}=0V$, $V_{DS}=-25V$, $f=1.0\text{MHz}$
Output Capacitance	C_{oss}	ALL	—	—	350	pF	
Reverse Transfer Capacitance	C_{rss}	ALL	—	—	100	pF	
Turn-On Delay Time	$t_{d(on)}$	ALL	—	—	50	ns	
Rise Time	t_r	ALL	—	—	100	ns	$V_{DD}=0.5BV_{DSS}$, $I_D=-3.5A$, $Z_\theta=50\Omega$, (MOSFET switching times are essentially independent of operating temperature.)
Turn-Off Delay Time	$t_{d(off)}$	ALL	—	—	100	ns	
Fall Time	t_f	ALL	—	—	100	ns	
Total Gate Charge (Gate-Source Plus Gate-Drain)	Q_g	ALL	—	—	22	nC	$V_{GS}=-15V$, $I_D=-8.0A$, $V_{DS}=0.8$ Max. Rating (Gate charge is essentially independent of operating temperature.)
Gate-Source Charge	Q_{gs}	ALL	—	—	9	nC	
Gate-Drain ("Miller") Charge	Q_{gd}	ALL	—	—	13	nC	

THERMAL RESISTANCE

Junction-to-Case	R_{thJC}	ALL	—	—	3.12	K/W	
Case-to-Sink	R_{thCS}	ALL	—	1.0	—	K/W	Mounting surface flat, smooth, and greased
Junction-to-Ambient	R_{thJA}	IRFPXXXX	—	—	80	K/W	Free Air Operation
		IRF95XX	—	—	—	—	
		IRF91XX	—	—	30	K/W	

- Notes:** (1) $T_J=25^\circ\text{C}$ to 150°C
(2) Pulse test: Pulse width $\leq 300\mu s$, Duty Cycle $\leq 2\%$
(3) Repetitive rating: Pulse width limited by max. junction temperature

SOURCE-DRAIN DIODE RATINGS AND CHARACTERISTICS

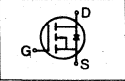
Characteristic	Symbol	Type	Min	Typ	Max	Units	Test Conditions
Continuous Source Current (Body Diode)	I_S	IRF9120/1 IRFP9120/1 IRF9520/1	—	—	-6.0	A	Modified MOSFET symbol showing the integral reverse P-N junction rectifier 
		IRF9122/3 IRFP9122/3 IRF9522/3	—	—	-5.0	A	
Pulse Source Current (Body Diode) (3)	I_{SM}	IRF9120/1 IRFP9120/1 IRF9520/1	—	—	-24	A	
		IRF9122/3 IRFP9122/3 IRF9522/3	—	—	-20	A	
Diode Forward Voltage (2)	V_{SD}	IRF9120/1 IRFP9120/1 IRF9520/1	—	—	-6.3	V	$T_C=25^\circ\text{C}$, $I_S=-6.0\text{A}$, $V_{GS}=0\text{V}$
		IRF9122/3 IRFP9122/3 IRF9522/3	—	—	-6.0	V	$T_C=25^\circ\text{C}$, $I_S=-5.0\text{A}$, $V_{GS}=0\text{V}$
Reverse Recovery Time	t_{rr}	ALL	—	—	—	ns	$T_J=150^\circ\text{C}$, $I_F=-6.0\text{A}$, $dI_F/dt=100\text{A}/\mu\text{s}$

Notes: (1) $T_J=25^\circ\text{C}$ to 150°C (2) Pulse test: Pulse width $\leq 300\mu\text{s}$, Duty Cycle $\leq 2\%$
(3) Repetitive rating: Pulse width limited by max. junction temperature

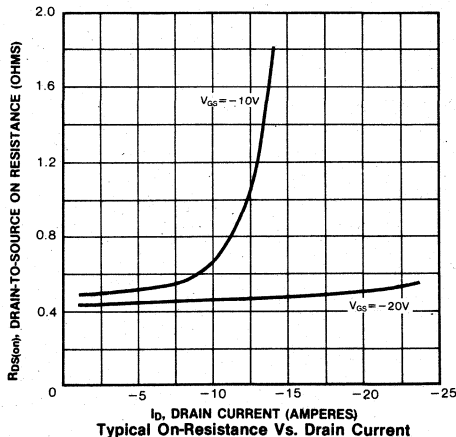
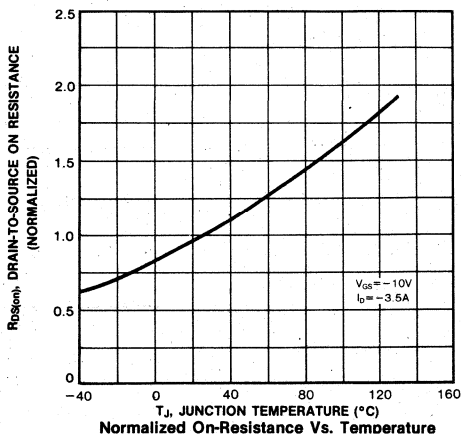
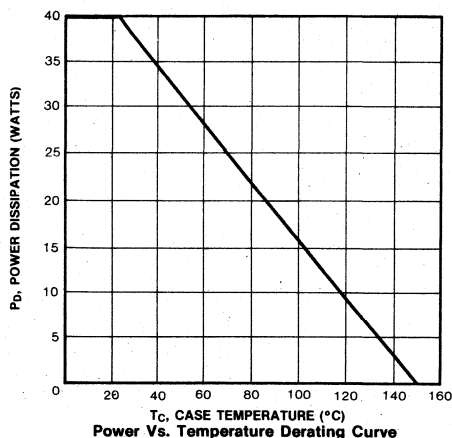
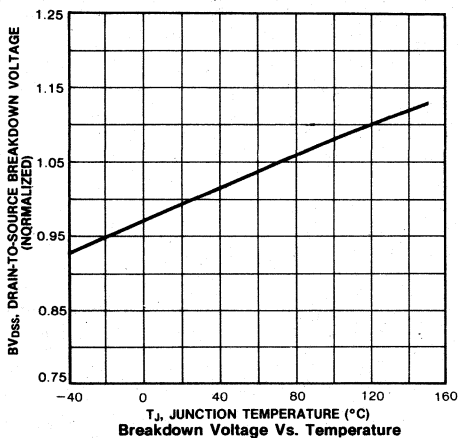

Preliminary Specifications

– 100 Volt, 0.30 Ohm SFET

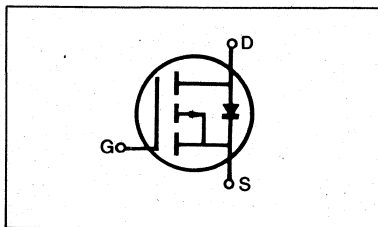

PRODUCT SUMMARY

Part Number	V _{DS}	R _{DS(on)}	I _D
IRF/IRFP9130, IRF9530	–100V	0.30Ω	–12A
IRF/IRFP9131, IRF9531	–60V	0.30Ω	–12A
IRF/IRFP9132, IRF9532	–100V	0.40Ω	–10A
IRF/IRFP9133, IRF9533	–60V	0.40Ω	–10A

FEATURES

- Low R_{DS(on)}
- Improved inductive ruggedness
- Fast switching times
- Rugged polysilicon gate cell structure
- Low input capacitance
- Extended safe operating area
- Improved high temperature reliability

PACKAGE STYLE

Package Type	Part Number
TO-3	IRF9130/9131/9132/9133
TO-3P	IRFP9130/9131/9132/9133
TO-220	IRF9530/9531/9532/9533

MAXIMUM RATINGS

Characteristic	Symbol	IRF/IRFP				Unit
		9130 9530	9131 9531	9132 9532	9133 9533	
Drain-Source Voltage (1)	V _{DSS}	–100	–60	–100	–60	Vdc
Drain-Gate Voltage (R _{GS} =1.0MΩ) (1)	V _{DGR}	–100	–60	–100	–60	Vdc
Gate-Source Voltage	V _{GS}	±20				Vdc
Continuous Drain Current T _C =25°C	I _D	–12	–12	–10	–10	Adc
Continuous Drain Current T _C =100°C	I _D	–7.5	–7.5	–6.5	–6.5	Adc
Drain Current—Pulsed (3)	I _{DM}	–48	–48	–40	–40	Adc
Gate Current—Pulsed	I _{GM}	±1.5				Adc
Total Power Dissipation @ T _C =25°C Derate above 25°C	P _D	75 0.6				Watts W/°C
Operating and Storage Junction Temperature Rangy	T _J , T _{stg}	–55 to 150				°C
Maximum Lead Temp. for Soldering Purposes, 1/8" from case for 5 seconds	T _L	300				°C

- Notes:** (1) T_J=25°C to 150°C
(2) Pulse test: Pulse width≤300μs, Duty Cycle≤2%
(3) Repetitive rating: Pulse width limited by max. junction temperature

ELECTRICAL CHARACTERISTICS ($T_C=25^\circ\text{C}$ unless otherwise specified)

Characteristic	Symbol	Type	Min	Typ	Max	Units	Test Conditions
Drain-Source Breakdown Voltage	BV_{DSS}	IRF9130/2 IRFP9130/2 IRF9530/2	-100	—	—	V	$V_{GS}=0V$
		IRF9131/3 IRFP9131/3 IRF9531/3	-60	—	—	V	$I_D=-250\mu A$
Gate Threshold Voltage	$V_{GS(th)}$	ALL	-2.0	—	-4.0	V	$V_{DS}=V_{GS}$, $I_D=-250\mu A$
Gate-Source Leakage Forward	I_{GSS}	ALL	—	—	-100	nA	$V_{GS}=-20V$
Gate-Source Leakage Reverse	I_{GSS}	ALL	—	—	100	nA	$V_{GS}=20V$
Zero Gate Voltage Drain Current	I_{DSS}	ALL	—	—	-250	μA	$V_{DS}=\text{Max. Rating}$, $V_{GS}=0V$
			—	—	-1000	μA	$V_{DS}=\text{Max. Rating}\times 0.8$, $V_{GS}=0V$, $T_C=125^\circ\text{C}$
On-State Drain-Source Current (2)	$I_{D(on)}$	IRF9130/1 IRFP9130/1 IRF9530/1	-12	—	—	A	$V_{DS}>I_{D(on)}\times R_{DS(on) \text{ max.}}$, $V_{GS}=-10V$
		IRF9132/3 IRFP9132/3 IRF9532/3	-10	—	—	A	
Static Drain-Source On-State Resistance (2)	$R_{DS(on)}$	IRF9130/2 IRFP9132/2 IRF9530/2	—	—	0.30	Ω	$V_{GS}=-10V$, $I_D=-6.5A$
		IRF9131/3 IRFP9131/3 IRF9531/3	—	—	0.40	Ω	
Forward Transconductance (2)	g_{fs}	ALL	2.0	—	—	S	$V_{DS}>I_{D(on)}\times R_{DS(on) \text{ max.}}$, $I_D=-6.5A$
Input Capacitance	C_{iss}	ALL	—	—	700	pF	$V_{GS}=0V$, $V_{DS}=-25V$, $f=1.0\text{MHz}$
Output Capacitance	C_{oss}	ALL	—	—	450	pF	
Reverse Transfer Capacitance	C_{rss}	ALL	—	—	200	pF	
Turn-On Delay Time	$t_{d(on)}$	ALL	—	—	60	ns	$V_{DD}=0.5BV_{DSS}$, $I_D=-6.5A$, $Z_\theta=50\Omega$ (MOSFET switching times are essentially independent of operating temperature.)
Rise Time	T_r	ALL	—	—	140	ns	
Turn-Off Delay Time	$t_{d(off)}$	ALL	—	—	140	ns	
Fall Time	t_f	ALL	—	—	140	ns	
Total Gate Charge (Gate-Source Plus Gate-Drain)	Q_g	ALL	—	—	45	nC	$V_{GS}=-15V$, $I_D=-15A$, $V_{DS}=0.8 \text{ Max. Rating}$ (Gate charge is essentially independent of operating temperature.)
Gate-Source Charge	Q_{gs}	ALL	—	—	20	nC	
Gate-Drain ("Miller") Charge	Q_{gd}	ALL	—	—	25	nC	

4

THERMAL RESISTANCE

Junction-to-Case	R_{thJC}	ALL	—	—	1.67	K/W	
Case-to-Sink	R_{thCS}	ALL	—	1.0	—	K/W	Mounting surface flat, smooth, and greased
Junction-to-Ambient	R_{thJA}	IRFPXXXX	—	—	80	K/W	Free Air Operation
		IRF95XX	—	—	—	—	
		IRF91XX	—	—	30	K/W	

- Notes:** (1) $T_J=25^\circ\text{C}$ to 150°C
(2) Pulse test: Pulse width $\leq 300\mu s$, Duty Cycle $\leq 2\%$
(3) Repetitive rating: Pulse width limited by max. junction temperature

SOURCE-DRAIN DIODE RATINGS AND CHARACTERISTICS

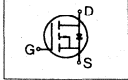
Characteristic	Symbol	Type	Min	Typ	Max	Units	Test Conditions
Continuous Source Current (Body Diode)	I_S	IRF9130/1 IRFP9130/1 IRF9530/1	—	—	-12	A	Modified MOSFET symbol showing the integral reverse P-N junction rectifier 
		IRF9132/3 IRFP9132/3 IRF9532/3	—	—	-10	A	
Pulse Source Current (Body Diode) (3)	I_{SM}	IRF9130/1 IRFP9130/1 IRF9530/1	—	—	-48	A	
		IRF9132/3 IRFP9132/3 IRF9532/3	—	—	-40	A	
Diode Forward Voltage (2)	V_{SD}	IRF9130/1 IRFP9130/1 IRF9530/1	—	—	-6.3	V	$T_C=25^\circ\text{C}$, $I_S=-12\text{A}$, $V_{GS}=0\text{V}$
		IRF9132/3 IRFP9132/3 IRF9532/3	—	—	-6.0	V	$T_C=25^\circ\text{C}$, $I_S=-10\text{A}$, $V_{GS}=0\text{V}$
Reverse Recovery Time	t_{rr}	ALL	—	—	—	ns	$T_J=150^\circ\text{C}$, $I_F=-12\text{A}$, $dI_F/dt=100\text{A}/\mu\text{s}$

Notes: (1) $T_J=25^\circ\text{C}$ to 150°C (2) Pulse test: Pulse width $\leq 300\mu\text{s}$, Duty Cycle $\leq 2\%$
 (3) Repetitive rating: Pulse width limited by max. junction temperature

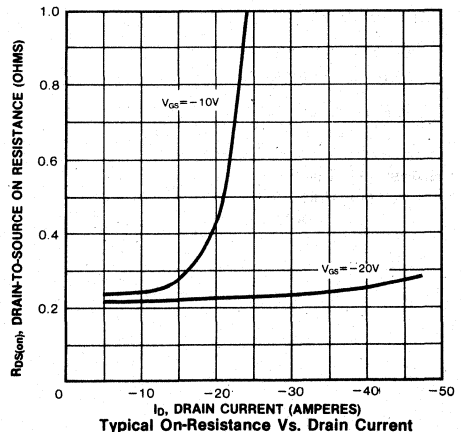
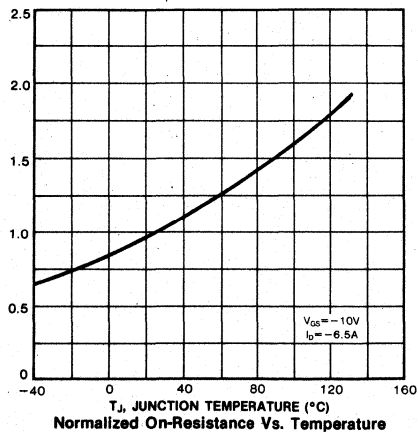
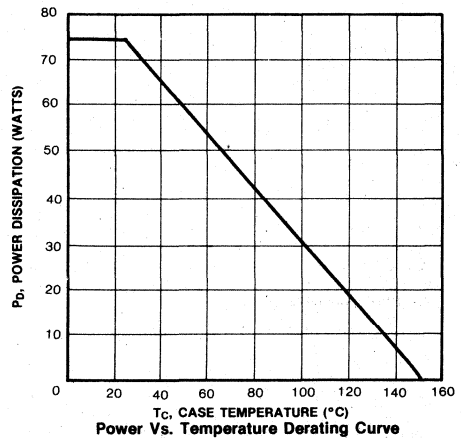
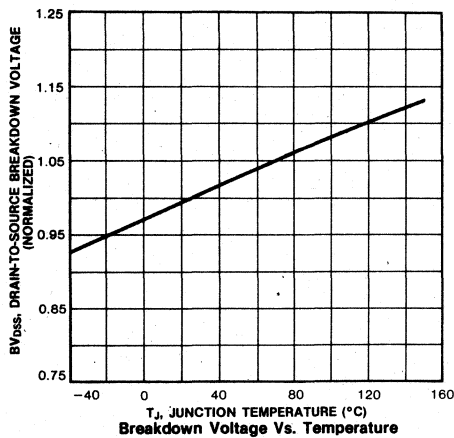

IRF9140/9141/9142/9143
IRFP9140/9141/9142/9143
IRF9540/9541/9542/9543

P-CHANNEL
POWER MOSFETS

Preliminary Specifications

– 100 Volt, 0.2 Ohm SFET

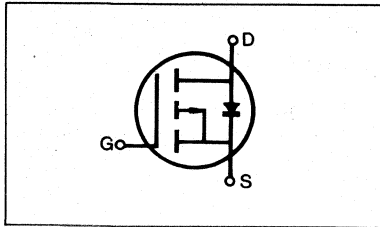

PRODUCT SUMMARY

Part Number	V _{DS}	R _{DS(on)}	I _D
IRF/IRFP9140, IRF9540	–100V	0.2Ω	–19A
IRF/IRFP9141, IRF9541	–60V	0.2Ω	–19A
IRF/IRFP9142, IRF9542	–100V	0.3Ω	–15A
IRF/IRFP9143, IRF9543	–60V	0.3Ω	–15A

FEATURES

- Low R_{DS(on)}
- Improved inductive ruggedness
- Fast switching times
- Rugged polysilicon gate cell structure
- Low input capacitance
- Extended safe operating area
- Improved high temperature reliability

PACKAGE STYLE

Package Type	Part Number
TO-3	IRF9140/9141/9142/9143
TO-3P	IRFP9140/9141/9142/9143
TO-220	IRF9540/9541/9542/9543

MAXIMUM RATINGS

Characteristic	Symbol	IRF/IRFP				Unit
		9140 9540	9141 9541	9142 9542	9143 9543	
Drain-Source Voltage (1)	V _{DSS}	–100	–60	–100	–60	V _{dc}
Drain-Gate Voltage (R _{GS} =1.0MΩ) (1)	V _{DGR}	–100	–60	–100	–60	V _{dc}
Gate-Source Voltage	V _{GS}	±20				V _{dc}
Continuous Drain Current T _C =25°C	I _D	–19	–19	–15	–15	A _{dc}
Continuous Drain Current T _C =100°C	I _D	–12	–12	–10	–10	A _{dc}
Drain Current—Pulsed (3)	I _{DM}	–76	–76	–60	–60	A _{dc}
Gate Current—Pulsed	I _{GM}	±1.5				A _{dc}
Total Power Dissipation @ T _C =25°C Derate above 25°C	P _D	125 1.0				Watts W/°C
Operating and Storage Junction Temperature Range	T _J , T _{stg}	–55 to 150				°C
Maximum Lead Temp. for Soldering Purposes, 1/8" from case for 5 seconds	T _L	300				°C

- Notes:** (1) T_J=25°C to 150°C
(2) Pulse test: Pulse width≤300μs, Duty Cycle≤2%
(3) Repetitive rating: Pulse width limited by max. junction temperature

ELECTRICAL CHARACTERISTICS ($T_C=25^\circ\text{C}$ unless otherwise specified)

Characteristic	Symbol	Type	Min	Typ	Max	Units	Test Conditions
Drain-Source Breakdown Voltage	BV_{DSS}	IRF9140/2 IRFP9140/2 IRF9540/2	-100	—	—	V	$V_{GS}=0V$
		IRF9141/3 IRFP9141/2 IRF9541/3	-60	—	—	V	$I_D=-250\mu A$
Gate Threshold Voltage	$V_{GS(th)}$	ALL	-2.0	—	-4.0	V	$V_{DS}=V_{GS}$, $I_D=-250\mu A$
Gate-Source Leakage Forward	I_{GSS}	ALL	—	—	-100	nA	$V_{GS}=-20V$
Gate-Source Leakage Reverse	I_{GSS}	ALL	—	—	100	nA	$V_{GS}=20V$
Zero Gate Voltage Drain Current	I_{DSS}	ALL	—	—	-250	μA	$V_{DS}=\text{Max. Rating}$, $V_{GS}=0V$
			—	—	-1000	μA	$V_{DS}=\text{Max. Rating} \times 0.8$, $V_{GS}=0V$, $T_C=125^\circ\text{C}$
On-State Drain-Source Current(2)	$I_{D(on)}$	IRF9140/1 IRFP9140/1 IRF9540/1	-19	—	—	A	$V_{DS}>I_{D(on)} \times R_{DS(on) \text{ max.}}$, $V_{GS}=-10V$
		IRF9142/3 IRFP9142/3 IRF9542/3	-15	—	—	A	
Static Drain-Source On-State Resistance (2)	$R_{DS(on)}$	IRF9140/1 IRFP9140/1 IRF9540/1	—	—	0.2	Ω	$V_{GS}=-10V$, $I_D=-10A$
		IRF9142/3 IRFP9142/3 IRF9542/3	—	—	0.3	Ω	
Forward Transconductance (2)	g_{fs}	ALL	5.0	—	—		$V_{DS}>I_{D(on)} \times R_{DS(on) \text{ max.}}$, $I_D=-10A$
Input Capacitance	C_{iss}	ALL	—	—	1300	pF	$V_{GS}=0V$, $V_{DS}=-25V$, $f=1.0\text{MHz}$
Output Capacitance	C_{oss}	ALL	—	—	700	pF	
Reverse Transfer Capacitance	C_{rss}	ALL	—	—	400	pF	
Turn-On Delay Time	$t_{d(on)}$	ALL	—	—	30	ns	$V_{DD}=0.5BV_{DSS}$, $I_D=-10A$, $Z_\theta=4.7\Omega$, (MOSFET switching times are essentially independent of operating temperature.)
Rise Time	t_r	ALL	—	—	15	ns	
Turn-Off Delay Time	$t_{d(off)}$	ALL	—	—	20	ns	
Fall Time	t_f	ALL	—	—	12	ns	
Total Gate Charge (Gate-Source Plus Gate-Drain)	Q_g	ALL	—	—	90	nC	$V_{GS}=-15V$, $I_D=-24A$, $V_{DS}=0.8 \text{ Max.}$ Rating (Gate charge is essentially independent of operating temperature.)
Gate-Source Charge	Q_{gs}	ALL	—	—	30	nC	
Gate-Drain ("Miller") Charge	Q_{gd}	ALL	—	—	60	nC	

THERMAL RESISTANCE

Junction-to-Case	R_{thJC}	ALL	—	—	1.0	K/W	
Case-to-Sink	R_{thCS}	ALL	—	0.1	—	K/W	Mounting surface flat, smooth, and greased
Junction-to-Ambient	R_{thJA}	IRFPXXXX IRF95XX	—	—	80	K/W	Free Air Operation
		IRF91XX	—	—	30	K/W	

- Notes:** (1) $T_J=25^\circ\text{C}$ to 150°C
(2) Pulse test: Pulse width $\leq 300\mu\text{s}$, Duty Cycle $\leq 2\%$
(3) Repetitive rating: Pulse width limited by max. junction temperature

SOURCE-DRAIN DIODE RATINGS AND CHARACTERISTICS

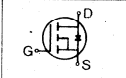
Characteristic	Symbol	Type	Min	Typ	Max	Units	Test Conditions
Continuous Source Current (Body Diode)	I_S	IRF9140/1 IRFP9140/1 IRF9540/1	—	—	-19	A	Modified MOSFET symbol showing the integral reverse P-N junction rectifier 
		IRF9142/3 IRFP9142/3 IRF9542/3	—	—	-15	A	
Pulse Source Current (Body Diode) (3)	I_{SM}	IRF9140/1 IRFP9140/1 IRF9540/1	—	—	-76	A	
		IRF9142/3 IRFP9142/3 IRF9542/3	—	—	-60	A	
Diode Forward Voltage (2)	V_{SD}	IRF9140/1 IRFP9140/1 IRF9540/1	—	—	-4.2	V	$T_C=25^\circ\text{C}$, $I_S=-19\text{A}$, $V_{GS}=0\text{V}$
		IRF9142/3 IRFP9142/3 IRF9542/3	—	—	-4.0	V	$T_C=25^\circ\text{C}$, $I_S=-15\text{A}$, $V_{GS}=0\text{V}$
Reverse Recovery Time	t_{rr}	ALL	—	—	—	ns	$T_J=150^\circ\text{C}$, $I_F=-19\text{A}$, $dI_F/dt=100\text{A}/\mu\text{s}$

Notes: (1) $T_J=25^\circ\text{C}$ to 150°C (2) Pulse test: Pulse width $\leq 300\mu\text{s}$, Duty Cycle $\leq 2\%$
 (3) Repetitive rating: Pulse width limited by max. junction temperature

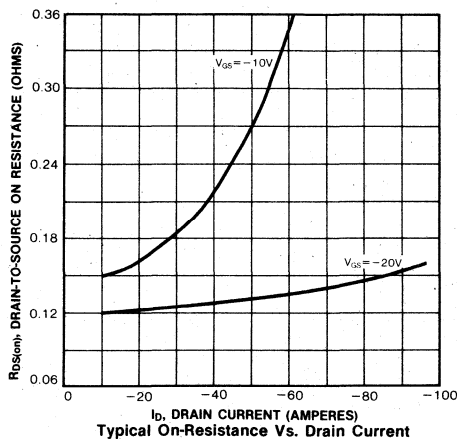
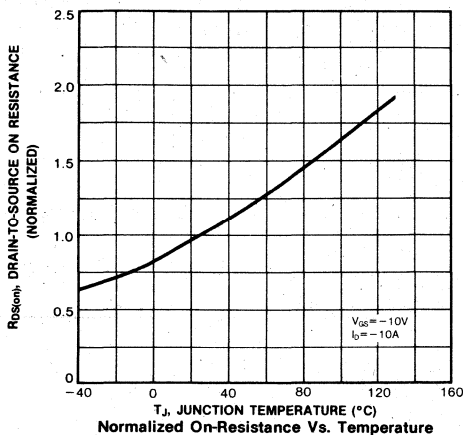
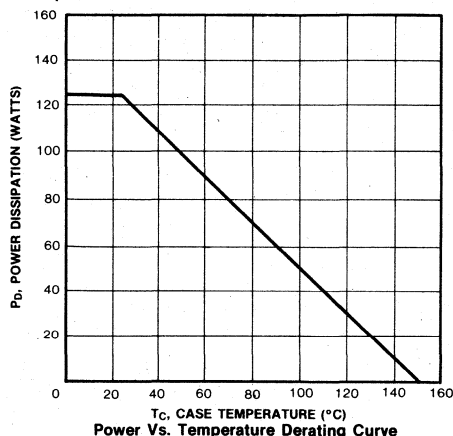
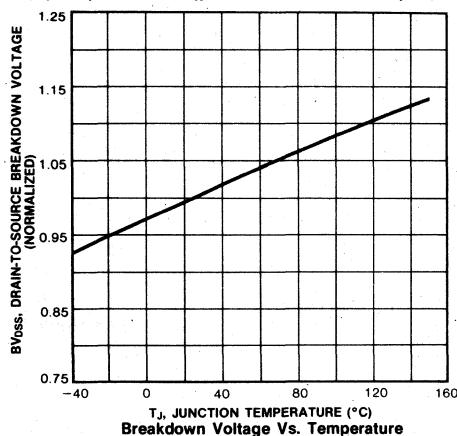

IRF9610/9611/9612/9613

P-CHANNEL POWER MOSFETS

Preliminary Specifications

- 200 Volt, 3.0 Ohm SFET

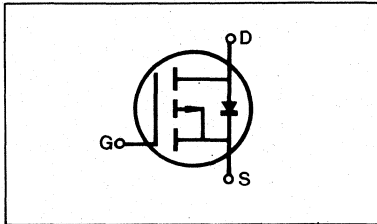

PRODUCT SUMMARY

Part Number	V _{DS}	R _{DS(on)}	I _D
IRF9610	-200V	3.0Ω	-1.75A
IRF9611	-150V	3.0Ω	-1.75A
IRF9612	-200V	4.5Ω	-1.5A
IRF9613	-150V	4.5Ω	-1.5A

FEATURES

- Low R_{DS(on)}
- Improved inductive ruggedness
- Fast switching times
- Rugged polysilicon gate cell structure
- Low input capacitance
- Extended safe operating area
- Improved high temperature reliability

PACKAGE STYLE

Package Type	Part Number
TO-220	IRF9610/9611/9612/9613

MAXIMUM RATINGS

Characteristic	Symbol	IRF				Unit
		9610	9611	9612	9613	
Drain-Source Voltage (1)	V _{DSS}	-200	-150	-200	-150	Vdc
Drain-Gate Voltage (R _{GS} =1.0MΩ)(1)	V _{DGR}	-200	-150	-200	-150	Vdc
Gate-Source Voltage	V _{GS}	±20				Vdc
Continuous Drain Current T _C =25°C	I _D	-1.75	-1.75	-1.5	-1.5	Adc
Continuous Drain Current T _C =100°C	I _D	-1.0	-1.0	-0.9	-0.9	Adc
Drain Current—Pulsed (3)	I _{DM}	-7.0	-7.0	-6.0	-6.0	Adc
Gate Current—Pulsed	I _{GM}	±1.5				Adc
Total Power Dissipation @ T _C =25°C Derate above 25°C	P _D	20 0.16				Watts W/°C
Operating and Storage Junction Temperature Range	T _J , T _{stg}	-55 to 150				°C
Maximum Lead Temp. for Soldering Purposes, 1/8" from case for 5 seconds	T _L	300				°C

- Notes: (1) T_J=25°C to 150°C
 (2) Pulse test: Pulse width ≤ 300μs, Duty Cycle ≤ 2%
 (3) Repetitive rating: Pulse width limited by max. junction temperature

ELECTRICAL CHARACTERISTICS ($T_C=25^\circ\text{C}$ unless otherwise specified)

Characteristic	Symbol	Type	Min	Typ	Max	Units	Test Conditions
Drain-Source Breakdown Voltage	BV_{DSS}	IRF9610 IRF9611	-200	—	—	V	$V_{GS}=0V$
		IRF9612 IRF9613	-150	—	—	V	$I_D=-250\mu A$
Gate Threshold Voltage	$V_{GS(th)}$	ALL	-2.0	—	-4.0	V	$V_{DS}=V_{GS}$, $I_D=-250\mu A$
Gate-Source Leakage Forward	I_{GSS}	ALL	—	—	-100	nA	$V_{GS}=-20V$
Gate-Source Leakage Reverse	I_{GSS}	ALL	—	—	100	nA	$V_{GS}=20V$
Zero Gate Voltage Drain Current	I_{DSS}	ALL	—	—	-250	μA	$V_{DS}=\text{Max. Rating}$, $V_{GS}=0V$
			—	—	-1000	μA	$V_{DS}=\text{Max. Rating}\times 0.8$, $V_{GS}=0V$, $T_C=125^\circ\text{C}$
On-State Drain-Source Current (2)	$I_{D(on)}$	IRF9610 IRF9611	-1.75	—	—	A	$V_{DS}>I_{D(on)}\times R_{DS(on) \text{ max.}}$, $V_{GS}=-10V$
		IRF9612 IRF9613	-1.5	—	—	A	
Static Drain-Source On-State Resistance (2)	$R_{DS(on)}$	IRF9610 IRF9611	—	—	3.0	Ω	$V_{GS}=-10V$, $I_D=-0.9A$
		IRF9612 IRF9613	—	—	4.5	Ω	
Forward Transconductance (2)	g_{fs}	ALL	0.9	—	—	S	$V_{DS}>I_{D(on)}\times R_{DS(on) \text{ max.}}$, $I_D=-0.9A$
Input Capacitance	C_{iss}	ALL	—	—	300	pF	$V_{GS}=0V$, $V_{DS}=-25V$, $f=1.0\text{MHz}$
Output Capacitance	C_{oss}	ALL	—	—	100	pF	
Reverse Transfer Capacitance	C_{rss}	ALL	—	—	35	pF	
Turn-On Delay Time	$t_{d(on)}$	ALL	—	—	15	ns	$V_{DD}=0.5BV_{DSS}$, $I_D=-1.5A$, $Z_\theta=505$ (MOSFET switching times are essentially independent of operating temperature.)
Rise Time	t_r	ALL	—	—	25	ns	
Turn-Off Delay Time	$t_{d(off)}$	ALL	—	—	15	ns	
Fall Time	t_f	ALL	—	—	15	ns	
Total Gate Charge (Gate-Source Plus Gate-Drain)	Q_g	ALL	—	—	11	nC	$V_{GS}=-15V$, $I_D=-3.5A$, $V_{DS}=0.8 \text{ Max.}$ Rating (Gate charge is essentially independent of operating temperature. See Fig. 8 page 21)
Gate-Source Charge	Q_{gs}	ALL	—	—	4	nC	
Gate-Drain ("Miller") Charge	Q_{gd}	ALL	—	—	7	nC	

THERMAL RESISTANCE

Junction-to-Case	R_{thJC}	ALL	—	—	6.4	K/W	
Case-to-Sink	R_{thCS}	ALL	—	1.0	—	K/W	Mounting surface flat, smooth, and greased
Junction-to-Ambient	R_{thJA}	ALL	—	—	80	K/W	Free Air Operation

- Notes:** (1) $T_J=25^\circ\text{C}$ to 150°C
 (2) Pulse test: Pulse width $\leq 300\mu\text{s}$, Duty Cycle $\leq 2\%$
 (3) Repetitive rating: Pulse width limited by max. junction temperature

SOURCE-DRAIN DIODE RATINGS AND CHARACTERISTICS

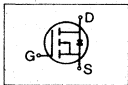
Characteristic	Symbol	Type	Min	Typ	Max	Units	Test Conditions
Continuous Source Current (Body Diode)	I_S	IRF9610	—	—	-1.75	A	Modified MOSFET symbol showing the integral reverse P-N junction rectifier 
		IRF9611	—	—	-1.5	A	
Pulse Source Current (Body Diode)(3)	I_{SM}	IRF9610	—	—	-7.0	A	
		IRF9611	—	—	-6.0	A	
Diode Forward Voltage (2)	V_{SD}	IRF9610	—	—	-5.8	V	$T_C=25^\circ\text{C}$, $I_S=-1.75\text{A}$, $V_{GS}=0\text{V}$
		IRF9611	—	—	-5.5	V	$T_C=25^\circ\text{C}$, $I_S=-1.5\text{A}$, $V_{GS}=0\text{V}$
Reverse Recovery Time	t_{rr}	ALL	—	—	—	ns	$T_J=150^\circ\text{C}$, $I_F=-1.75\text{A}$, $dI_F/dt=100\text{A}/\mu\text{s}$

Notes: (1) $T_J=25^\circ\text{C}$ to 150°C (2) Pulse test: Pulse width $\leq 300\mu\text{s}$, Duty Cycle $\leq 2\%$
 (3) Repetitive rating: Pulse width limited by max. junction temperature

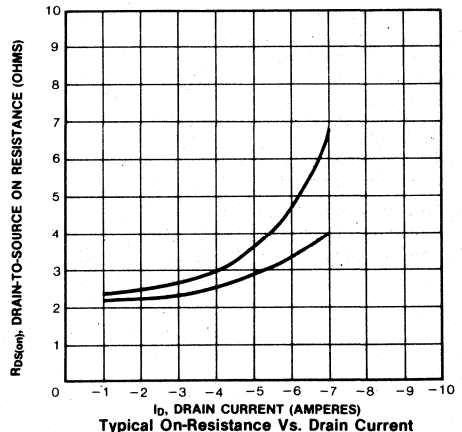
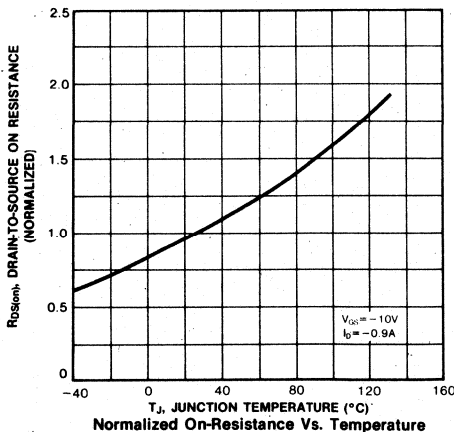
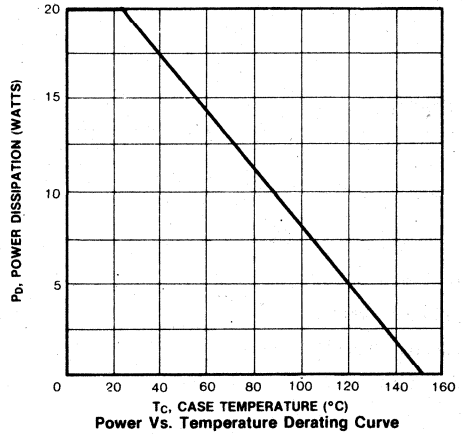
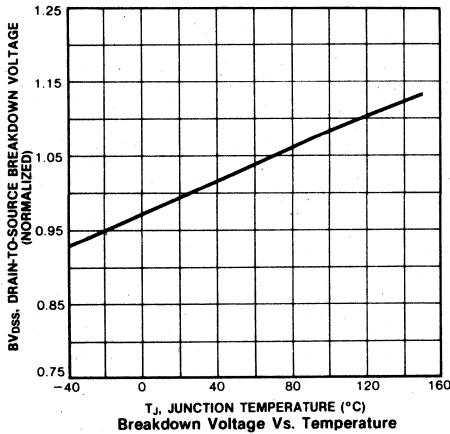

IRF9220/9221/9222/9223
IRFP9220/9221/9222/9223
IRF9620/9621/9622/9623

P-CHANNEL
POWER MOSFETS

Preliminary Specifications

- 200 Volt, 1.5 Ohm SFET

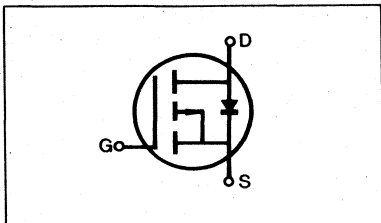

FEATURES

- Low $R_{DS(on)}$
- Improved inductive ruggedness
- Fast switching times
- Rugged polysilicon gate cell structure
- Low input capacitance
- Extended safe operating area
- Improved high temperature reliability

PRODUCT SUMMARY

Part Number	V_{DS}	$R_{DS(on)}$	I_D
IRF/IRFP9220, IRF9620	-200V	1.5 Ω	-3.5A
IRF/IRFP9221, IRF9621	-150V	1.5 Ω	-3.5A
IRF/IRFP9222, IRF9622	-200V	2.4 Ω	-3.0A
IRF/IRFP9223, IRF9623	-150V	2.4 Ω	-3.0A

PACKAGE STYLE

Package Type	Part Number
TO-3	IRF9220/9221/9222/9223
TO-3P	IRFP9220/9221/9222/9223
TO-220	IRF9620/9621/9622/9623

MAXIMUM RATINGS

Characteristic	Symbol	IRF/IRFP				Unit
		9220 9620	9221 9621	9222 9622	9223 9623	
Drain-Source Voltage (1)	V_{DSS}	-200	-150	-200	-150	Vdc
Drain-Gate Voltage ($R_{GS}=1.0M\Omega$) (1)	V_{DGR}	-200	-150	-200	-150	Vdc
Gate-Source Voltage	V_{GS}	± 20				Vdc
Continuous Drain Current $T_C=25^\circ C$	I_D	-3.5	-3.5	-3.0	-3.0	Adc
Continuous Drain Current $T_C=100^\circ C$	I_D	-2.0	-2.0	-1.5	-1.5	Adc
Drain Current—Pulsed (3)	I_{DM}	-14	-14	-12	-12	Adc
Gate Current—Pulsed	I_{GM}	± 1.5				Adc
Total Power Dissipation @ $T_C=25^\circ C$ Derate above $25^\circ C$	P_D	40 0.32				Watts W/ $^\circ C$
Operating and Storage Junction Temperature Range	T_J, T_{stg}	-55 to 150				$^\circ C$
Maximum Lead Temp. for Soldering Purposes, 1/8" from case for 5 seconds	T_L	300				$^\circ C$

- Notes:** (1) $T_J=25^\circ C$ to $150^\circ C$
(2) Pulse test: Pulse width $\leq 300\mu s$, Duty Cycle $\leq 2\%$
(3) Repetitive rating: Pulse width limited by max. junction temperature

ELECTRICAL CHARACTERISTICS ($T_C=25^\circ\text{C}$ unless otherwise specified)

Characteristic	Symbol	Type	Min	Typ	Max	Units	Test Conditions
Drain-Source Breakdown Voltage	BV _{DSS}	IRF9220/2 IRFP9220/2 IRF9620/2	-200	—	—	V	V _{GS} =0V
		IRF9221/3 IRFP9221/3 IRF9621/3	-150	—	—	V	I _D =-250μA
Gate Threshold Voltage	V _{GS(th)}	ALL	-2.0	—	-4.0	V	V _{DS} =V _{GS} , I _D =-250μA
Gate-Source Leakage Forward	I _{GSS}	ALL	—	—	-100	nA	V _{GS} =-20V
Gate-Source Leakage Reverse	I _{GSS}	ALL	—	—	100	nA	V _{GS} =20V
Zero Gate Voltage Drain Current	I _{DSS}	ALL	—	—	-250	μA	V _{DS} =Max. Rating, V _{GS} =0V
			—	—	-1000	μA	V _{DS} =Max. Rating×0.8, V _{GS} =0V, T _C =125°C
On-State Drain-Source Current (2)	I _{D(on)}	IRF9220/1 IRFP9220/1 IRF9620/1	-3.5	—	—	A	V _{DS} >I _{D(on)} ×R _{DS(on)} max., V _{GS} =-10V
		IRF9222/3 IRFP9222/3 IRF9622/3	-3.0	—	—	A	
Static Drain-Source On-State Resistance (2)	R _{DS(on)}	IRF9220/1 IRFP9220/1 IRF9620/1	—	—	1.5	Ω	V _{GS} =-10V, I _D =-1.5A
		IRF9222/3 IRFP9222/3 IRF9622/3	—	—	2.4	Ω	
Forward Transconductance (2)	g _{fs}	ALL	1.0	—	—	S	V _{DS} >I _{D(on)} ×R _{DS(on)} max., I _D =-1.5A
Input Capacitance	C _{iss}	ALL	—	—	400	pF	V _{GS} =0V, V _{DS} =-25V, f=1.0MHz
Output Capacitance	C _{oss}	ALL	—	—	125	pF	
Reverse Transfer Capacitance	C _{rss}	ALL	—	—	45	pF	
Turn-On Delay Time	t _{d(on)}	ALL	—	—	40	ns	V _{DD} =0.5BV _{DSS} , I _D =-1.5A, Z _θ =50Ω, (MOSFET switching times are essentially independent of operating temperature.)
Rise Time	t _r	ALL	—	—	50	ns	
Turn-Off Delay Time	t _{d(off)}	ALL	—	—	50	ns	
Fall Time	t _f	ALL	—	—	40	ns	
Total Gate Charge (Gate-Source Plus Gate-Drain)	Q _g	ALL	—	—	22	nC	V _{GS} =-15V, I _D =-4.0A, V _{DS} =0.8 Max. Rating (Gate charge is essentially independent of operating temperature.)
Gate-Source Charge	Q _{gs}	ALL	—	—	9	nC	
Gate-Drain ("Miller") Charge	Q _{gd}	ALL	—	—	13	nC	

THERMAL RESISTANCE

Junction-to-Case	R _{thJC}	ALL	—	—	3.12	K/W	
Case-to-Sink	R _{thCS}	ALL	—	1.0	—	K/W	Mounting surface flat, smooth, and greased
Junction-to-Ambient	R _{thJA}	IRFPXXXX IRF96XX	—	—	80	K/W	Free Air Operation
		IRF92XX	—	—	30	K/W	

- Notes:** (1) T_J=25°C to 150°C
(2) Pulse test: Pulse width≤300μs, Duty Cycle≤2%
(3) Repetitive rating: Pulse width limited by max. junction temperature

SOURCE-DRAIN DIODE RATINGS AND CHARACTERISTICS

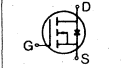
Characteristic	Symbol	Type	Min	Typ	Max	Units	Test Conditions
Continuous Source Current (Body Diode)	I _S	IRF9220/1 IRFP9220/1 IRF9620/1	—	—	-3.5	A	Modified MOSFET symbol showing the integral reverse P-N junction rectifier 
		IRF9232/3 IRFP9232/3 IRF9622/3	—	—	-3.0	A	
Pulse Source Current (Body Diode) (3)	I _{SM}	IRF9220/1 IRFP9220/1 IRF9620/1	—	—	-14	A	
		IRF9232/3 IRFP9232/3 IRF9622/3	—	—	-12	A	
		IRF9220/1 IRFP9220/1 IRF9620/1	—	—	-7.0	V	T _C =25°C, I _S =-3.5A, V _{GS} =0V
Diode Forward Voltage (2)	V _{SD}	IRF9220/1 IRFP9220/1 IRF9620/1	—	—	-7.0	V	T _C =25°C, I _S =-3.5A, V _{GS} =0V
		IRF9232/3 IRFP9232/3 IRF9622/3	—	—	-6.8	V	T _C =25°C, I _S =-3.0A, V _{GS} =0V
Reverse Recovery Time	t _{rr}	ALL	—	—	—	ns	T _J =150°C, I _F =-3.5A, dI _F /dt=100A/μs,

Notes: (1) T_J=25°C to 150°C (2) Pulse test: Pulse width<300μs, Duty Cycle≤2%
(3) Repetitive rating: Pulse width limited by max. junction temperature

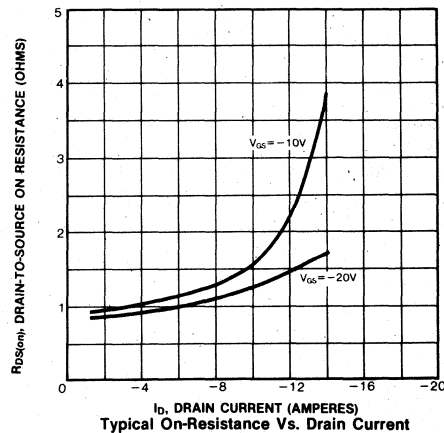
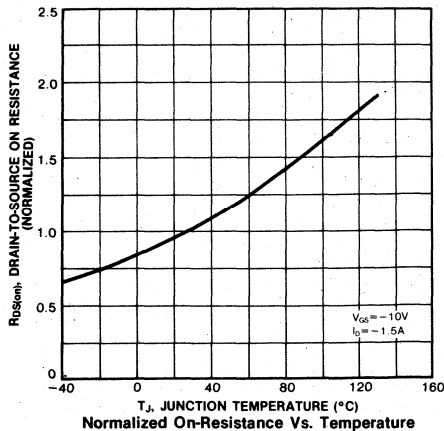
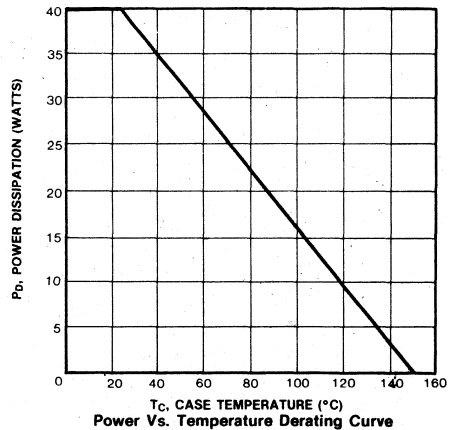
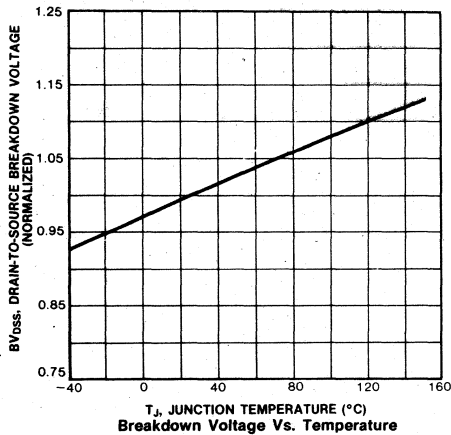

IRF9230/9231/9232/9233 IRFP9230/9231/9232/9233 IRF9630/9631/9632/9633

P-CHANNEL POWER MOSFETS

Preliminary Specifications

- 200 Volt, 0.8 Ohm SFET

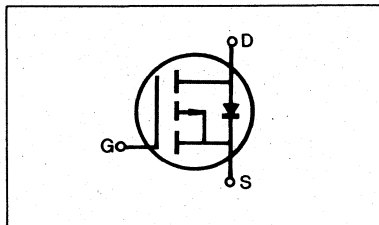

FEATURES

- Low $R_{DS(on)}$
- Improved inductive ruggedness
- Fast switching times
- Rugged polysilicon gate cell structure
- Low input capacitance
- Extended safe operating area
- Improved high temperature reliability

PRODUCT SUMMARY

Part Number	V_{DS}	$R_{DS(on)}$	I_D
IRF/IRFP9230, IRF9630	-200V	0.8 Ω	-6.5A
IRF/IRFP9231, IRF9631	-150V	0.8 Ω	-6.5A
IRF/IRFP9232, IRF9632	-200V	1.2 Ω	-5.5A
IRF/IRFP9233, IRF9633	-150V	1.2 Ω	-5.5A

PACKAGE STYLE

Package Type	Part Number
TO-3	IRF9230/9231/9232/9233
TO-3P	IRFP9230/9231/9232/9233
TO-220	IRF9630/9631/9632/9633

MAXIMUM RATINGS

Characteristic	Symbol	IRF/IRFP				Unit
		9230 9630	9231 9631	9232 9632	9233 9633	
Drain-Source Voltage (1)	V_{DSS}	-200	-150	-200	-150	Vdc
Drain-Gate Voltage ($R_{GS}=1.0M\Omega$) (1)	V_{DGR}	-200	-150	-200	-150	Vdc
Gate-Source Voltage	V_{GS}	± 20				Vdc
Continuous Drain Current $T_C=25^\circ C$	I_D	-6.5	-6.5	-5.5	-5.5	Adc
Continuous Drain Current $T_C=100^\circ C$	I_D	-4.0	-4.0	-3.5	-3.5	Adc
Drain Current—Pulsed (3)	I_{DM}	-26	-26	-22	-22	Adc
Gate Current—Pulsed	I_{GM}	± 1.5				Adc
Total Power Dissipation @ $T_C=25^\circ C$ Derate above $25^\circ C$	P_D	75 0.6				Watts W/ $^\circ C$
Operating and Storage Junction Temperature Rangy	T_J, T_{stg}	-55 to 150				$^\circ C$
Maximum Lead Temp. for Soldering Purposes, 1/8" from case for 5 seconds	T_L	300				$^\circ C$

- Notes: (1) $T_J=25^\circ C$ to $150^\circ C$
 (2) Pulse test: Pulse width $\leq 300\mu s$, Duty Cycle $\leq 2\%$
 (3) Repetitive rating: Pulse width limited by max. junction temperature

ELECTRICAL CHARACTERISTICS ($T_C=25^\circ\text{C}$ unless otherwise specified)

Characteristic	Symbol	Type	Min	Typ	Max	Units	Test Conditions
Drain-Source Breakdown Voltage	BV _{DSS}	IRF9230/2 IRFP9230/2 IRF9630/2	-200	—	—	V	V _{GS} =0V
		IRF9231/3 IRFP9231/3 IRF9631/3	-150	—	—	V	I _D = -250μA
Gate Threshold Voltage	V _{GS(th)}	ALL	-2.0	—	-4.0	V	V _{DS} = V _{GS} , I _D = -250μA
Gate-Source Leakage Forward	I _{GSS}	ALL	—	—	-100	nA	V _{GS} = -20V
Gate-Source Leakage Reverse	I _{GSS}	ALL	—	—	100	nA	V _{GS} = 20V
Zero Gate Voltage Drain Current	I _{DSS}	ALL	—	—	-250	μA	V _{DS} = Max. Rating, V _{GS} = 0V
			—	—	-1000	μA	V _{DS} = Max. Rating × 0.8, V _{GS} = 0V, T _C = 125°C
On-State Drain-Source Current (2)	I _{D(on)}	IRF9230/1 IRFP9230/1 IRF9630/1	-6.5	—	—	A	V _{DS} > I _{D(on)} × R _{DS(on) max.} , V _{GS} = -10V
		IRF9232/3 IRFP9232/3 IRF9632/3	-5.5	—	—	A	
Static Drain-Source On-State Resistance (2)	R _{DS(on)}	IRF9230/1 IRFP9230/1 IRF9630/1	—	—	0.8	Ω	V _{GS} = -10V, I _D = -3.5A
		IRF9232/3 IRFP9232/3 IRF9632/3	—	—	1.2	Ω	
Forward Transconductance (2)	g _{fs}	ALL	2.2	—	—	Ω	V _{DS} > I _{D(on)} × R _{DS(on) max.} , I _D = -3.5A
Input Capacitance	C _{iss}	ALL	—	—	650	pF	V _{GS} = 0V, V _{DS} = -25V, f = 1.0MHz
Output Capacitance	C _{oss}	ALL	—	—	300	pF	
Reverse Transfer Capacitance	C _{rss}	ALL	—	—	90	pF	
Turn-On Delay Time	t _{d(on)}	ALL	—	—	50	ns	V _{DD} = 0.5BV _{DSS} , I _D = -3.5A, Z _θ = 50Ω, (MOSFET switching times are essentially independent of operating temperature.)
Rise Time	t _r	ALL	—	—	100	ns	
Turn-Off Delay Time	t _{d(off)}	ALL	—	—	100	ns	
Fall Time	t _f	ALL	—	—	80	ns	
Total Gate Charge (Gate-Source Plus Gate-Drain)	Q _g	ALL	—	—	45	nC	V _{GS} = -15V, I _D = -8.0A, V _{DS} = 0.8 Max. Rating (Gate charge is essentially independent of operating temperature.)
Gate-Source Charge	Q _{gs}	ALL	—	—	20	nC	
Gate-Drain ("Miller") Charge	Q _{gd}	ALL	—	—	25	nC	

THERMAL RESISTANCE

Junction-to-Case	R _{thJC}	ALL	—	—	1.67	K/W	
Case-to-Sink	R _{thCS}	ALL	—	1.0	—	K/W	Mounting surface flat, smooth, and greased
Junction-to-Ambient	R _{thJA}	IRFPXXXX	—	—	80	K/W	Free Air Operation
		IRF96XX	—	—	80	K/W	
		IRF92XX	—	—	30	K/W	

- Notes:** (1) T_J = 25°C to 150°C
(2) Pulse test: Pulse width ≤ 300μs, Duty Cycle ≤ 2%
(3) Repetitive rating: Pulse width limited by max. junction temperature

SOURCE-DRAIN DIODE RATINGS AND CHARACTERISTICS

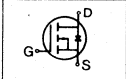
Characteristic	Symbol	Type	Min	Typ	Max	Units	Test Conditions
Continuous Source Current (Body Diode)	I_S	IRF9230/1 IRFP9230/1 IRF9630/1	—	—	-6.5	A	Modified MOSFET symbol showing the integral reverse P-N junction rectifier 
		IRF9232/3 IRFP9232/3 IRF9632/3	—	—	-5.5	A	
Pulse Source Current (Body Diode) (3)	I_{SM}	IRF9230/1 IRFP9230/1 IRF9630/1	—	—	-26	A	
		IRF9232/3 IRFP9232/3 IRF9632/3	—	—	-22	A	
Diode Forward Voltage (2)	V_{SD}	IRF9230/1 IRFP9230/1 IRF9630/1	—	—	-6.5	V	$T_C=25^\circ\text{C}$, $I_S=-6.5\text{A}$, $V_{GS}=0\text{V}$
		IRF9232/3 IRFP9232/3 IRF9632/3	—	—	-6.3	V	$T_C=25^\circ\text{C}$, $I_S=-5.5\text{A}$, $V_{GS}=0\text{V}$
Reverse Recovery Time	t_{rr}	ALL	—	—	—	ns	$T_J=150^\circ\text{C}$, $I_F=-6.5\text{A}$, $dI_F/dt=100\text{A}/\mu\text{s}$

Notes: (1) $T_J=25^\circ\text{C}$ to 150°C (2) Pulse test: Pulse width $\leq 300\mu\text{s}$, Duty Cycle $\leq 2\%$
 (3) Repetitive rating: Pulse width limited by max. junction temperature

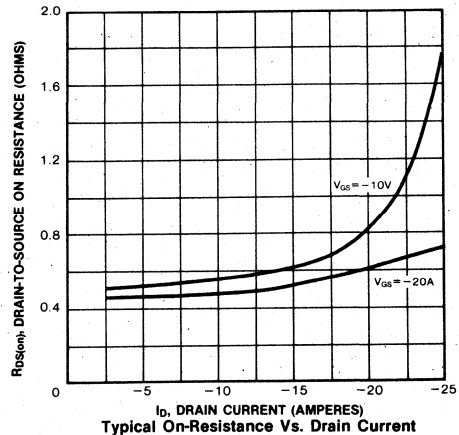
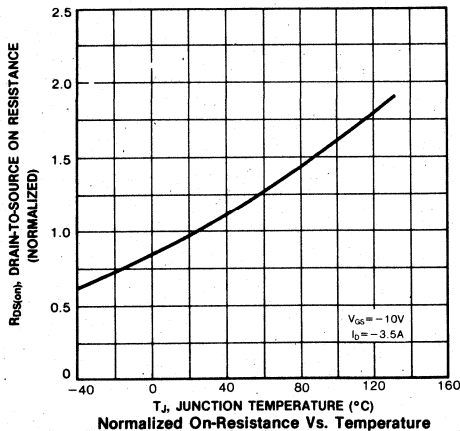
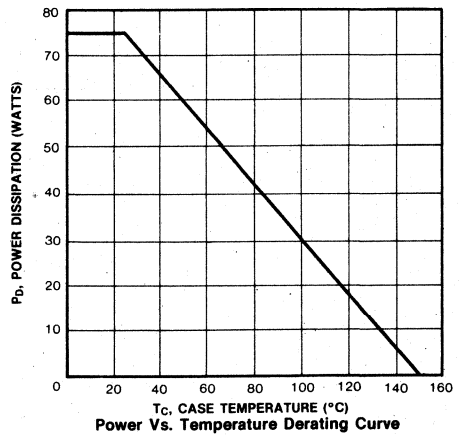
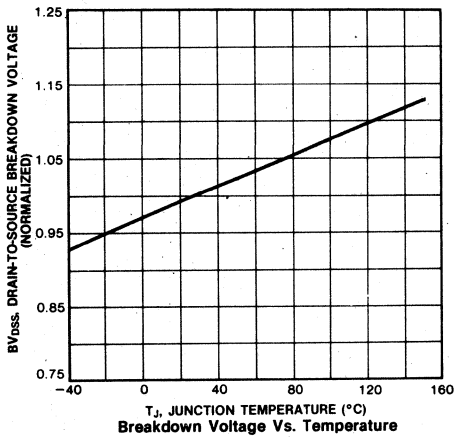

Preliminary Specifications

- 200 Volt, 0.5 Ohm SFET

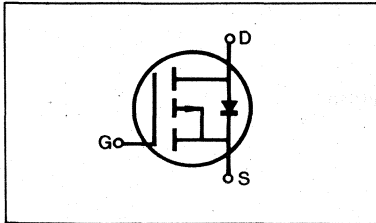

FEATURES

- Low $R_{DS(on)}$
- Improved inductive ruggedness
- Fast switching times
- Rugged polysilicon gate cell structure
- Low input capacitance
- Extended safe operating area
- Improved high temperature reliability

PRODUCT SUMMARY

Part Number	V_{DS}	$R_{DS(on)}$	I_D
IRF/IRFP9240, IRF9640	-200V	0.5 Ω	-11A
IRF/IRFP9241, IRF9641	-150V	0.5 Ω	-11A
IRF/IRFP9242, IRF9642	-200V	0.7 Ω	-9.0A
IRF/IRFP9243, IRF9643	-150V	0.7 Ω	-9.0A

PACKAGE STYLE

Package Type	Part Number
TO-3	IRF9240/9241/9242/9243
TO-3P	IRFP9240/9241/9242/9243
TO-220	IRF9640/9641/9642/9643

MAXIMUM RATINGS

Characteristic	Symbol	IRF/IRFP				Unit
		9240 9640	9241 9641	9242 9642	9243 9643	
Drain-Source Voltage (1)	V_{DS}	-200	-150	-200	-150	Vdc
Drain-Gate Voltage ($R_{GS}=1.0M\Omega$) (1)	V_{DGR}	-200	-150	-200	-150	vac
Gate-Source Voltage	V_{GS}	± 20				Vdc
Continuous Drain Current $T_C=25^\circ C$	I_D	-11	-11	-9.0	-9.0	Adc
Continuous Drain Current $T_C=100^\circ C$	I_D	-7.0	-7.0	-6.0	-6.0	Adc
Drain Current—Pulsed (3)	I_{DM}	-44	-44	-36	-36	Adc
Gate Current—Pulsed	I_{GM}	± 1.5				Adc
Total Power Dissipation @ $T_C=25^\circ C$ Derate above $25^\circ C$	P_D	125 1.0				Watts W/ $^\circ C$
Operating and Storage Junction Temperature Rangy	T_J, T_{stg}	-55 to 150				$^\circ C$
Maximum Lead Temp. for Soldering Purposes, 1/8" from case for 5 seconds	T_L	300				$^\circ C$

- Notes:** (1) $T_J=25^\circ C$ to $150^\circ C$
(2) Pulse test: Pulse width $\leq 300\mu s$, Duty Cycle $\leq 2\%$
(3) Repetitive rating: Pulse width limited by max. junction temperature

4

ELECTRICAL CHARACTERISTICS ($T_C=25^\circ\text{C}$ unless otherwise specified)

Characteristic	Symbol	Type	Min	Typ	Max	Units	Test Conditions
Drain-Source Breakdown Voltage	BV _{DSS}	IRF9240/2 IRFP9240/2 IRF9640/2	-200	—	—	V	V _{GS} =0V
		IRF9241/3 IRFP9241/3 IRF9641/3	-150	—	—	V	I _D =-250μA
Gate Threshold Voltage	V _{GS(th)}	ALL	-2.0	—	-4.0	V	V _{DS} =V _{GS} , I _D =-250μA
Gate-Source Leakage Forward	I _{GSS}	ALL	—	—	-100	nA	V _{GS} =-20V
Gate-Source Leakage Reverse	I _{GSS}	ALL	—	—	100	nA	V _{GS} =20V
Zero Gate Voltage Drain Current	I _{DSS}	ALL	—	—	-250	μA	V _{DS} =Max. Rating, V _{GS} =0V
			—	—	-1000	μA	V _{DS} =Max. Rating×0.8, V _{GS} =0V, T _C =125°C
On-State Drain-Source Current (2)	I _{D(on)}	IRF9240/1 IRFP9240/1 IRF9640/1	-11	—	—	A	V _{DS} >I _{D(on)} ×R _{DS(on)} max., V _{GS} =-10V
		IRF9642 IRF9643	-9.0	—	—	A	
Static Drain-Source On-State Resistance (2)	R _{DS(on)}	IRF9240/1 IRFP9240/1 IRF9640/1	—	—	0.5	Ω	V _{GS} =-10V, I _D =-6.0A
		IRF9242/3 IRFP9242/3 IRF9642/3	—	—	0.7	Ω	
Forward Transconductance (2)	g _{fs}	ALL	4.0	—	—	Ω	V _{DS} >I _{D(on)} ×R _{DS(on)} max., I _D =-6.0A
Input Capacitance	C _{iss}	ALL	—	—	1300	pF	V _{GS} =0V, V _{DS} =-25V, f=1.0MHz
Output Capacitance	C _{oss}	ALL	—	—	450	pF	
Reverse Transfer Capacitance	C _{rss}	ALL	—	—	250	pF	
Turn-On Delay Time	t _{d(on)}	ALL	—	—	30	ns	V _{DD} =0.5BV _{DSS} , I _D =-6.0A, Z _O =4.7Ω, (MOSFET switching times are essentially independent of operating temperature.)
Rise Time	t _r	ALL	—	—	15	ns	
Turn-Off Delay Time	t _{d(off)}	ALL	—	—	18	ns	
Fall Time	t _f	ALL	—	—	12	ns	
Total Gate Charge (Gate-Source Plus Gate-Drain)	Q _g	ALL	—	—	90	nC	V _{GS} =-15V, I _D =-22A, V _{DS} =0.8 Max. Rating (Gate charge is essentially independent of operating temperature.)
Gate-Source Charge	Q _{gs}	ALL	—	—	30	nC	
Gate-Drain ("Miller") Charge	Q _{gd}	ALL	—	—	60	nC	

THERMAL RESISTANCE

Junction-to-Case	R _{thJC}	ALL	—	—	1.0	K/W	
Case-to-Sink	R _{thCS}	ALL	—	1.0	—	K/W	Mounting surface flat, smooth, and greased
Junction-to-Ambient	R _{thJA}	IRFPXXXX	—	—	80	K/W	Free Air Operation
		IRF96XX	—	—	—	—	
		IRF92XX	—	—	30	K/W	

- Notes:** (1) T_J=25°C to 150°C
(2) Pulse test: Pulse width≤300μs, Duty Cycle≤2%
(3) Repetitive rating: Pulse width limited by max. junction temperature

SOURCE-DRAIN DIODE RATINGS AND CHARACTERISTICS

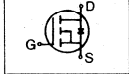
Characteristic	Symbol	Type	Min	Typ	Max	Units	Test Conditions
Continuous Source Current (Body Diode)	I _S	IRF9240/1 IRFP9240/1 IRF9640/1	—	—	-11	A	Modified MOSFET symbol showing the integral reverse P-N junction rectifier 
		IRF9242/3 IRFP9242/3 IRF9642/3	—	—	-9.0	A	
		IRF9240/1 IRFP9240/1 IRF9640/1	—	—	-44	A	
Pulse Source Current (Body Diode) (3)	I _{SM}	IRF9240/1 IRFP9240/1 IRF9640/1	—	—	-44	A	
		IRF9242/3 IRFP9242/3 IRF9642/3	—	—	-36	A	
		IRF9240/1 IRFP9240/1 IRF9640/1	—	—	-4.6	V	
Diode Forward Voltage (2)	V _{SD}	IRF9242/3 IRFP9242/3 IRF9642/3	—	—	-4.4	V	T _C =25°C, I _S =-9.0A, V _{GS} =0V
		IRF9240/1 IRFP9240/1 IRF9640/1	—	—	—	ns	T _J =150°C, I _F =-11A, dI _F /dt=100A/μs
		IRF9242/3 IRFP9242/3 IRF9642/3	—	—	—	ns	

Notes: (1) T_J=25°C to 150°C (2) Pulse test: Pulse width ≤ 300μs, Duty Cycle ≤ 2%
 (3) Repetitive rating: Pulse width limited by max. junction temperature

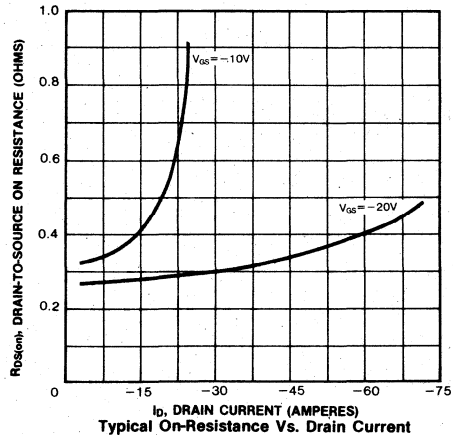
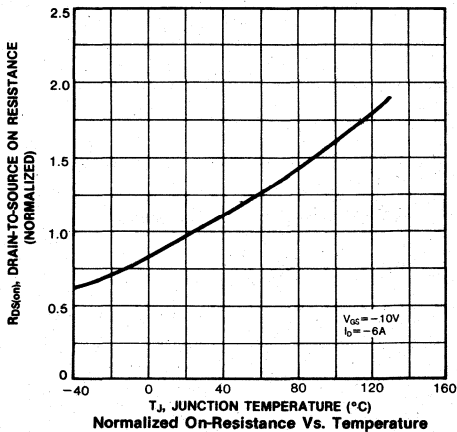
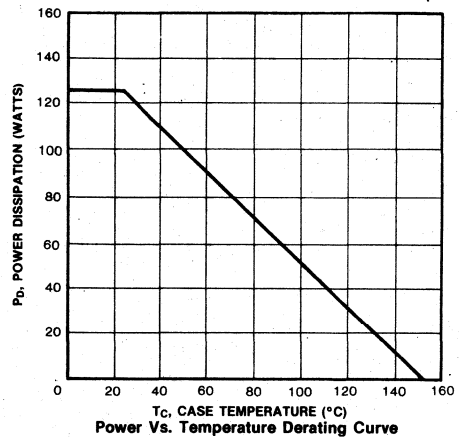
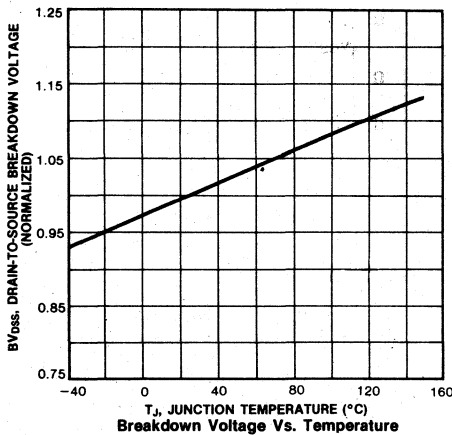

NOTES

A large, empty rectangular box with a thin black border, occupying most of the page below the 'NOTES' header. It is intended for handwritten notes.



TEST CIRCUITS 5

TEST CIRCUITS

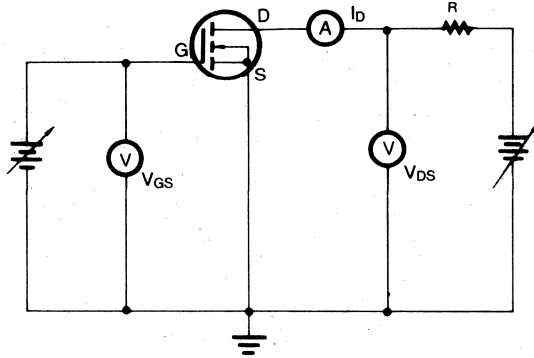

Fig. 1. Test Circuit for Breakdown Voltage (BV_{DSS}) and Drain-Source Current (I_{DSS})

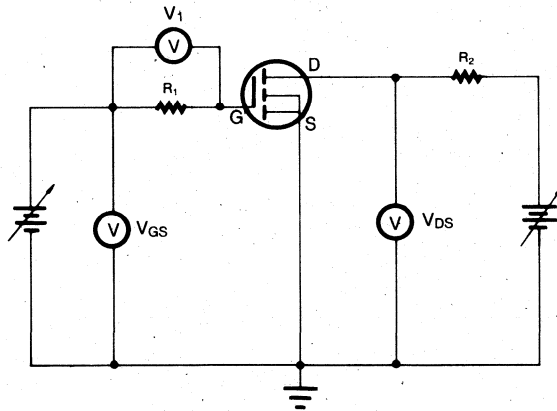

Fig. 2. Test Circuit for Gate-Source Leakage Current (I_{GSS})

TEST CIRCUITS

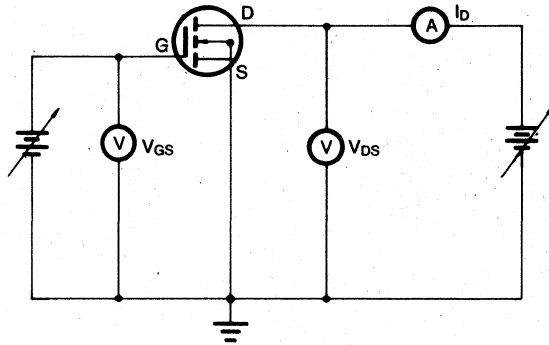

Fig. 3. Test Circuit for Drain-Source on-Resistance ($R_{DS(on)}$)

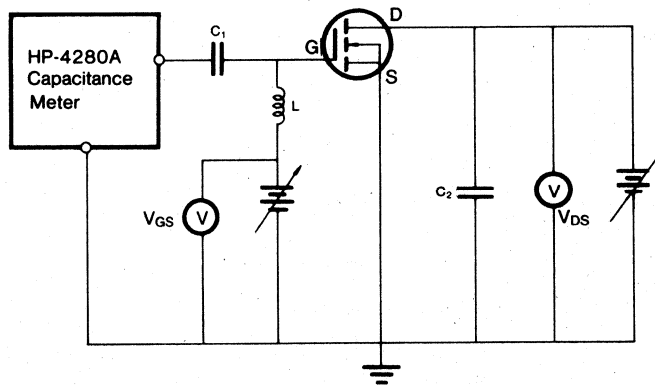

Fig. 4. C_{iss} Test Circuit

TEST CIRCUITS

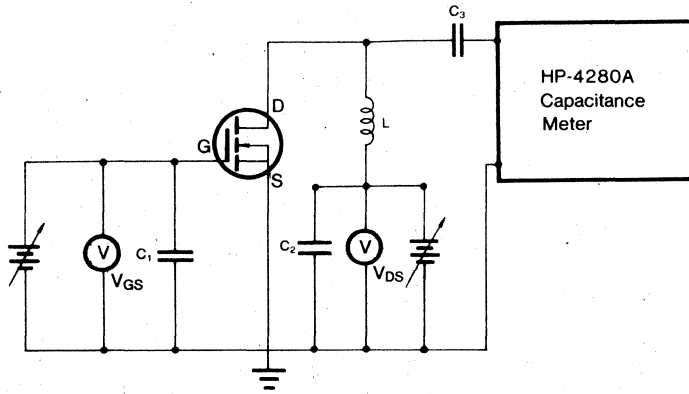

Fig. 5. C_{oss} Test Circuit

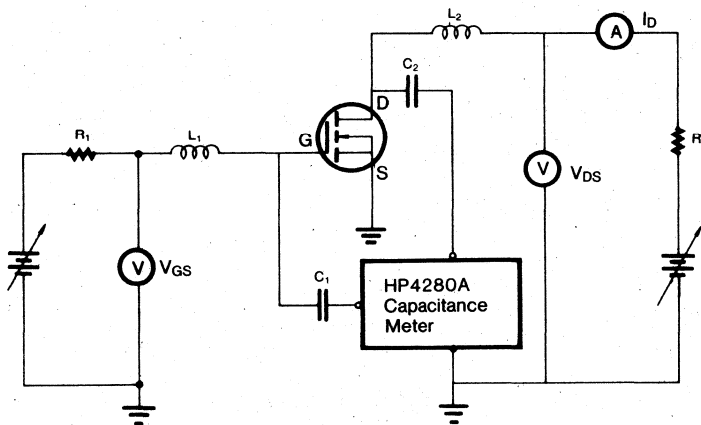

Fig. 6. C_{rss} Test Circuit

5

TEST CIRCUITS

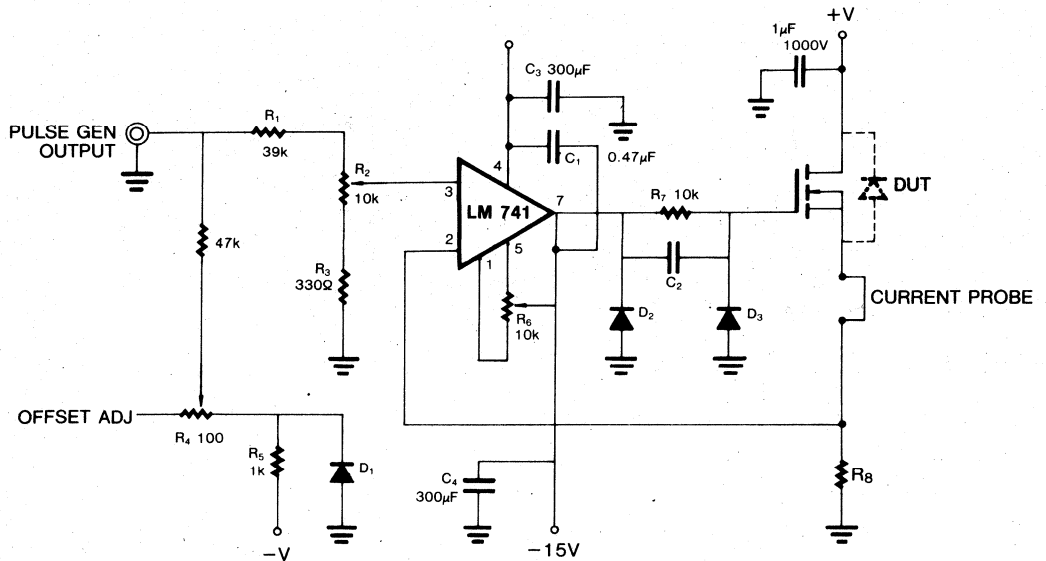

Fig. 7. Safe Operating Area Test Circuit (SOA)

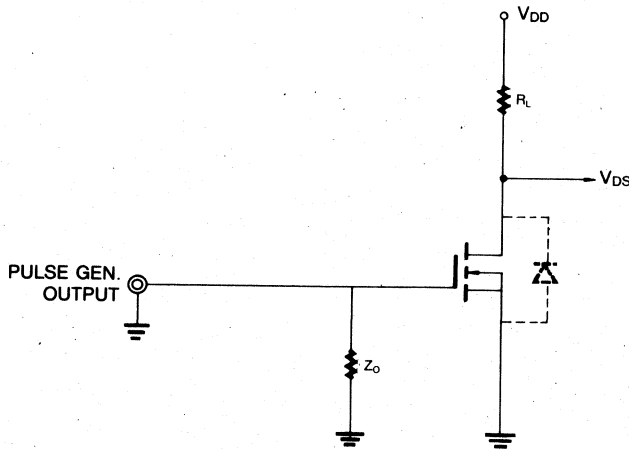

Fig. 8. Switching Time Test Circuit

TEST CIRCUITS

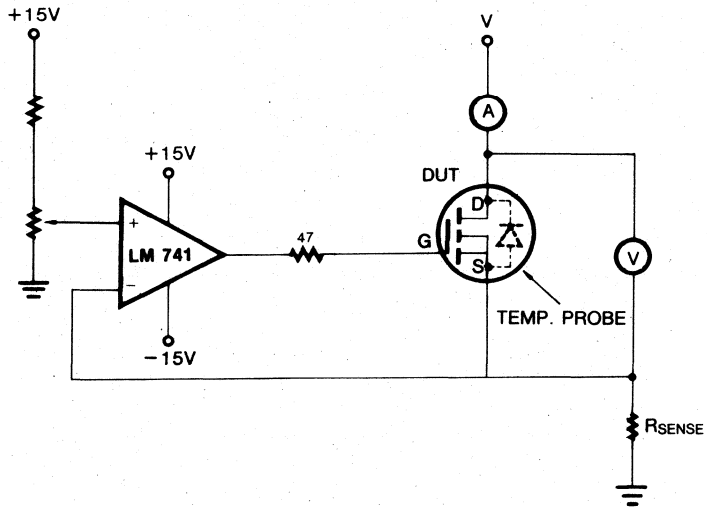

Fig. 9. R_{thJA} Test Circuit

5

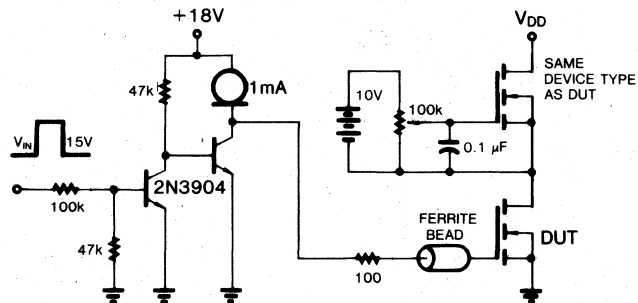

Fig. 10. Gate Charge Test Circuit.

TEST CIRCUITS

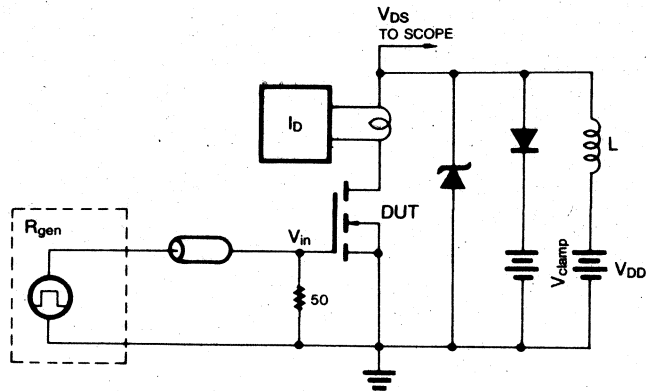

Fig. 11. Clamped Inductive Test Circuit

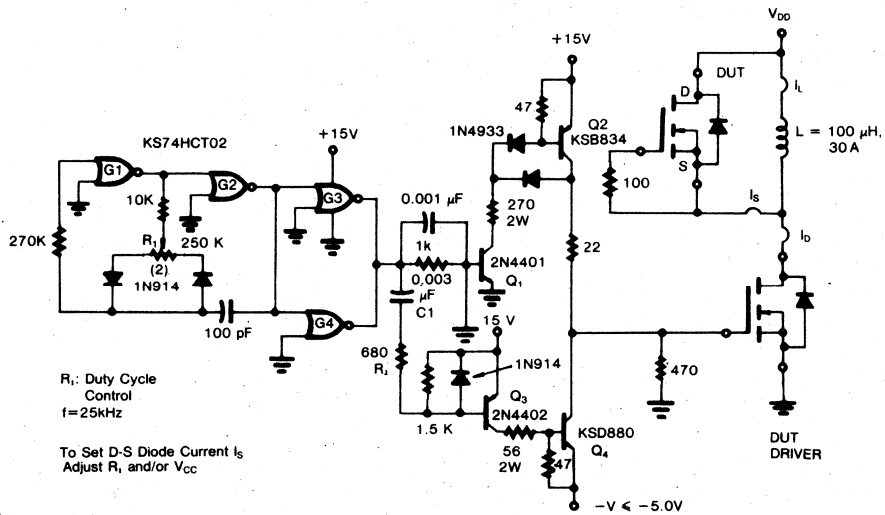

Fig. 12. T_{rr} Test Circuit

A black and white photograph of a control room. Two operators are seated at a large console filled with various instruments, dials, and control panels. The room has a grid-like ceiling with recessed lighting. The overall atmosphere is technical and professional.

PACKAGE DIMENSIONS 6

101

PACKAGE DIMENSIONS

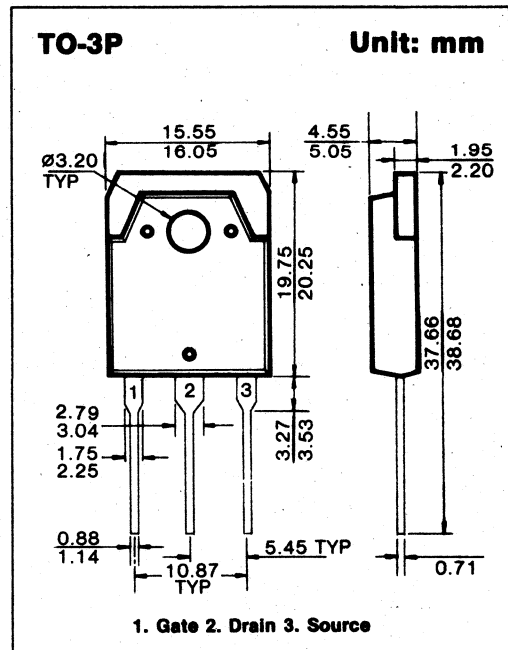
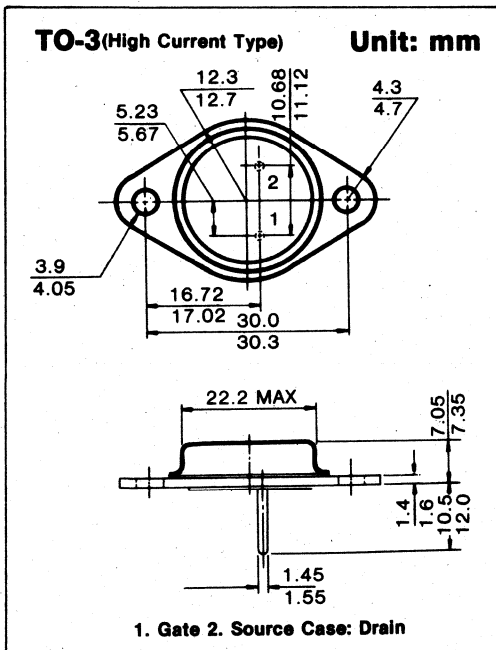
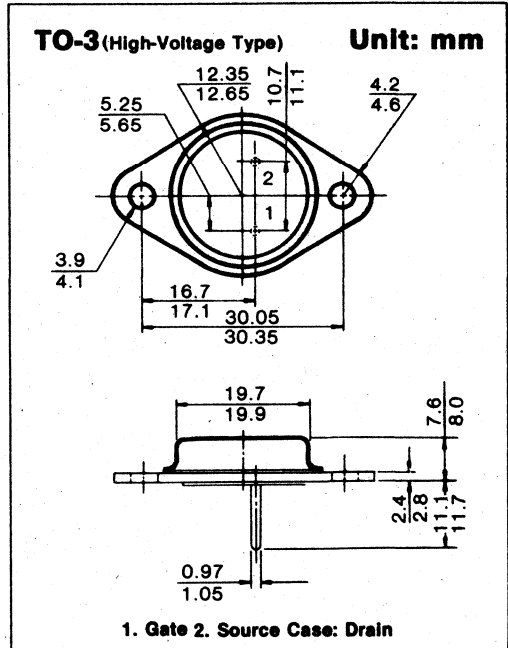
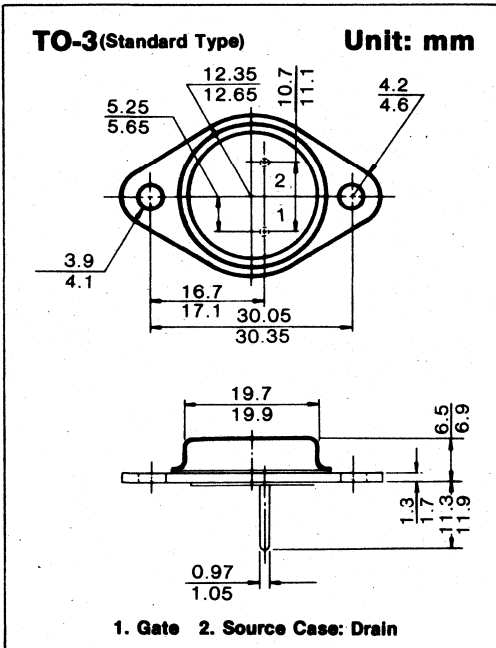

6

PACKAGE DIMENSIONS

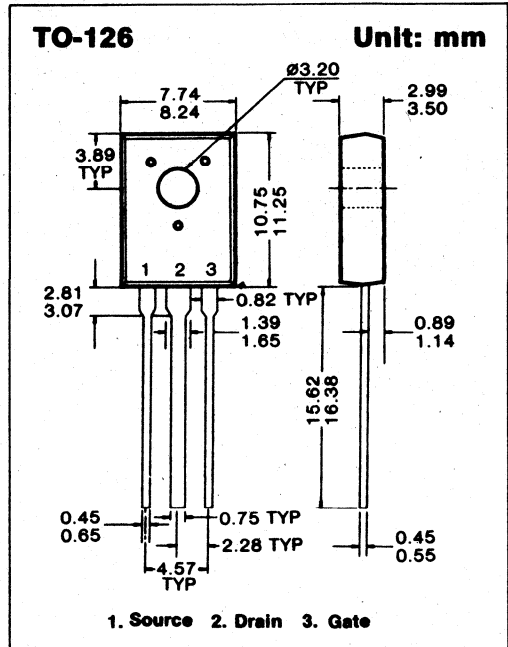
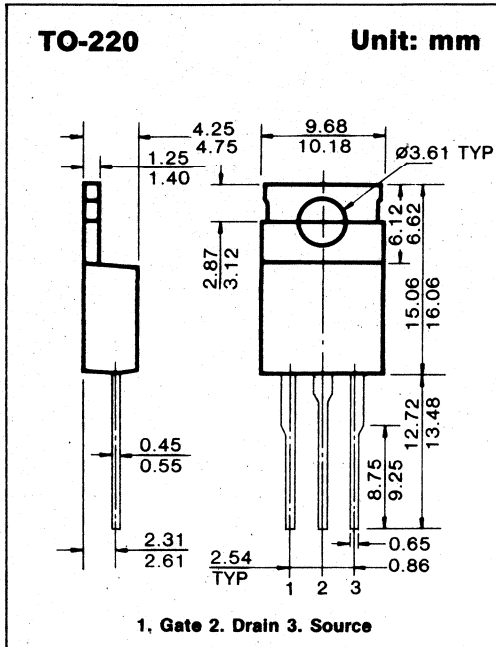

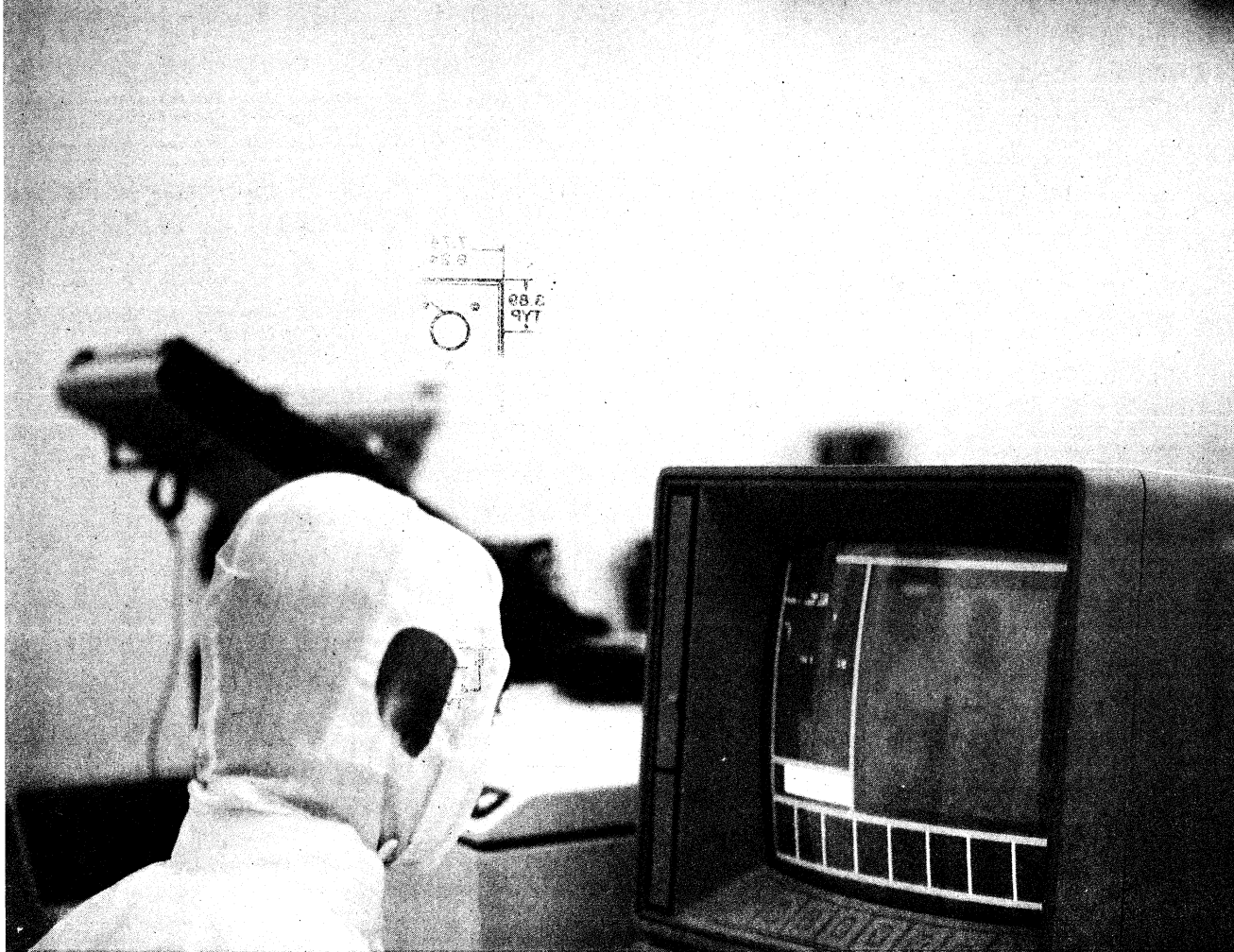

**SAMSUNG SALES OFFICES &
MANUFACTURER'S REPRESENTATIVES**

7



Page 105

Page 106

SAMSUNG SEMICONDUCTOR DISTRIBUTORS

ALABAMA

HAMMOND (205) 830-4764
4411-B Evangel Circle, N.W.
Huntsville, AL 35816

CALIFORNIA

ADDED VALUE (714) 259-8258
1582 Parkway Loop
Unit G
Tustin, CA 92680

ADDED VALUE (619) 278-1990
8361 Dickens Street
Suite 308
San Diego, CA 92111

ALL AMERICAN (800) 262-1717
369 Van Ness Way #701
Torrance, CA 90501

BELL MICRO (714) 963-0667
18350 Mt. Langley
Fountain Valley, CA 92708

BELL MICRO (408) 434-1150
550 Sycamore Drive
Milpitas, CA 95035

CYPRESS/RPS (714) 521-5230
6230 Descanso Avenue
Buena Park, CA 90620

CYPRESS/RPS (619) 535-0011
10054 Mesa Ridge Ct
Suite 118
San Diego, CA 92121

CYPRESS/RPS (408) 980-2500
2175 Martin Avenue
Santa Clara, Ca 95050

JACO/DISTEL (408) 432-9290
2880 ZANKER ROAD
SUITE 202
SAN JOSE, CA 95134

JACO/DISTEL (805) 495-9998
2260 Townsgate Road
Westlake Village, CA 91361

PACESETTER (714) 779-5855
5417 E. La Palma
Anaheim, CA 92807

PACESETTER (408) 734-5470
543 Weddel Drive
Sunnyvale, CA 94089

CANADA

ELECTRONIC WHOLESALERS (514) 769-8861
1935 Avenue De L'Eglise
Montreal, Quebec, Canada
H4E 1H2

PETERSON, C.M. (519) 434-3204
220 Adelaide Street North
London, Ontario, Canada
N6B 3H4

PRELCO (514) 389-8051
480 Port Royal St. West
Montreal, Quebec, Canada
H3L 2B9

WESTBURNE IND. ENT., LTD. (416) 635-2950
300 Steeprock Drive
Downsview, Ontario, Canada
M3J 2W9

COLORADO

ADDED VALUE (303) 422-1701
4090 Youngfield
Wheatridge, CO 80033

CYPRESS/RPS (303) 431-2622
12441 West 49th Avenue
Wheat Ridge, CO 80033

CONNECTICUT

JACO (203) 235-1422
384 Pratt Street
Meriden, CT 06450

JV (203) 469-2321
690 Main Street
East Haven, CT 06512

PILGRIM (203) 792-7274
60 Beaverbrook Road
Danbury, CT 06810

FLORIDA

ALL AMERICAN (305) 621-8282
16251 N.W. 54th Avenue
Miami, FL 33014

HAMMOND (305) 973-7103
6600 N.W. 21st. Avenue
Fort Lauderdale, FL 33309

HAMMOND (305) 849-6060
1230 W. Central Blvd
Orlando, FL 32802

GEORGIA

HAMMOND (404) 449-1996
5680 Oakbrook Parkway
#160
Norcross, GA 30093

SAMSUNG SEMICONDUCTOR DISTRIBUTORS
(Continued)

ILLINOIS

GBL/GOOLD (312) 593-3220
610 Bonnie Lane
Elk Grove Village, IL 60007

OHM (312) 359-5500
746 Vermont Avenue
Palatine, IL 60067

QPS (312) 884-6620
101 Commerce Dr. #A
Schaumburg, IL 60173

INDIANA

ALTÉX (317) 848-1323
12744 N. Meridian
Carmel, IN 46032

MARYLAND

ALL AMERICAN (301) 251-1205
1136 Taft Street
Rockville, MD 20853

JACO (301) 995-6620
Rivers Center
10270 Old Columbia Road
Columbia, MD 21046

VANTAGE (301) 995-0444
6925 Oakland Mills Road
Columbia, MD 21045

MASSACHUSETTS

AVED (617) 688-3800
200 Andover Business Park Dr.
Andover, MA 01810

GERBER (617) 329-2400
128 Carnegie Row
Norwood, MA 02062

JACO (617) 933-7760
222 Andover Street
Wilmington, MA 01887

MAYER, A. W. (617) 229-2255
34 Linnel Circle
Billerica, MA 01821

SELECT SALES (617) 821-4770
427 Turnpike Street
Canton, MA 02021

MICHIGAN

CALDER (616) 698-7400
4245 Brockton Drive
Grand Rapids, MI 49508

RS ELECTRONICS (313) 525-1155
34443 Schoolcraft
Livonia, MI 48150

MINNESOTA

ALL AMERICAN (612) 884-2220
8053 E. Bloomington Fwy
Suite 102
Minneapolis, MN 55421

VOYAGER (612) 571-7766
5201 East River Road
Fridley, MN 55421

NEW JERSEY

GRS ELECTRONICS (609) 964-8560
600 Penn St. @ Bridge Plaza
Camden, NJ 08102

JACO (201) 942-4000
Ottilio Office Complex
555 Preakness Avenue
Totowa, NJ 07512

VANTAGE (201) 777-4100
23 Sebago Street
Clifton, NJ 07013

NEW YORK

ALL AMERICAN (516) 981-3935
33 Commack Loop
Ronkonkoma, NY 11779

CAM/RPC (716) 427-9999
2975 Brighton Henrietta TL Road
Rochester, NY 14623

JACO (516) 273-5500
145 Oser Avenue
Hauppauge, NY 11788

JANESWAY (914) 699-6710
404 North Terrace Avenue
Mount Vernon, NY 10552

JANESWAY (516) 935-1827
85 Bethpage Road
Hicksville, NY 11801

MICRO GENESIS (516) 273-2600
215 Marcus Blvd.
Hauppauge, NY 11788

VANTAGE (516) 543-2000
356 Veterans Memorial Hwy.
Commack, NY 11725

NORTH CAROLINA

DIXIE (704) 377-5413
2220 South Tryon Street
Charlotte, NC 28234

HAMMOND (919) 275-6391
2923 Pacific Avenue
Greensboro, NC 27420



SAMSUNG SEMICONDUCTOR DISTRIBUTORS

(Continued)

NORTH CAROLINA (Continued)

RESCO/RALEIGH (919) 781-5700
Hwy. 70 West & Resco Court
Raleigh, NC 27612

OHIO

CAM/RPC (216) 461-4700
749 Miner Road
Cleveland, OH 44143

SCHUSTER (513) 489-1400
11320 Grooms Road
Cincinnati, OH 45242

SCHUSTER (216) 425-8134
2057D East Aurora Road
Twinsburg, OH 44087

OREGON

CYPRESS/RPS (503) 641-2233
15075 S. Koll Parkway
Suite D
Beaverton, OR 97006

OREGON (Continued)

RADAR (503) 232-3404
704 S.E. Washington
Portland, OR 97214

PENNSYLVANIA

CAM/RPC (412) 782-3770
620 Alpha Drive
Pittsburgh, PA 15238

SOUTH CAROLINA

DIXIE (803) 297-1435
4909 Pelham Road
Greenville, SC 29606

DIXIE (803) 779-5332
1900 Barnwell Street
Columbia, SC 29201

HAMMOND (803) 233-4121
1035 Lowndes Hill Rd.
Greenville, SC 29607

TEXAS

CYPRESS/RPS (214) 869-1435
2156 W. Northwest Highway
Dallas, TX 75220

JACO (214) 235-9575
1209 Glenville Drive
Richardson, TX 75080

JANESWAY (214) 437-5125
1701 N. Greenville Avenue #906
Richardson, TX 75081

OMNIPRO (214) 233-0500
4141 Billy Mitchell
Dallas, TX 75244

UTAH

ADDED VALUE (801) 975-9500
1836 Parkway Blvd.
West Valley City, UT 84119

STANDARD SUPPLY (801) 486-3371
3424 South Main Street
Salt Lake City, UT 84115

VIRGINIA

VIRGINIA ELEC. (804) 296-4184
715 Henry Avenue
Charlottesville, NC 22901

WASHINGTON

CYPRESS/RPS (206) 483-1144
22125 17th Avenue
Suite 114
Bothell, WA 98021

PRIEBE (206) 881-2363
14807 N.E. 40th
Redmond, WA 98052

RADAR (509) 943-8336
292 Torbett #E
Richland, WA 99352

RADAR (206) 282-2511
168 Western Avenue West
Seattle, WA 98119

WISCONSIN

MARSH (414) 475-6000
1563 S. 101st. Street
Milwaukee, WI 53214



SAMSUNG SEMICONDUCTOR SALES OFFICES - U.S.A.

CALIFORNIA

22837 Ventura Blvd.
Suite 305
Woodland Hills, CA 91367
(818) 346-6416

ILLINOIS

901 Warrenville Road
Suite 120
Lisle, IL 60532-1359
(312) 852-2011

MASSACHUSETTS

20 Burlington Mall Road
Suite 205
Burlington, MA 01803
(617) 273-4888

NORTH CAROLINA

2700 Augustine Drive
Suite 198
Santa Clara, CA 95054
(408) 727-7433

3200 Northline Avenue
Suite 501G, Forum VI
Greensboro, NC 27408
(919) 294-5141

TEXAS

15851 Dallas Parkway
Suite 745
Dallas, TX 75248-3307
(214) 239-0754

SAMSUNG SEMICONDUCTOR REPRESENTATIVES

U.S.A. and CANADA

ALABAMA

EMA
1200 Jordan Lane
Suite 4
Jordan Center
Huntsville, AL 35805

TEL: (205) 536-3044
FAX: (205) 533-5097

TERRIER ELEC.
3700 Gilmore Way, 106A
Burnaby, B.C., Canada
V5G 4M1

TEL: (604) 433-0159
FAX: (604) 430-0144

ARIZONA

HAAS & ASSOC. INC.
77441 East Butherus Drive
Suite 300
Scottsdale, AZ 85251

TEL: (602) 998-7195
FAX: (602) 998-7869

COLORADO

CANDAL INC.
7500 West Mississippi Ave.
Suite A-2
Lakewood, CO 80226

TEL: (303) 935-7128
FAX: (303) 935-7310

CALIFORNIA

QUEST REP INC.
9444 Farnham St.
Suite 107
San Diego, CA 92123

TEL: (619) 565-8797
FAX: (619) 565-8990

CONNECTICUT

PHOENIX SALES
257 Main Street
Torrington, CT 06790

TEL: (203) 496-7709
FAX: (203) 496-0912

SYNPAC
3945 Freedom Circle
Suite 650
Santa Clara, CA 95054

TEL: (408) 988-6988
FAX: (408) 988-5041

FLORIDA

MEC
600 W. Hillsboro Blvd.
Suite 300
Deerfield Beach, FL 33441

TEL: (305) 426-8944
FAX: (305) 426-8799

WESTAR REP COMPANY
1801 Parkcourt Place
Suite 103D
Santa Ana, CA 92701

TEL: (714) 835-4711/12/13
FAX: (714) 835-3043

MEC
375 S. North Lake Blvd.
Suite 1030
Altamonte Springs, FL 32701

TEL: (407) 332-7158
FAX: (407) 830-5436

WESTAR REP COMPANY
25202 Crenshaw Blvd.
Suite 217
Torrance, CA 90505

TEL: (213) 539-2156
FAX: (213) 539-2564

MEC
830 North Atlantic Blvd.
Suite B401
Cocoa Beach, FL 32931

TEL: (407) 799-0820
FAX: (407) 799-0923

CANADA

TERRIER ELEC.
145 The West Mall
Etobicoke, Ontario, Canada
M9C 1C2

TEL: (416) 622-7558
FAX: (416) 626-1035

GEORGIA

EMA
6695 Peachtree Ind. Blvd.
Suite 101
Atlanta, GA 30360

TEL: (404) 448-1215
FAX: (404) 446-9363

SAMSUNG SEMICONDUCTOR REPRESENTATIVES
U.S.A. and CANADA (Continued)

ILLINOIS

IRI
8430 Gross Point Road
Skokie, IL 60076
TEL: (312) 967-8430
FAX: (312) 967-5903

INDIANA

STB & ASSOC. INC.
3003 E. 96th St.
Suite 102
Indianapolis, IN 46240
TEL: (317) 844-9227
FAX: (317) 844-1904

MARYLAND

ADVANCED TECH SALES
809 Hammonds Ferry Rd.
Suite D
Linthicum, MD 21090
TEL: (301) 789-9360
FAX: (301) 789-9364

MASSACHUSETTS

JODAN TECHNOLOGY
177 Bedford St.
Lexington, MA 02173
TEL: (617) 863-8898
FAX: (617) 863-0462

MICHIGAN

JENSEN C.B.
2145 Crooks Rd.
Troy, MI 48084
TEL: (313) 643-0506
FAX: (313) 643-4735

MINNESOTA

IRI
1120 East 80th Street
Bloomington, MN 55420
TEL: (612) 854-1120
FAX: (612) 854-8312

NEW JERSEY

NECCO
2460 Lemoine Avenue
Ft. Lee, NJ 07024
TEL: (201) 461-2789
FAX: (201) 461-3857

NEW YORK

T-SQUARE
6443 Ridings Road
Syracuse, NY 13206
TEL: (315) 463-8592
FAX: (315) 463-0355

T-SQUARE
7353 Victor-Pittsford Road
Victor, NY 14564
TEL: (716) 924-9101
FAX: (716) 924-4946

NORTH CAROLINA

GODWIN & ASSOC.
1100 Logger Ct.
Suite B 102
Raleigh, NC 27609
TEL: (919) 878-8000
FAX: (919) 878-3923

GODWIN & ASSOCIATES
2812 Oak Leigh Drive
Charlotte, NC 28213
TEL: (704) 549-8500
FAX: (704) 549-9792

OHIO

BAILEY, J.N. & ASSOC.
129 W. Main Street
New Lebanon, OH 45345
TEL: (513) 687-1325
FAX: (513) 687-2930

BAILEY, J.N. & ASSOC.
2679 Indianola Avenue
Columbus, OH 43202
TEL: (614) 262-7274
FAX: (614) 262-0384

BAILEY, J.N. & ASSOC.
1667 Devonshire Drive
Brunswick, OH 44212
TEL: (216) 273-3798
FAX: (216) 225-1461

OREGON

EARL & BROWN CO.
9735 S.W. Sunshine Ct.
Suite 500
Beaverton, OR 97005
TEL: (503) 643-5500
FAX: (503) 644-9230

PENNSYLVANIA

RIVCO JANUARY INC.
RJI Building
78 South Trooper Road
Norristown, PA 19403
TEL: (215) 631-1414
FAX: (215) 631-1640

PUERTO RICO

DIGIT-TECH
P.O. BOX 1945
CALLE CRUZ #2
BAJOS, SAN GERMAN
TEL: (809) 892-4260
FAX: (809) 892-3366

SOUTH CAROLINA

EMA
210 W. Stone Avenue
Greenville, SC 29609
TEL: (803) 233-4637
FAX: (803) 242-3089

TEXAS

S.W. SALES INC.
2267 Trawood, Bldg. E3
El Paso, TX 79935
TEL: (915) 594-8259
FAX: (915) 592-0288

VIELOCK ASSOC.
720 E. Park Blvd.
Suite 102
Plano, TX 75074
TEL: (214) 881-1940
FAX: (214) 423-8556

VIELOCK ASSOC.
9600 Great Hills Trail
Suite 150-W
Austin, TX 78759
TEL: (512) 345-8498
FAX: (512) 346-4037

UTAH

ANDERSON & ASSOC.
270 South Main, #108
Bountiful, UT 84010
TEL: (801) 292-8991
FAX: (801) 298-1503

WASHINGTON

EARL & BROWN CO.
2447-A 152nd Ave. N.E.
Redmond, WA 98052
TEL: (206) 885-5064
FAX: (206) 885-2262

WISCONSIN

IRI
631 Mayfair
Milwaukee, WI 53226
TEL: (414) 259-0965

SAMSUNG SEMICONDUCTOR REPRESENTATIVES

EUROPE

AUSTRIA

ABRAHAMCZIK + DEMEL
GesmbH & Co. KG
Eichenstrabe 58-64/1
A-1120 Vienna

Tel:(0222) 857661
Tlx: 0134273
Fax: 833583

BELGIUM

NEWTEC INTERNATIONAL
Chaussee de Iouvain 186
1940 Woluwe-St-Etienne
Leuvensesteenwet 185
1940-Sint-Stevens-Woluwe

Tel:(02) 7250900
Tlx: 25820
Fax:(02) 7250813

FINLAND

**INSTRUMENTARIUM
ELEKTRONIIKKA**
P.O. Box 64, Vitikka
SF-02631 Espoo
Helsinki Finland

Tel:(358)05284320
Tlx: 124426
Fax:(358)0524986

FRANCE

ASIAMOS
Batiment EVOLIC 1
155 Boulevard de Valmy
92705 Colombes, France

Tel: (1) 47601255
Tlx: 613890F
Fax:(1)47601582

GERMANY (WEST)

SILCOM ELEKTRONICS
Neusser Str. 336-338
D-4050 Muchengladbach

Tel: (02161) 60752
Tlx: 852189

**MICRONETICS VERTRIEBS-
GESELLSCHAFT
ELEKTRONISCHER
BAUELEMENTS and SYSTEME GmbH**
Weil der Stadter Strabe 45
7253 Renningen 1

Tel: (07159) 6019
Tlx: 724708

ING. THEO HENSKES GmbH
Laatzener Str. 19
Postfach 721226
30000 Hannover 72

Tel:(0511) 865075
Tlx: 923509
Fax: 876004

ASTRONIC GmbH
Winzener Str. 47d
8000 Munchen 40

Tel:(089) 309031
Tlx: 521687
Fax:(089)3006001

ITALY

MOXEL S.P.A.
20092 Cinisello Balsamo (MI)
Via C. Frova. 34

Tel:(02) 61290521
Tlx: 352045
Fax: (02) 6172582

DIS. EL S.R.L.
10148 Torino
Via Ala di Stura 71/18

Tel: (220) 1522345
Tlx: 215118

NETHERLANDS

BY HANDELMIJ. MALCHUS
Fokkerstratt 511-513
Postbus 48
NL-3100 AA Schiedam

Tel:(010) 373777
Tlx: 21598

SPAIN

SEMICONDUCTORES S.A.
Ronda General Mitre, 240
Barcelona-6

Tel: (93) 2172340
Tlx: 97787 SMCD E
Fax: 2175698

SANTOS DEL VALLE, S.A.
Galileo, 54, 56
28015 Madrid

Tel:(91)4468141/44
Tlx: 42615 LUSA E.

SWEDEN

NORDISK ELEKTRONIK AB
Huvudstagatan 1 Box 1409
5-17127 Solna

Tel:(08)7349770
Tlx: 10547
Fax:(08) 272204

SWITZERLAND

PANATEL AG
Hardstrabe 72
CH-5430 Wettingen Zurich

Tel:(056)275275
Tlx: 58068
Fax: (056) 271924

UNITED KINGDOM

KORD DISTRIBUTION LTD.
Watchmoor Road, Camberley
Surrey GU153AQ

Tel: 0276 685741
Tlx: 859919
KORDIS G.

BYTECH LTD.
2 The Western Centre
Western Road
Bracknell Berkshire RG121RW

Tel: 0344 482211
Tlx: 848215

RAPID SILICON
Rapid House Denmark Street
High Wycombe
Buckinghamshire HP 11 2 ER

Tel: 0494 26271
Sales hot line: 0494 442266
Tlx: 837931
Fax: 0494 21860

SAMSUNG SEMICONDUCTOR REPRESENTATIVES

ASIA

HONG KONG

AV. CONCEPT

Hunghom Commercial Centre,
Room 708, Tower A 7/F
37-39, Ma Tau Wai Road
Hunghom, Kowloon, Hong Kong
Tel: 3-629325~6, 3-347722~3
Tlx: 52362 ADVCC HX
Fax: 852-3-7234718

PROTECH COMPONENT

FLAT 3 10/F WING SHING IND. BLDG.
26 NG FONG ST, SANPOKONG
KOWLOON, Hong Kong
Tel: 3-255106
Tlx: 38396 PTL D HX
Fax: 852-3-7988459

TRIATOMIC ENTERPRISES

Room 2001A Nan Fung Center
264-298, Castle Peak Road
Tusen Wan, New Territories.
Tel: 0-4121332
Fax: 0-4120199

MATSUDA ELECTRONICS

6/F CHUNG PAK Commercial BLDG.
2 Cho Yuen St. Yau Tong Bay
Kowloon, Hong Kong
Tel: 3-7276383
Tlx: 42349 MAZDA HX
Fax: 852-3-7989661

JERS ELECTRONICS COMPANY

14/F, Houtex Industrial BLDG.
16 Hung To Road, Kwan Tong Kowloon
Hong Kong
Tel: 3-418311-8
Tlx: 55450 JERSE HX
Fax: 852-3-438712

TAIWAN

YOSUN INDUSTRIAL CORP.

MIN SHENG Commercial BLDG.
10F., No. 481, MIN-SHENG EAST RD.,
TAIPEI, TAIWAN, R.O.C.
Tel: 501-0700 (10 LINES)
Tlx: 26777 YOSUNIND
Fax: (02) 503-1278

KENTOP ELECTRONICS CO., LTD.

5F-3, 21st CENTURY BLDG.,
NO. 207, TUN-HWA N. RD., TAIPEI
Tel: (02) 716-1754, 716-1757
Fax: (02) 717-3014

JAPAN

ADO ELECTRONIC INDUSTRIAL CO., LTD.

7th FL., SASAGE BLDG. 4-6 SOTOKANDA
2-CHOME CHIYODA-KU, TOKYO 101, JAPAN
Tel: 03-257-1618
Fax: 03-257-1579

INTERCOMPO INC.

IHI BLDG, 1-6-7, SHIBUYA, SHIBUYA-KU
TOKYO 150 JAPAN
Tel: 03-406-5612
Fax: 04-409-4834

CHEMI-CON INTERNATIONAL CORP.

MITSUYA TORANOMON BLDG.
22-14, TORANOMON 1 CHOME
MINATO-KU TOKYO 105, JAPAN
Tel: 03-508-2841
Fax: 03-504-0566

TOMEN ELECTRONICS CORP.

1-1, USCHISAIWAI-CHO 2 CHOME
CHIYODA-KU TOKYO, 100
Tel: 03-506-3473
Fax: 03-506-3497

DIA SEMICON SYSTEMS INC.

WACORE 64 1-37-8 SANGENJAYA
SETAGAYA-KU TOKYO 154 JAPAN
Tel: 03-487-0386
Fax: 03-487-8088.

RIKEI CORP.

NICHIMEN BLDG. 2-2-2 NAKANOSHIMA
KITA-KU OSAKA 530 JAPAN
Tel: 06-201-2081
Fax: 06-222-1185

SINGAPORE

GEMINI ELECTRONICS PTE LTD.

100, UPF-R CROSS STREET
#09-08 OG BLDG. SINGAPORE 0105
Tel: 65-5351777
Tlx: RS 42819
Fax: 65-5350348

INDIA

MURUGAPPA ELECTRONICS LTD.

PARRRY HOUSE 3rd floor 43 Moore Street
MADRAS 600 001 India
Tel: 21019/31003
Tlx: 041-8797 HIL IN.

7

SAMSUNG SEMICONDUCTOR REPRESENTATIVES

KOREA

NAEWAE ELECTRIC CO., LTD.

Room 403, 22Dong Sumin Bldg,
#16-1, Hangangro-2ka, Yongsanku,
Seoul Korea.
Tel: 701-7341~5
Fax: 717-7246

**SAMSUNG
LIGHT-ELECTRONICS CO., LTD.**

149-Jang Sa Dong
Jongroku, Seoul Korea
Tel: 744-2110, 269-6187/8
Fax: 744-4803

SEGYUNG ELECTRONICS

182-2 Jang Sa Dong
Jongroku, Seoul Korea
Tel: 272-6811~6
Fax: 273-6597

**NEW CASTLE
SEMICONDUCTOR CO., LTD.**

123-1, Joo Kyo Dong
Joongku, Seoul Korea
Tel: 274-3220, 3458

HANKOOK SEMICONDUCTOR

1131-9 Kurodong, Kuroku,
Seoul Korea
Tel: 868-0277~9
Fax: 868-4604